

Orion StarBlast™ 6/6i IntelliScope Reflector

#10016 / #27191



 **ORION**
TELESCOPES & BINOCULARS
Providing Exceptional Consumer Optical Products Since 1975

OrionTelescopes.com
Customer Support (800)676-1343
E-mail: support@telescope.com
Corporate Offices (831) 763-7000
89 Hangar Way, Watsonville, CA 95076

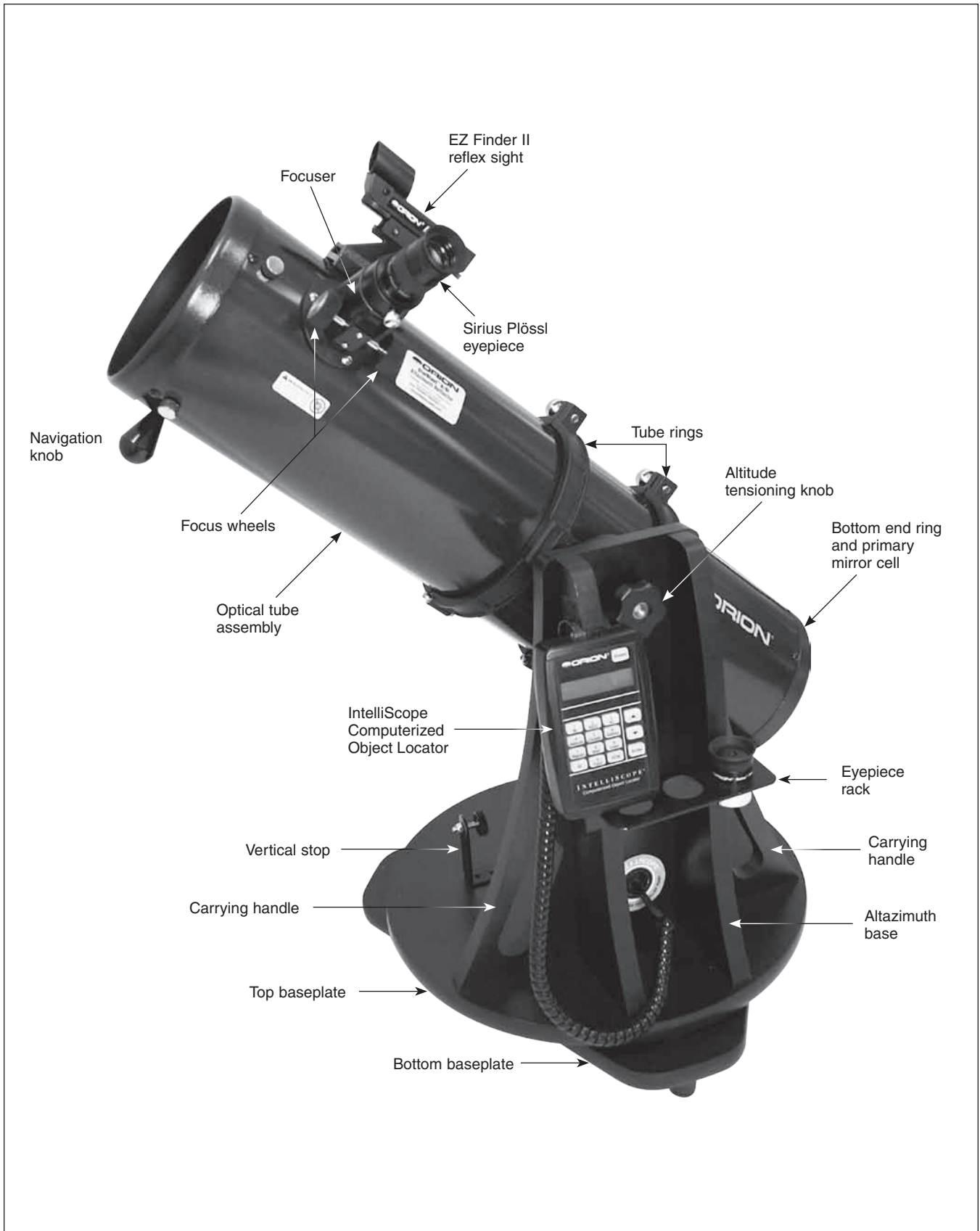

Figure 1. The StarBlast 6/6i, shown with IntelliScope system installed (#27191)

Congratulations on your purchase of an Orion StarBlast 6/6i IntelliScope Reflector telescope! It is a versatile and compact astronomical instrument designed to provide wondrous views of celestial objects while offering unprecedented ease of use.

These instructions apply to both the StarBlast 6 (#10016, without IntelliScope Computerized Object Locator) and the StarBlast 6i (#27191), which includes the IntelliScope system. If you purchased the StarBlast 6 (#10016), you may always add the IntelliScope system (#27926) later to enjoy full digital object location capability.

NOTE: The original model of the StarBlast 6 (#9964) is not compatible with the IntelliScope Computerized Object Locator.

If you purchased the #10016 StarBlast 6, you will enjoy breathtaking views of the Moon, planets, and even deep-sky objects like the Orion Nebula. The telescope's precision Newtonian optics; portable, user-friendly design; and complement of outstanding features and accessories will make stargazing easy and fun for the whole family.

If you purchased the #27191 StarBlast 6i IntelliScope, viewing the night sky will be even easier, as you will have the ability to pinpoint and view thousands of celestial objects with the push of a button. Searching for objects will not be necessary because the IntelliScope's high-resolution digital encoders will find them for you, in seconds!

Either way, we hope you enjoy your journey through the universe!

These instructions will help you set up and use your StarBlast 6/6i telescope, please read them thoroughly.

WARNING: *Never look at the sun with your telescope (or even with just your eyes) without a professionally made solar filter. Permanent eye damage or blindness could result. Young children should use this telescope only with adult supervision.*

Avoid using the type of solar filter that screws into an eyepiece. They are susceptible to cracking under the intense heat that builds up near the focus point, and could cause severe retinal damage. Use only the type of solar filter that covers the front of the telescope. Also, be sure to leave the cover caps on the finder scope when solar observing. Better yet, remove the finder scope altogether when viewing the sun.

Table of Contents

1. Unpacking	4
2. Parts List	4
3. Assembly of #10016 StarBlast 6 (without IntelliScope system)	6
4. Assembly of #27191 StarBlast 6i IntelliScope	6
5. Final Assembly of Your Telescope (StarBlast 6/6i)	11
6. Preparing to Use Your Telescope	12
7. Observing With Your Telescope	13
8. Using the IntelliScope Computerized Object Locator	16
A. Alignment	16
B. Overview of the IntelliScope Computerized Object Locator	18
C. Locating the Planets	19
D. Locating Deep-Sky Objects by Catalog	20
E. Locating Deep Sky Objects by Object Type	21
F. Locating Stars	22
G. Tours of the Best Objects	23
H. The Identify Function	23
I. Adding User-Defined Objects	24
J. The Function (FCN) Button	24
K. The "Hidden" Functions	25
9. Care and Maintenance	26
10. Specifications of the StarBlast 6/6i	27
11. Specifications of the IntelliScope System	27
Appendix A: Collimating the Optics	28
Appendix B: Cleaning the Optics	31
Appendix C: Troubleshooting the IntelliScope System	31
Appendix D: Alignment Star Finder Charts	34
Appendix E: Constellation Abbreviations	38
Appendix F: ST Catalog	39

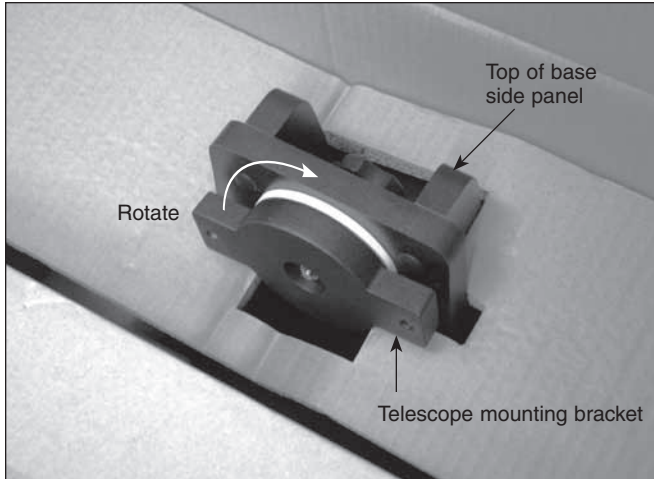

Figure 2. To remove the cardboard insert from atop the altazimuth base, rotate the telescope mounting bracket so its long axis is vertically oriented, then lift the insert off.

1. Unpacking

Carefully unpack the StarBlast 6/6i from its shipping box. We recommend keeping the original shipping box and any smaller accessory boxes contained within it. In the event that the telescope needs to be shipped to another location, or returned to Orion for warranty repair, having the proper shipping containers will help ensure that your telescope will survive the journey intact.

To remove the foam insert from the top of the altazimuth base, rotate the telescope mounting bracket so that its long axis is oriented vertically, then lift the foam insert out of the box (**Figure 2**).

Make sure all the parts in the Parts List below are present. Be sure to check the boxes carefully, as some parts are small. If anything appears to be missing or broken, immediately call Orion Customer Support (800-676-1343) for assistance.

2. Parts List

Qty.	Description
1	Optical tube assembly
1	Altazimuth base
1	Tube rings, pair
1	Optical tube dust cover
1	25mm Sirius Plössl eyepiece,
1	10mm Sirius Plössl eyepiece

- 1 EZ Finder II reflex sight
- 1 Collimation cap
- 1 3-Hole eyepiece rack
- 1 Hex key, or Allen wrench (size 3/16")

The following parts are packed in small plastic bags inside the main telescope box. They are needed only for the StarBlast 6i IntelliScope model (#27191), not for the StarBlast 6 (#10016) without IntelliScope. If you purchased the latter, please do not discard these parts! Should you decide at a later date to add the IntelliScope Computerized Object Locator (#27926), you will need these parts. Keep them in a safe place.

- 1 Azimuth encoder board
- 1 Azimuth encoder disk
- 1 Vertical stop L-bracket
- 1 Vertical stop bolt (with knob)
- 1 Jam nut for vertical stop bolt
- 1 Brass azimuth bushing
- 1 Aluminum spacer ring
- 3 Machine screws, 5mm (<1/4") long
- 6 Wood screws, 12mm (~1/2") long
- 2 Machine screws, 25mm (~1") long
- 2 Small hex nuts (for 25mm machine screws)
- 2 Small flat washers (for 25mm machine screws)
- 2 Small lock washers (for 25mm machine screws)

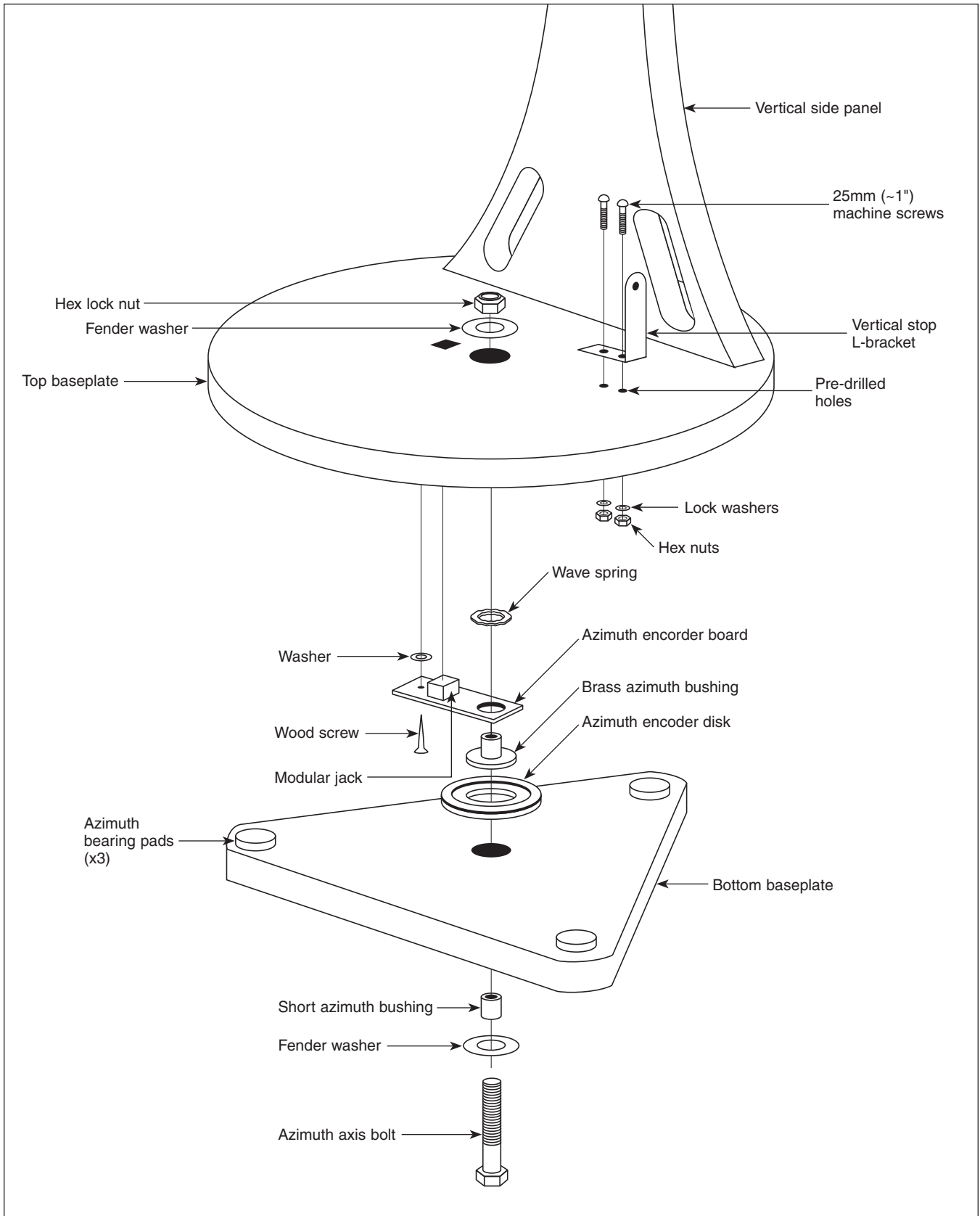

Figure 3. Illustration showing correct placement of the azimuth components of the IntelliScope system on the altazimuth base.

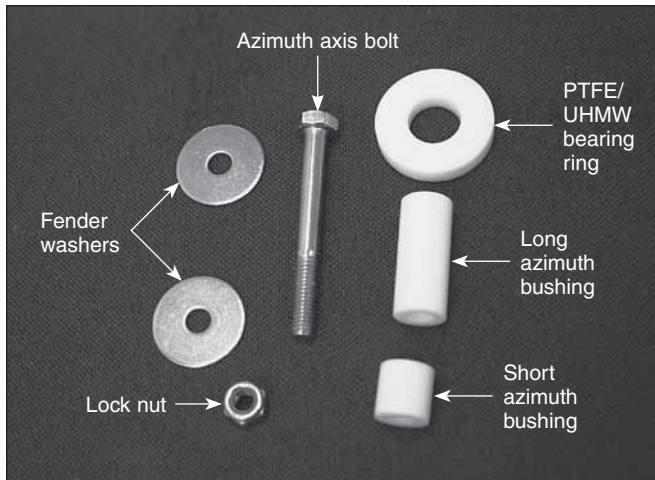

Figure 4. When you disassemble the top and bottom baseplates, you should see all of these parts.

The following parts are included in the small box containing the IntelliScope Computerized Object Locator that comes with the StarBlast 6i IntelliScope model (#27191) only. They are not included or needed with the standard StarBlast 6 (#10016).

- 1 Computerized Object Locator
- 1 Altitude encoder board
- 1 Encoder connector board
- 1 Altitude encoder disk
- 1 Coil cable
- 1 Altitude encoder cable (shorter)
- 1 Azimuth encoder cable (longer)
- 1 Wood screw, 1/2" long
- 8 Washers, 5/16" diameter
- 1 Wave spring
- 1 Compression spring
- 4 Cable retaining clips
- 2 Hook-and-loop strips (1 "hook" strip, 1 "loop" strip)
- 9-volt battery

3. Assembly of #10016 StarBlast 6 (without IntelliScope system)

The StarBlast 6/6i is partially assembled at the factory, for your convenience. The altazimuth base is fully pre-assembled in the #10016 configuration; that is, it is ready for use without the IntelliScope system. If you purchased the #10016 StarBlast 6, please skip to section 5: "Final Assembly of Your Telescope (StarBlast 6/6i)."

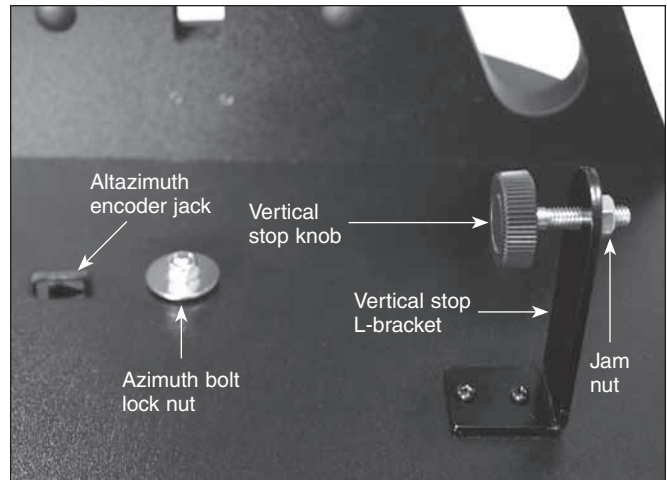

Figure 5. The vertical stop L-bracket and bolt (with knob), shown installed in their correct orientations. The jam (hex) nut on the opposite side of the L-bracket from the knob locks the vertical stop bolt in the desired position.

4. Assembly of #27191 StarBlast 6i IntelliScope

If you purchased the #27191 StarBlast 6i IntelliScope, some assembly is required to install the components of the IntelliScope system on the altazimuth base. In fact, you will first have to disassemble a portion of the base to remove a couple of parts and install others that are necessary for the IntelliScope system of function properly.

Installation of the IntelliScope System on the Altazimuth Base

The assembly requires a small and a medium-sized Phillips screwdriver and two adjustable crescent wrenches. You can substitute a pair of pliers for one of the adjustable crescent wrenches. You will also need a small (4" or so) piece of duct tape, masking tape, or packing tape.

When tightening screws, tighten them until firm, but be careful not to strip the threads by over-tightening.

Begin by placing the pre-assembled altazimuth base on the floor or a table. For steps 1-11, refer to the schematic illustration in **Figure 3** for correct placement of components.

1. To prepare the base for the installation of the IntelliScope system components, you must first disassemble the top baseplate from the bottom baseplate. To do this, use one adjustable crescent wrench or a pair of pliers to hold the hex head of the azimuth axis bolt steady on the underside of the bottom baseplate while using another adjustable crescent wrench to turn the hex lock nut on the other end of the bolt. Remove the lock nut and metal fender washer and set them aside. Now carefully separate the two baseplates. In addition to the azimuth axis bolt and a fender washer on the underside of the

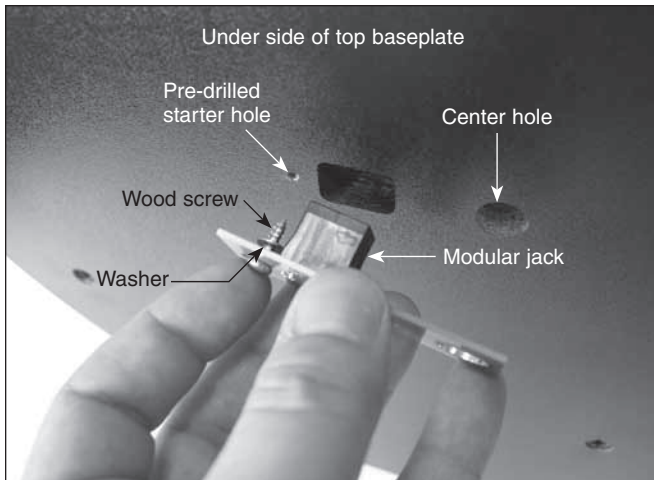

Figure 6. Install the azimuth encoder board on the underside of the top baseplate. Be sure to place one washer on the screw after inserting the screw through its hole in the azimuth board, then thread the screw into the predrilled starter hole.

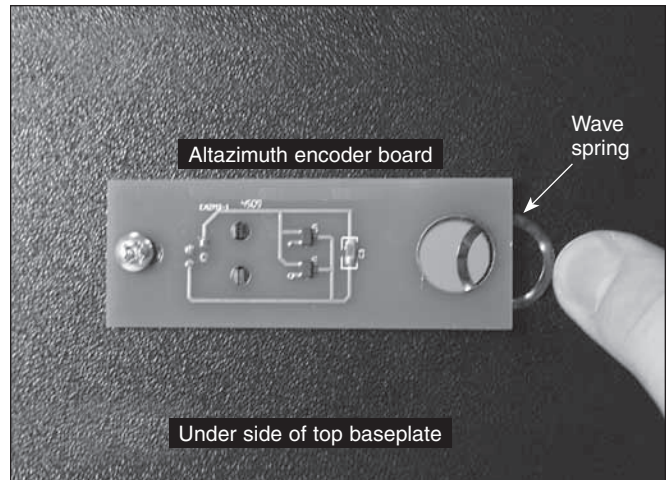

Figure 7. Wedge the wave spring between the azimuth encoder board and the baseplate and align the “hole” in the wave spring with the central hole in the baseplate.

bottom baseplate, you should also see three white plastic parts: a short azimuth bushing, a long azimuth bushing, and a flat PTFE/UHMW bearing ring (**Figure 4**). The bushings may have remained lodged in the center hole of the baseplate(s) when you removed it. If that’s the case, use a finger to push the bushing out of the hole. Set the bottom baseplate and associated parts aside for now while you install the vertical stop L-bracket on the top baseplate.

2. Install the vertical stop L-bracket. It will be permanently installed on the top baseplate (**Figure 5**). The vertical stop L-bracket will be used before each observing session to set the precise vertical orientation of the optical tube, the procedure for which will be described later. Once installed, the L-bracket will never have to be removed because it does not interfere with the range of motion of the optical tube between vertical and horizontal positions.

To install the vertical stop L-bracket, insert the two 25mm (~1”) machine screws through the two holes in the L-bracket’s foot. Then insert the screws into the holes in the top baseplate, with the L-bracket oriented as shown in **Figure 5**. On the underside of the top baseplate, place a small lock washer on the end of each screw, then thread on a small hex nut. While holding the hex nut stationary with two fingers, tighten the screw with a small Phillips screwdriver. Repeat for the other screw. Now the L-bracket is secured in place.

Note: You may discard the two small flat washers for the 25mm machine screws that were included in the hardware kit; they are not needed.

3. Thread the vertical stop bolt and knob into the corresponding hole in the vertical stop bracket, in the orientation show in **Figure 5**. Thread it though so that 1/2” or so of the bolt emerges on the other side of the L-bracket, then thread on the jam nut. You will adjust the position of the vertical stop bolt and tighten the jam nut later, when initializing the IntelliScope system prior to using it for the first time.
4. Attach the azimuth encoder board to the underside of the top baseplate (**Figure 6**). Insert a wood screw through the slot in the azimuth encoder board, then place a washer over the tip of the screw. Now hold the encoder board so that the modular jack and large hole in the encoder board line up with their corresponding holes in the baseplate. Insert the screw tip into the pre-drilled starter hole and screw it in with a Phillips screwdriver until just tight. The screw should not be fully tightened; it should be tight, but not tight enough to prevent the encoder board from moving in its slot.
5. Place the wave spring between the azimuth encoder board and the bottom of the top baseplate as shown in **Figure 7**. Position the wave spring so that it aligns precisely with the central hole in the baseplate.

Now that the azimuth encoder is installed on the underside of the top baseplate, be sure not to set the baseplate down on a flat surface, as doing so could damage the encoder. Rather, set the baseplate with attached vertical side panel assembly on its side for now.

6. Place one fender washer on the azimuth axis bolt, followed by the short nylon bushing. Then insert the bolt through the central hole from the underside of the bottom

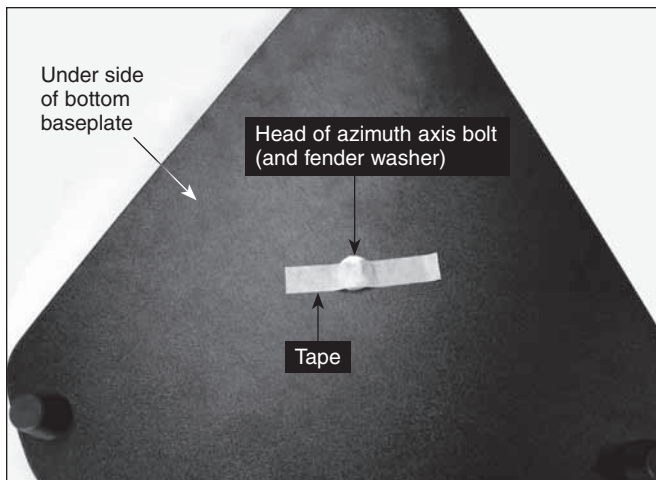

Figure 8. Placing a piece of duct, masking, or packing tape over the hex head of the azimuth axis bolt will keep it from dropping downward when you replace the top baseplate onto the bottom baseplate.



Figure 9. To reassemble the baseplates, tilt them only slightly, as shown. Do not place them on their side. Use one wrench to hold the azimuth axis bolt head steady while turning the hex lock nut with the other wrench.

baseplate. Make sure the short nylon bushing seats up into the hole.

7. Now temporarily place a piece of duct tape, masking tape, or packing tape over the head of the azimuth axis bolt (**Figure 8**). This will keep the bolt from sliding down as you install the top baseplate, which you will do in step 10.
8. Place the azimuth encoder disk, flat side down, over the azimuth axis bolt and rest it on the bottom baseplate. Make sure you've got the correct encoder disk! The azimuth encoder disk has a smaller center hole than the altitude encoder disk.
9. Place the brass bushing onto the azimuth axis bolt so that the wide end of the bushing is closest to the encoder disk. Seat the bushing onto the encoder disk so that the registration feature on the bushing goes into the hole in the encoder disk. You may need to move the encoder disk around on the azimuth axis bolt a bit for the bushing to seat properly.

*Note that for the IntelliScope version (#27191) of this telescope, you will not need the long nylon azimuth bushing and PTFE/UHMW bearing disk that you removed during the baseplate disassembly (**Figure 4**). Those parts are only utilized for the non-IntelliScope version of the StarBlast 6 (#10016).*

10. Carefully position the top baseplate over the bottom baseplate and lower it so the brass bushing goes up into

the center hole of the top baseplate. Place the remaining fender washer onto the shaft of the azimuth axis bolt, then thread the hex lock nut onto the end of the bolt and tighten it only finger tight, for now. *Note that the brass bushing protrudes slightly above the surface of the top baseplate. This is by design.*

11. Tilt the assembled base at a slight angle (as little as possible) and remove the tape from underneath the bottom baseplate. Now, with one wrench (or pliers) hold the head of the azimuth axis screw still while turning the hex lock nut with the other wrench (**Figure 9**). Tighten the hex lock nut just until the top fender washer is no longer loose, then tighten the hex nut $3/16$ to $1/4$ turn beyond that. This ensures proper spacing between the encoder disk and the azimuth encoder board.
12. Attach the encoder connector board to the side panel. Place a wood screw into each of the four holes of the connector board and then a washer onto each screw. Sliding the washers all the way down on the screw shaft should help keep the screws from falling out while installing the board. Still, the installation may take a bit of dexterity, so don't get frustrated if it takes a couple tries. Align the screw tips with the four pre-drilled holes in the side panel so that the modular jack fits into the rectangular cutout. Then thread the screws into the holes with a screwdriver. See **Figure 10**.

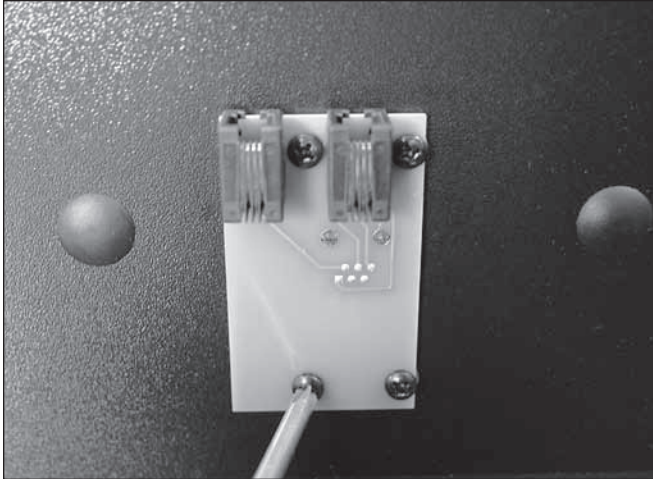

Figure 10. Installing the encoder connector board. There is a washer on each screw, between the encoder board and the side panel.

13. To attach the altitude encoder board and altitude encoder disk, you must first remove the telescope mounting bracket. Rotate the altitude axis tensioning knob counterclockwise and remove it completely. You'll see two flat washers and a ball bearing ring remaining on the mounting bracket's shaft. To remove them you have to rotate the outer washer counterclockwise to "unthread" it from the bolt shaft, then slide the ball bearing ring and inside washer off of the shaft. Now remove the telescope mounting bracket from the side panel.
14. Insert the compression spring into the hole just below the hole for the altitude axis bolt on the inside surface of the side panel. When inserted as far as it will go, the spring will still protrude from the hole by several millimeters (**Figure 11**).
15. Now you will install the altitude encoder board. Place two wood screws through the mounting holes in the board, and then place two washers over the screw tips as shown in **Figure 12a**. Thread the screws into the pre-drilled mounting holes with a Phillips screwdriver until the board is secured, making sure that the large hole in the encoder board is aligned with the hole in the side panel and the board is pressing squarely against the compression spring that you installed in the previous step (**Figure 12b**). The screws should not be fully tightened; they should be tight, but not tight enough to prevent the altitude encoder from moving up and down within the slots in the encoder board.

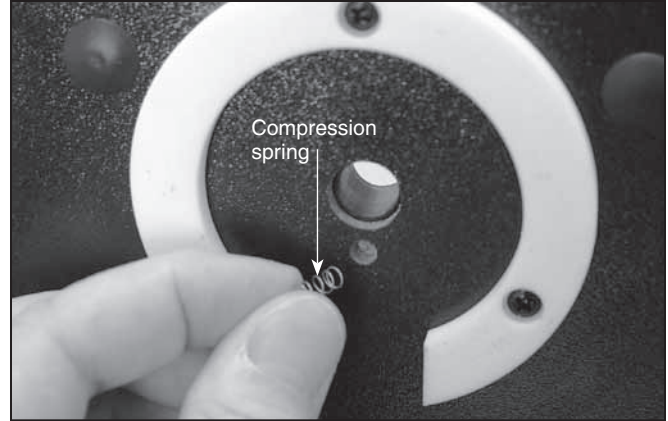

Figure 11. Insert the compression spring into the small hole just below the larger hole for the altitude axis bolt.

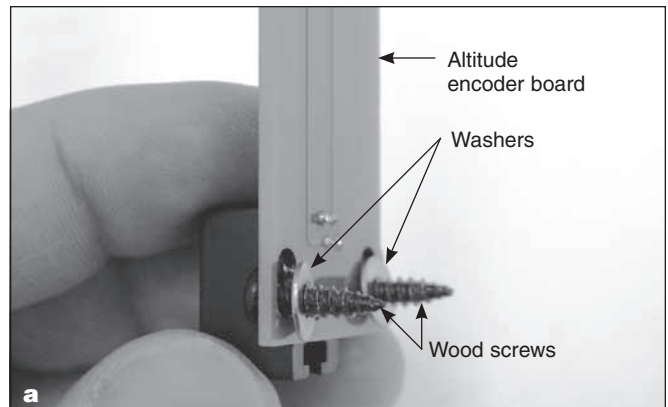

Figure 12. (a) Installing the altitude encoder board. Place a washer on each screw, as shown. **(b)** The altitude encoder board installed.

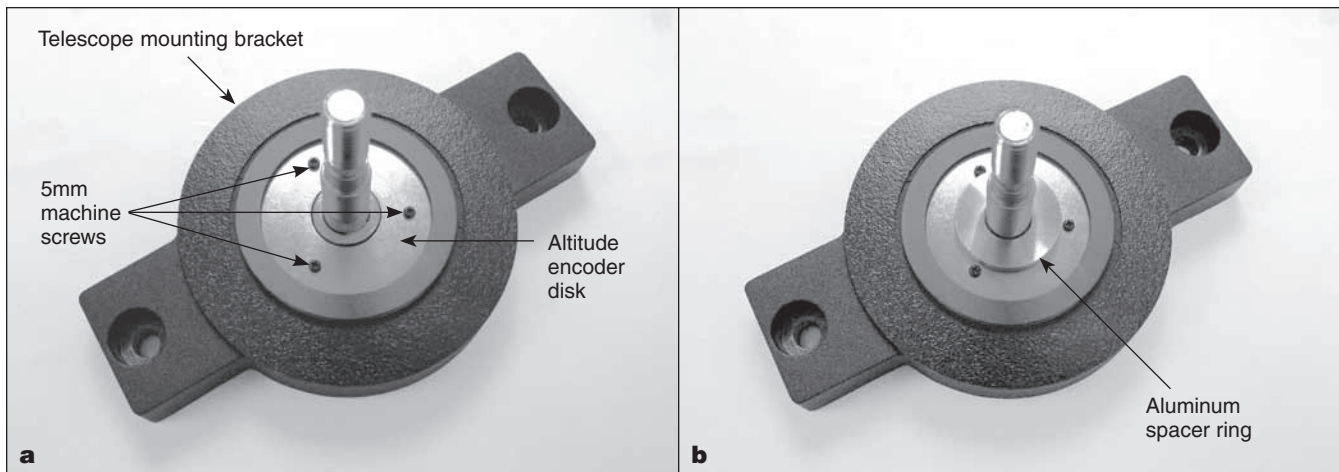

Figure 13. (a) The altitude encoder disk is attached to the telescope mounting bracket with three 5mm machine screws. The disk fits just inside the Ebony Star bearing ring. **(b)** The aluminum spacer ring should be installed on the telescope mounting bracket's shaft (altitude axis bolt) such that the flat side of the ring faces outward.

16. Attach the altitude encoder disk to the telescope mounting bracket with the three 5mm (~1/4") machine screws (**Figure 13a**). Place the aluminum spacer ring on the telescope mounting bracket shaft with the flat side of the ring facing outward (the opposite side has an indentation around the hole). See **Figure 13b**. Then carefully insert the shaft through the hole in the altitude encoder board and then the hole in the side panel. You may have to carefully rotate the shaft back and forth a little to get it through the hole, as it is a tight fit. Slide the inside washer and ball bearing ring (which you removed in step 13) onto the shaft, then "thread on" the outer washer followed by the altitude tensioning knob.
17. Lastly, connect the encoder cables and install the cable retaining clips. Refer to **Figure 14** for proper placement. Connect one end of the azimuth encoder cable (the longer of the two cables) to the encoder jack in the top baseplate. Connect the other end to the encoder connector board on the side panel. The cable should plug into the jack on the right side of the encoder connector board.

Plug one end of the altitude encoder cable into the modular jack on the altitude encoder board. Connect the other end of the cable to the jack on the left side of the encoder connector board.

Use the provided cable retaining clips to secure the altitude and azimuth cables neatly to the base. We recommend using one clip for the (shorter) altitude cable, and two clips for the (longer) azimuth cable (**Figure 14**). The clips have adhesive backing; simply peel the paper off the back of the clip and press the adhesive back to the base where you want the clip to be located.

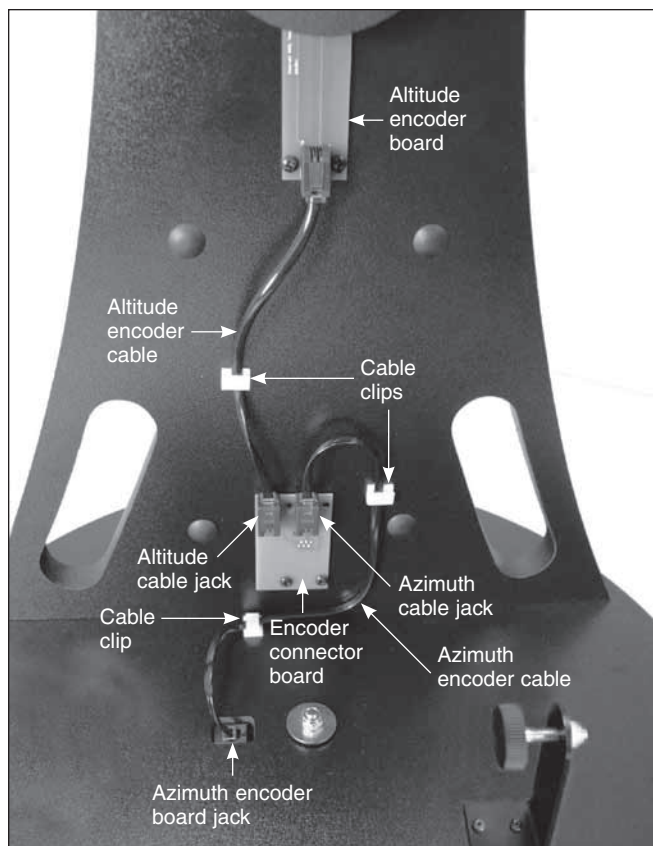

Figure 14. Connect the two encoder cables as shown.

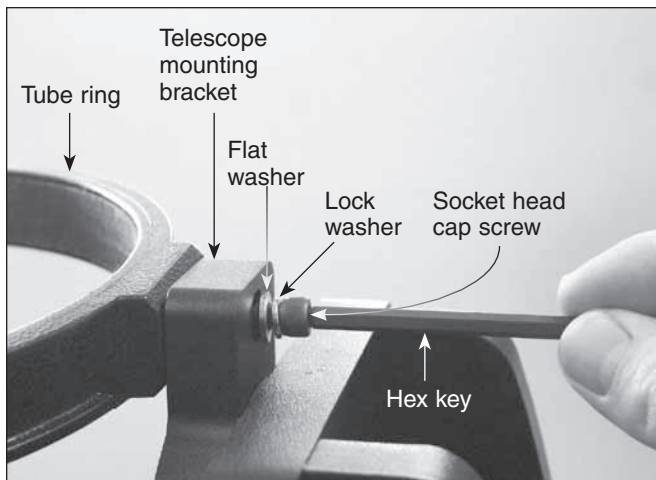

Figure 15. Attaching a tube ring to the telescope mounting bracket.

5. Final Assembly of Your Telescope (StarBlast 6/6i)

Now you will complete the assembly of your telescope by installing the tube rings and optical tube assembly on the altazimuth base and attaching the included accessories.

Before getting started, locate the following items:

Qty.	Description
1	Optical tube assembly
2	Tube rings
1	Telescope mounting bracket
1	EZ Finder II reflex sight
1	25mm Sirius Plössl eyepiece
1	10mm Sirius Plössl eyepiece
1	Eyepiece rack
2	Socket-head cap screws w/washers (on tube rings)

Attach the Optical Tube to the Base

To attach the optical tube assembly to the altazimuth base you will first need to equip the telescope mounting bracket with the two tube rings. Rotate the bracket so one of the two through holes in the bracket is accessible (**Figure 15**). Place a lock washer and then a flat washer onto each of the socket-head cap screws. Then insert the screw into the through hole as shown in **Figure 15** and thread it into one of the two tube rings using the included hex key. Do not tighten it all the way; you'll do that after the telescope tube has been secured in the tube rings. Now rotate the bracket 180° so the other through hole is accessible. Fasten the second tube ring to the bracket with the remaining washer-equipped screw using the hex key. Again, don't tighten the screw completely yet. Be sure to orient the



Figure 16. Attach the EZ Finder II in its dovetail base in the orientation shown.

tube rings so that the knurled ring clamps are on the same side.

Open the tube rings by loosening the knurled ring clamps. Place the optical tube assembly in the open rings so the front (open) end of the tube points upward. While grasping the optical tube firmly, close the rings around the tube and loosely tighten the knurled ring clamps. Adjust the position of the optical tube in the tube rings so the bottom end of the tube just clears the hardware in the center of the top baseplate.

To view through the StarBlast 6/6i comfortably, you can adjust the orientation of the focuser by rotating the optical tube within the tube rings. Loosen the knurled ring clamps on the tube rings by a few turns. Now, gently rotate the optical tube within the tube rings until the focuser is oriented to your liking. Then tighten the knurled ring clamps to secure the optical tube in that position.

Now that the optical tube is secured tightly in the tube rings, tighten up each of the two socket-head cap screws that fasten the tube rings to the telescope mounting bracket using the hex key.

Install the EZ Finder II Reflex Sight

Slide the foot of the EZ Finder II bracket into the dovetail base that is pre-installed on the optical tube (**Figure 16**). The EZ Finder II should be oriented as in the figure. Tighten the thumbscrew on the dovetail base to secure the EZ Finder II in place. *If it is present, remove the thin plastic battery shield tab (not shown) from the battery casing prior to use and discard it.*

Install the Eyepiece Rack

The eyepiece rack can be installed so that it can be removed, or so it is permanently attached. Place the large portion of the eyepiece rack's "keyhole" mounting slots over the two pre-installed Phillips head screws on the side of the altazimuth base, then slide the rack downward. If you want to be able to remove the rack for transport or storage of the telescope, be sure the screws are loose enough so you can lift the rack and remove it from the base through the large opening of the "keyhole." If you wish to permanently attach the rack to the

base, tighten the two screws with a screwdriver until the rack is secured in place.

Insert an Eyepiece

Remove the small cap covering the focuser drawtube and loosen the two eyepiece locking thumbscrews on the drawtube collar. Insert the chrome barrel of the 25mm Sirius Plössl eyepiece into the focuser and secure it with the thumbscrews. You can place the 10mm Sirius Plössl eyepiece in the eyepiece rack for use later.

Congratulations! Your telescope is now fully assembled. Remove the dust cap from the front of the telescope when it is in use. Replace it when you are finished observing.

6. Preparing to Use Your Telescope

This section applies to both the StarBlast 6 (#10016) and StarBlast 6i IntelliScope (#27191).

It's best to get a feel for the basic functions of the StarBlast 6/6i during the day, before observing astronomical objects at night. This way you won't have to orient yourself in the dark! Find a spot outdoors where you'll have plenty of room to move the telescope, and where you'll have a clear view of some object or vista that is at least 1/4 mile away. It is not critical that the altazimuth base be exactly level (except when initially setting the vertical stop knob position on the StarBlast 6i IntelliScope), but it should be somewhat level to ensure smooth movement.

The StarBlast 6/6i was designed specifically for visual observation of astronomical objects in the night sky. Like all Newtonian reflector telescopes, it is not well suited for daytime terrestrial usage because the image in the eyepiece will be rotated somewhat from the normal, naked-eye view.

Placing the StarBlast 6/6i for Comfortable Viewing

One of the great assets of the StarBlast 6/6i is its extremely portable size. Due to its overall short length, you will find that viewing while sitting next to the telescope is the most comfortable. If you wish to raise the telescope off the ground so that it can be used while standing or sitting in a chair, then a platform, such as a milk crate, sturdy table, or the hood of a car can be used.

Altitude and Azimuth (Aiming the Telescope)

The StarBlast 6/6i's altazimuth base permits motion along two axes: altitude (up/down) and azimuth (left/right). See **Figure 17**. Moving the telescope up/down and left/right is the "natural" way people aim objects, which makes pointing the telescope intuitive and easy.

Simply take hold of the navigation knob and push or pull it to move the telescope and base in the desired direction. Both the altitude and azimuth motions can be made simultaneously and in a continuous manner for easy aiming. This way you can point to any position in the night sky, from horizon to horizon.



Figure 17. The StarBlast 6/6i has two axes of motion: altitude (up/down) and azimuth (left/right).

You may find it convenient to hold one hand on one of the carrying handles to help in leveraging the base while moving and aiming the telescope.

When aiming the telescope in altitude, you may find the optical tube assembly is either too hard to move or does not stay in place. Use the altitude tension knob to adjust the friction on the altitude axis until you achieve the desired amount. Ideally, you should adjust the tension on the altitude axis so that the amount of friction roughly matches that of the azimuth axis (which is not adjustable).

Focusing the Telescope

With the 25mm Sirius Plössl eyepiece in the focuser, aim the optical tube so the front (open) end is pointing in the general direction of an object at least 1/4-mile away. With your fingers, slowly rotate one of the focus wheels until the object comes into sharp focus. Go a little bit beyond sharp focus until the image starts to blur again, then reverse the rotation of the knob, just to make sure you've hit the exact focus point.

Operating the EZ Finder II Reflex Sight

The EZ Finder II reflex sight (**Figure 18**) works by projecting a tiny red dot onto a lens mounted in the front of the unit. When you look through the EZ Finder II, the red dot will appear to float in space, helping you locate even the faintest of deep space objects. The red dot is produced by a light-emitting diode (LED), not a laser beam, near the rear of the sight. A replaceable 3-volt lithium battery provides the power for the diode.

To use the EZ Finder II, turn the power knob clockwise until you hear a "click" indicating power has been turned on. With your eye positioned at a comfortable distance, look through the back of the reflex sight with both eyes open to see the red dot. The intensity of the dot can be adjusted by turning the power knob. For best results when stargazing, use the dimmest possible setting that allows you to see the dot without difficulty. Typically, a dim setting is used under dark skies and a bright setting is used under light-polluted skies or in daylight.

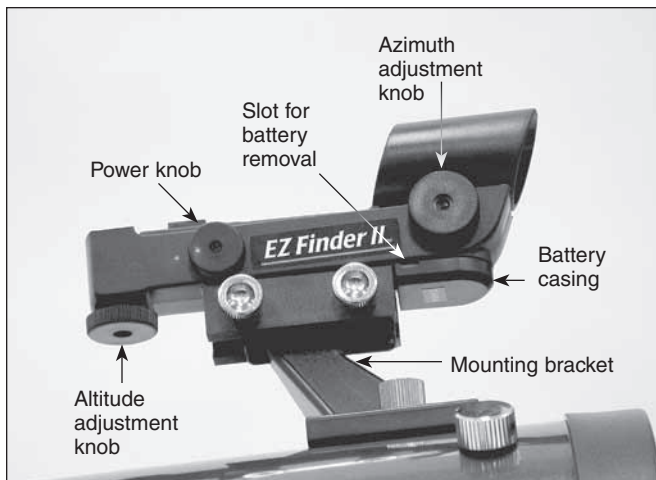

Figure 18. The EZ Finder II reflex sight. If it is present, remove the thin plastic battery shield (not shown) from the battery casing prior to use and discard it.

At the end of your observing session, be sure to turn the power knob counterclockwise until it clicks off. When the two white dots on the EZ Finder II's rail and power knob are lined up, the EZ Finder II is turned off.

Aligning the EZ Finder II

When the EZ Finder II is properly aligned with the telescope, an object that is centered on the EZ Finder II's red dot should also appear in the center of the field of view of the telescope's eyepiece. Alignment of the EZ Finder II is easiest to do during daylight, before observing at night. Aim the telescope at a distant object at least 1/4 mile away, such as a telephone pole or chimney and center it in the telescope's eyepiece. Now, turn the EZ Finder II on and look through it. The object will appear in the field of view near the red dot.

Note: The image in the eyepiece of the StarBlast 6/6i will not be oriented right-side-up, but rather will be upside-down or rotated somewhat from a correctly oriented, naked-eye view. This is normal for Newtonian reflector telescopes.

Without moving the telescope, use the EZ Finder II's azimuth (left/right) and altitude (up/down) adjustment knobs (**Figure 18**) to position the red dot on the object in the eyepiece.

When the red dot is centered on the distant object, check to make sure the object is still centered in the telescope's field of view. If not, recenter it and adjust the EZ Finder II's alignment again. When the object is centered in the eyepiece and on the red dot, the EZ Finder II is properly aligned with the telescope. **Figure 19** simulates the view through the EZ Finder II.

Once aligned, the EZ Finder II will usually hold its alignment even after being removed and remounted. Otherwise, only minimal realignment will be needed.

Replacing the EZ Finder II Battery

Replacement 3-volt lithium batteries for the EZ Finder II are available from many retail outlets. Remove the old battery by inserting a small flat-head screwdriver into the slot on the battery casing (**Figure 18**) and gently prying open the case. Then



Figure 19. The EZ Finder II superimposes a tiny red dot on the sky, showing right where the telescope is aimed.

carefully pull back on the retaining clip and remove the old battery. Do not over-bend the retaining clip. Slide the new battery under the battery lead with the positive (+) side facing down and replace the battery casing.

7. Observing With Your Telescope

This section applies to both the StarBlast 6 (#10016) and StarBlast 6i IntelliScope (#27191). Specific instructions on how to use the IntelliScope Computerized Object Locator with the StarBlast 6i IntelliScope are provided in the section entitled "Using the IntelliScope Computerized Object Locator."

Choosing an Observing Site

When selecting a location for observing, get as far away as possible from direct artificial light such as street lights, porch lights, and automobile headlights. The glare from these lights will greatly impair your dark-adapted night vision. Avoid viewing over rooftops and chimneys, as they often have warm air currents rising from them. Similarly, avoid observing from indoors through an open (or closed) window, because the temperature difference between the indoor and outdoor air will cause image blurring and distortion.

If at all possible, escape the light-polluted city sky and head for darker country skies. You'll be amazed at how many more stars and deep-sky objects are visible in a dark sky!

"Seeing" and Transparency

Atmospheric conditions vary significantly from night to night. "Seeing" refers to the steadiness of the Earth's atmosphere at a given time. In conditions of poor seeing, atmospheric turbulence causes objects viewed through the telescope to "boil." If, when you look up at the sky with your naked eyes, the stars are twinkling noticeably, the seeing is bad and you will be limited to viewing with low powers. This is because bad

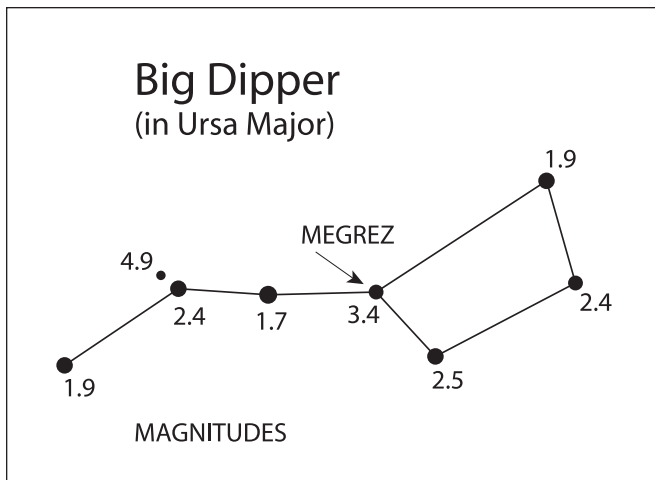

Figure 20. Megrez connects the Big Dipper’s “handle” to its “pan.” If you cannot see Megrez, a magnitude 3.4 star, then the viewing conditions are poor.

seeing affects images at high powers more severely. Planetary observing may also be poor.

In conditions of good seeing, star twinkling is minimal and images appear steady in the eyepiece. Seeing is best overhead, worst at the horizon. Also, seeing generally gets better after midnight, when much of the heat absorbed by the Earth during the day has radiated off into space.

Especially important for observing faint objects is good “transparency” – air free of moisture, smoke, and dust. All tend to scatter light, which reduces an object’s brightness. Transparency is judged by the magnitude of the faintest stars you can see with the unaided eye (6th magnitude or fainter is desirable).

If you cannot see stars of magnitude 3.5 or dimmer, then conditions are poor. Magnitude is a measure of how bright a star is: the brighter the star, the lower its magnitude. A good star to remember for this is Megrez (mag. 3.4), which is the star in the “Big Dipper” that connects the “handle” to the “pan” of the dipper (**Figure 20**). If you cannot see Megrez, then you have fog, haze, clouds, smog, or other conditions (such as light pollution) that are hindering your viewing.

Tracking Celestial Objects

The Earth is constantly rotating about its polar axis, completing one full rotation every 24 hours; this is what defines a “day.” We do not feel the Earth rotating, but we see it at night from the apparent movement of stars from east to west.

When you observe any astronomical object, you are in essence watching a moving target. This means the telescope’s position must be continuously adjusted over time to keep the object in the field of view. This is easy to do with the StarBlast 6/6i because of its smooth motions on both axes. As the object moves off towards the edge of the field of view, just lightly nudge the telescope to re-center it.

Objects appear to move across the field of view faster at higher magnifications. This is because the field of view becomes narrower.

Eyepiece Selection

By using eyepieces of different focal lengths, it is possible to attain many magnifications, or powers, with the StarBlast 6/6i. Your telescope comes with two Sirius Plössl eyepieces of different focal lengths: a 25mm, which provides a magnification of 30x, and a 10mm, which yields 75x. Other eyepieces can be used to achieve higher or lower powers. It is quite common for an observer to own many eyepieces to access a wide range of magnifications.

To calculate the magnification of a telescope-eyepiece combination, simply divide the focal length of the telescope by the focal length of the eyepiece.

$$\frac{\text{Telescope Focal Length (mm)}}{\text{Eyepiece Focal Length (mm)}} = \text{Magnification}$$

For example, the StarBlast 6, which has a focal length of 750mm, used in combination with the 25mm eyepiece, yields a magnification of

$$\frac{750\text{mm}}{25\text{mm}} = 30\text{x}$$

Whatever you choose to view, always start by inserting your lowest-power (longest focal length) eyepiece to locate and center the object. Low magnification yields a wide field of view, which shows a larger area of sky in the eyepiece. This makes finding and centering an object much easier. Trying to find and center objects with a high-power (narrow field of view) eyepiece is like trying to find a needle in a haystack!

Once you’ve centered the object in the eyepiece, you can switch to a higher magnification (shorter focal length) eyepiece, if you wish. This is recommended for small and bright objects, like planets and double stars. The Moon also takes higher magnifications well.

The best rule of thumb with eyepiece selection is to start with a low-power, wide-field eyepiece, and then work your way up in magnification. If the object looks better, try an even higher magnification eyepiece. If the object looks worse, then back off the magnification a little by using a lower-power eyepiece.

What to Expect

So what will you see with your telescope? You should be able to see bands on Jupiter, the rings of Saturn, craters on the Moon, phases of Venus, and many bright deep-sky objects. Do not expect to see color as you do in NASA photos, since those are taken with long-exposure cameras and have “false color” added. Our eyes are not sensitive enough to see color in faint deep-sky objects, except in a few of the brightest ones.

Remember that you are seeing these objects with your own eyes in real time, using your own telescope! That beats looking at a picture in a book or on a computer screen, in our opinion. Each session with your telescope will be a learning experience. Each time you work with your telescope it will get easier to use, and celestial objects will become easier to find. There is a big difference between looking at a well-made, full-color NASA image of a deep-sky object in a lit room during the daytime, and seeing that same object in your telescope at night.

Magnification Limits

Every telescope has a useful magnification limit of about 2X per millimeter of aperture. This comes to 300X for the StarBlast 6. Some telescope manufacturers will use misleading claims of excess magnification, such as “See distant galaxies at 640X!”. While such magnifications are technically possible, the actual image at that magnification would be an indistinct blur.

Moderate magnifications are what give the best views. It is better to view a small, but bright and detailed image than a dim, unclear, oversized image.

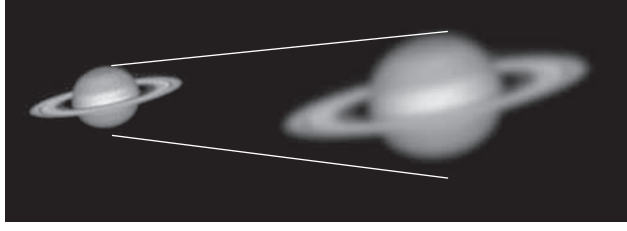

One can merely be a pretty image someone gave to you. The other is an experience you will never forget!

Objects to Observe

Now that you are all set up and ready to go, one critical decision must be made: what to look at?

A. The Moon

With its rocky surface, the Moon is one of the easiest and most interesting targets to view with your telescope. Lunar craters, maria, and even mountain ranges can all be clearly seen from a distance of 238,000 miles away! With its ever-changing phases, you'll get a new view of the Moon every night. The best time to observe our one and only natural satellite is during a partial phase, that is, when the Moon is NOT full. During partial phases, shadows are cast on the surface, which reveal more detail, especially right along the border between the dark and light portions of the disk (called the “terminator”). A full Moon is too bright and devoid of surface shadows to yield a pleasing view. Make sure to observe the Moon when it is well above the horizon to get the sharpest images.

Use an optional Moon filter to dim the Moon when it is very bright. It simply threads onto the bottom of the eyepiece barrels (you must first remove the eyepiece from the focuser to attach a filter). You'll find that the Moon filter improves viewing comfort, and also helps to bring out subtle features on the lunar surface.

B. The Sun

You can change your nighttime telescope into a daytime Sun viewer by installing an optional full-aperture solar filter over the front opening of the StarBlast 6/6i. The primary attraction is sunspots, which change shape, appearance, and location daily. Sunspots are directly related to magnetic activity in the Sun. Many observers like to make drawings of sunspots to monitor how the Sun is changing from day to day.

Important Note: Do not look at the Sun with any optical instrument without a professionally made solar filter, or permanent eye damage could result.

C. The Planets

The planets don't stay put like the stars, so to find them you should refer to “This Month's Sky Summary” in the Learning Center section of our website (telescope.com). Venus, Jupiter, and Saturn are the brightest objects in the sky after the Sun and the Moon. Your StarBlast 6/6i is capable of showing you these planets in some detail. Other planets may be visible but will likely appear star-like. Because planets are quite small in apparent size, optional higher-power eyepieces are recommended and often needed for detailed observations. Not all the planets are generally visible at any one time.

JUPITER: The largest planet, Jupiter, is a great subject for observation. You can see cloud bands on the disk of the giant planet and watch the ever-changing positions of its four largest moons: Io, Callisto, Europa, and Ganymede.

SATURN: The ringed planet is a breathtaking sight when it is well positioned. The tilt angle of the rings varies over a period of many years; sometimes they are seen edge-on, while at other times they are broadside and look like giant “ears” on each side of Saturn's disk. A steady atmosphere (good seeing) is necessary for a good view. You will probably see a bright “star” close by, which is Saturn's brightest moon, Titan.

VENUS: At its brightest, Venus is the most luminous object in the sky, excluding the Sun and the Moon. It is so bright that sometimes it is visible to the naked eye during full daylight! Ironically, Venus appears as a thin crescent, not a full disk, when at its peak brightness. Because it is so close to the Sun, it never wanders too far from the morning or evening horizon. No surface markings can be seen on Venus, which is always shrouded in dense clouds.

D. The Stars

Stars will appear like twinkling points of light. Even powerful telescopes cannot magnify stars to appear as more than a point of light. You can, however, enjoy the different colors of the stars and locate many pretty double and multiple stars. The gorgeous two-color double star Albireo in Cygnus is a favorite. Defocusing a star slightly can help bring out its color.

E. Deep-Sky Objects

Under dark skies, you can observe a wealth of fascinating deep-sky objects, including gaseous nebulas, open and globular star clusters, and a variety of different types of galaxies. Most deep-sky objects are very faint, so it is important to find an observing site well away from light pollution. Take plenty of time to let your eyes adjust to the darkness. Do not expect these subjects to appear like the photographs you see in books and magazines; most will look like dim gray smudges. Our eyes are not sensitive enough to see color in deep-sky objects except in a few of the brightest ones. But as you become more experienced and your observing skills get sharper, you will be able to discern more and more subtle details and structure.

To find deep-sky objects in the sky, it is best to consult astronomy software, or a star chart or planisphere. These guides

will help you locate the brightest and best deep-sky objects for viewing with your StarBlast 6/6i. Of course, if you purchased the StarBlast 6i IntelliScope, you will be able to easily locate dozens of deep-sky objects in a given evening with the IntelliScope Computerized Locator!

You can also try low-power scanning of the Milky Way. Use the 25mm eyepiece and just cruise through the “star clouds” of our galaxy. You’ll be amazed at the rich fields of stars and objects you’ll see! The Milky Way is best observed on summer and winter evenings.

8. Using the IntelliScope Computerized Object Locator

This section applies only to the StarBlast 6i IntelliScope (#27191), which comes with the Computerized Object Locator.

The IntelliScope Computerized Object Locator (controller) (**Figure 21**) will provide quick, easy access to thousands of celestial objects for viewing with your telescope.

The controller’s user-friendly keypad combined with its database of more than 14,000 celestial objects put the night sky literally at your fingertips. You just select an object to view, press Enter, then move the telescope manually following the guide arrows on the liquid crystal display (LCD) screen. In seconds, the IntelliScope’s high-resolution, 9,216-step digital encoders pinpoint the object, placing it smack-dab in the telescope’s field of view!

A. Alignment

This section will familiarize you with the alignment procedure for the IntelliScope system.

Powering the Controller

Install the included 9-volt alkaline battery in the battery compartment on the back of the controller. Make sure the positive and negative terminals are oriented as indicated by the labels next to the terminals in the battery compartment. To turn the controller on, firmly press the Power button. The LED lights will activate and the LCD screen will display its introduction message. The intensity of the illumination can be adjusted by repeatedly pressing the Power button. There are five levels of LED brightness. Choose a brightness level that suits your conditions and needs. (Dimmer settings will prolong battery life.)

To turn the controller off, press and hold the Power button for a few seconds, then release it.

To conserve battery life, the controller is programmed to shut itself off after being idle for 50 minutes. So, make sure to press a button at least once every 50 minutes if you do not want the controller to turn off. If the controller does turn off, you will need to perform the initial alignment procedure again.

If the LCD screen and the buttons’ backlighting automatically begin to dim, it’s time to change batteries.

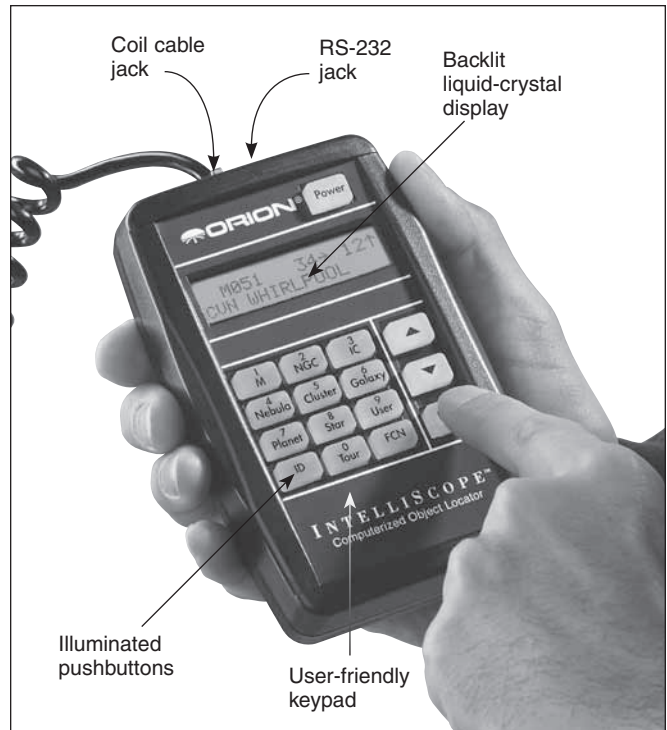

Figure 21. The IntelliScope Computerized Object Locator

Initial Vertical Alignment

After powering up the controller, the top line of the LCD display will read: “POINT VERTICAL.” If the top line reads “ALIGN DEC MARK,” simply press the up arrow button. The top line will now read “POINT VERTICAL,” and you are set to use the object locator with your IntelliScope Dobsonian.

If the vertical stop you installed on the top baseplate during assembly of the telescope is properly adjusted (see below), rotate the optical tube upward until the rear end ring comes in contact with the vertical stop knob, as shown in **Figure 22**. You may have to raise or lower the tube in the tube rings to achieve contact between the flat portion of the rear end ring and the vertical stop knob. Once the optical tube is in the vertical position, press the Enter button to start the two-star alignment procedure.

Setting the Vertical Stop

For the IntelliScope system to work accurately, the vertical stop must be precisely set so that the optical tube is truly perpendicular to the azimuth axis of the base when the controller says “POINT VERTICAL.” For this you will need a carpenter’s level, which you can find at just about any hardware store.

First, make sure the base itself is level. Place the carpenter’s level on the top baseplate and rotate the base 180° in azimuth (**Figure 23**). The level should indicate that the base is level through the entire rotation. If not, then reposition the base on the ground, or place shims underneath the feet until the base stays level though a 180° rotation.

Next, rotate the optical tube upward until the rear end ring comes in contact with the vertical stop knob. Place the carpenter’s level across the top of the optical tube (**Figure 24**). Is

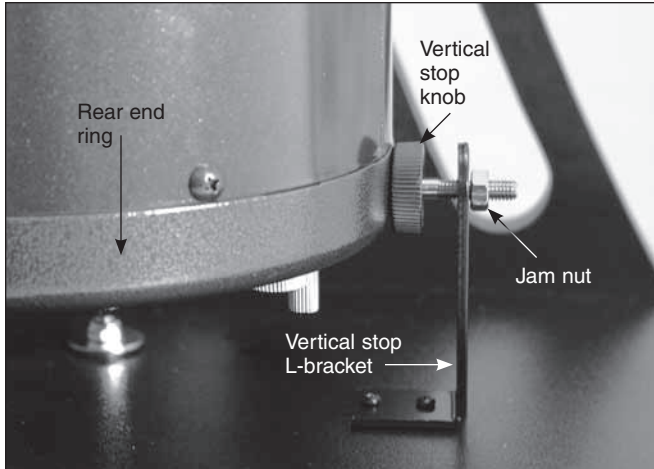

Figure 22. Once the vertical stop is adjusted and set initially, pointing the optical tube vertically is as easy as rotating the tube until the bottom end ring contacts the vertical stop knob, as shown. Make sure the middle of the end ring – not the rounded bottom edge – contacts the vertical stop knob.

it level? If so, thread the jam nut tight against the back of the L-bracket to secure the vertical stop knob in that exact position. If the top of the optical tube is not level, thread the vertical stop bolt in or out as needed until the top of the tube is level when the end ring comes in contact with the vertical stop knob. Then secure the vertical stop bolt in place with the jam nut.

Once the vertical stop bolt is accurately adjusted, it should not need adjustment again. The base does not need to be level for the IntelliScope system to function properly; the base only needs leveling when initially setting the vertical stop.

Simple Two-Star Alignment

After setting the vertical position of the optical tube, a simple two-star alignment process is all that is needed to ready the IntelliScope system for operation. This is a great simplification from many other computerized systems, which require you to enter data such as your longitude, latitude, and time zone. For the IntelliScope controller to accurately find objects, you only need to center two bright stars in your telescope and indicate to the controller which two stars you have centered. This is quite easy to do. For your convenience, we have provided finder charts for the alignment stars in Appendix D. Use the finder chart to locate and identify two bright stars in your current night sky. For best results, choose two stars that are at least 60° apart from each other. (The width of your fist at arm's length is about 10°, so you want the stars to be at least six fist-widths apart.)

So, the optical tube is now in the vertical position and you've chosen two bright stars in the sky to use for alignment. The telescope should have a high-power eyepiece, such as the 10mm Sirius Plössl, in the eyepiece holder and the finder scope should be properly aligned with the telescope (these procedures are described elsewhere in this manual). The LCD screen will state on its top line "ALIGN STAR 1," with the name of a star flashing on the second line.



Figure 23. Place a carpenter's level on the altazimuth base as shown. Add shims under the three feet as needed so that the base stays level through a 180-degree rotation in azimuth. Once the vertical stop is set, the base does not need to be level to function properly.



Figure 24. Once the base is leveled, point the optical tube up until the mirror cell (bottom end ring) contacts the vertical stop knob. Then place the carpenter's level across the top of the tube as shown and adjust the vertical stop knob until the tube is level. After each adjustment of the vertical stop knob, make sure to re-establish contact between the telescope end ring and the knob before checking the carpenter's level.

Use the arrow buttons to scroll through the names of the alignment stars. The up arrow button scrolls through the stars alphabetically from A to Z. The down arrow button scrolls alphabetically backwards, from Z to A. When you arrive at the name of the star you wish to align on, you can begin to move the telescope so that it is pointing at that star (but don't press the Enter button yet).

Note: The controller will not accept Polaris as the first alignment star. This helps prevent the pointing accuracy from decreasing over time. It is OK to use Polaris as the second alignment star, however.

Take hold of the “navigation knob” on the optical tube and move the telescope so that it is pointing in the general area of the alignment star. Aim the telescope so the alignment star appears in finder scope. Be careful not to confuse the alignment star with other stars in the area when doing this. (It will likely be the brightest star in the field of view.) Now, move the telescope until you have centered the star on the crosshairs of the finder scope. Look into the eyepiece of the telescope, and you should see the alignment star in the field of view of the eyepiece. If it isn't, then your finder scope is out of alignment with your telescope and will need to be adjusted. Once the alignment star is in the eyepiece's field of view, center it in the eyepiece as best you can by making small movements to the telescope. (If you have one, an illuminated reticle eyepiece is great for centering alignment stars). Once this is done, press the Enter button on the controller. You have now completed one-half of the two-star alignment.

The LCD screen will now read “ALIGN STAR 2” on the first line with an alignment star's name flashing on the second line. As before, scroll through the names of the stars with the arrow buttons until you reach your second chosen alignment star. Repeat the procedure described above for your second alignment star. When you have aligned on the second star, press the Enter button. The LCD will then display a number. It is the alignment error factor, or “warp” (W) factor.

The Alignment Error (Warp) Factor

The “warp” alignment error factor essentially lets you know if your alignment was accurate or not. Ideally, this number should be as low as possible, but any “W” of 0.5 or smaller is acceptable (regardless of + or - sign). Warp factors of ± 0.3 and ± 0.4 are the most common. Warp factors under ± 0.2 are typically not achievable (but kudos to you if you get one!). If you complete an alignment and the warp factor is larger than ± 0.5 (e.g., +0.6, -0.6, +0.7, -0.7, etc.), then you must turn the controller off (by holding down the Power button) and begin the alignment procedure again. Otherwise, there is no guarantee that the controller will consistently place objects within the field of view of a medium-low power eyepiece.

An unacceptable warp factor may indicate that you aligned on the wrong star or did not have the telescope initially in a precisely vertical position. If you are having problems getting the warp factor at or below ± 0.5 , see the troubleshooting section in Appendix C.

Your IntelliScope Computerized Object Locator is now ready to find objects. Replace the high-powered eyepiece you used



Figure 25. If you're positioned to the left of the telescope and face the direction the optical tube is pointed, the guide arrows on the Computerized Object Locator will correspond exactly with the direction you should move the telescope to pinpoint the selected object.

for centering the alignment stars with a low-power, wide-field eyepiece, such as the 25mm Sirius Plössl.

B. Overview of the IntelliScope Computerized Object Locator

The IntelliScope Computerized Object Locator (controller) has been specifically designed for ease of use. This section will help familiarize you with the basic layout and operation of the controller.

Pushbuttons

Besides the Power, Enter, ID, FCN, and up/down arrows, all pushbuttons have letters on them with numbers above them (**Figure 21**). The letters designate the function of the pushbutton. The numbers above them are used for entering numerical data only; the numbers are never active until a function is first chosen. The numbers are arranged like a telephone keypad for ease of number entry. None of the function buttons will work properly until an initial alignment, as outlined previously, is completed. If you press a function button before the two-star alignment is completed, the controller will display “MUST STAR ALIGN.” Turn the unit off, then on again (by using the Power button), to begin the alignment routine again.



Figure 26. This sequence of pictures illustrate how the Computerized Object Locator's guide arrows look as you are finding a celestial object. **(a)** When the optical tube is aimed far away from the object's location, there will be a number (from 10 to 179) to the left of the guide arrows. **(b)** When the scope is aimed close to the object, each guide arrow will display a number on its immediate left (from 0 to 9) and immediate right (from 0 to 9); the number on the left is whole number increments, while the number on the right is in increments of tenths. This helps in making small movements to the telescope to pinpoint the object's location. **(c)** When the guide arrows display "0.0 0.0", the object will be within the field of view of the telescope (with a 25mm or longer focal length eyepiece).

The Guide Arrows

The controller leads you to astronomical targets with guide arrows displayed on the LCD screen. After an object is selected to view, you will see two guide arrows, one that points left or right, and one that points up or down. Move the telescope tube in the corresponding direction of the guide arrows. If you are standing to the left of the telescope and facing the same direction the telescope is pointed, the guide arrows will exactly correspond with the direction you should move the telescope (**Figure 25**). Otherwise, if an up arrow is displayed, move the telescope tube upward, if a down arrow is displayed, move the telescope tube downward, if a left arrow is displayed, rotate the telescope counterclockwise, and if a right arrow is displayed, rotate the telescope clockwise. There is a number next to each guide arrow that indicates how far the telescope needs to be moved to reach the selected object. As you move the telescope toward the object, this number will decrease. When the number goes below ten, the figure will be displayed in tenths; this helps to make small, precise movements to the telescope tube in order to bring the object into your field of view. When both numbers reach zero, stop moving the telescope. The object will be within the field of view of a medium- to low-power eyepiece (25mm focal length or longer).

For example, look at **Figure 26a**, which shows the LCD screen for someone trying to locate M51, otherwise known as the Whirlpool Galaxy. The first arrow is pointing right and gives a number of 34. The second arrow is pointing up and displays the number 12. This means that the telescope tube should be moved to the right (clockwise) and up. When you are close to

M51, the numbers will be displayed in tenths, as is shown in **Figure 26b**. When the numbers reach zero (**Figure 26c**), the telescope will be pointed right at the Whirlpool Galaxy.

It is easiest to move the telescope in one direction at a time (say altitude) until the corresponding number reached "0.0". Then move the scope in the other direction (azimuth) until that number also reads "0.0".

If the object selected to view is currently located below the horizon, the word "HORIZON" will flash before the guide arrows are displayed. Choose another object to view.

C. Locating the Planets

By far the most popular objects for viewing, after the Moon, are the planets. Since the other eight planets in our solar system are also orbiting the Sun, they do not appear in fixed positions in the night sky like deep-sky objects and stars do. Because of this, the controller requires you to input the date before it can find the planets.

To find planets with your IntelliScope Computerized Object Locator, use the following procedure:

1. Press the Planet button on the controller.
2. The LCD screen will display a date similar to the following:
3. The number after the word "DATE" will be flashing and represents the day of the month. Input the two-digit day using the number buttons.
4. The three-letter month will now be flashing. Use the arrow buttons to scroll to the present month and then press the Enter button.
5. Now the year will flash. Input the year using the number buttons.

If you make a mistake while inputting the date, press the Enter button at any time while still within the Planet button function. The LCD screen will then display the last date input, with the two-digit day after the word "DATE" flashing. Input the correct date as outlined above.

Now, to choose a planet to view, press the arrow buttons and scroll through the planets. The planet's name will be displayed in the upper left section of the LCD screen, with the guide arrows on the upper right of the LCD screen. Move the telescope in the corresponding direction shown by the guide arrows.

The lower left screen shows the constellation that the planet appears in, with its present co-ordinates given in right ascension and declination. When you are finished viewing the planet, you may scroll to another planet by using the arrow buttons.

The features and details you can see will vary from planet to planet. The following descriptions give a brief overview of what to expect when viewing them:

MERCURY Mercury is often so close to the Sun that it cannot be seen. Sometimes it is visible for a brief period after the Sun sets, and sometimes it's visible in the morning just before the Sun rises. Mercury does not really show any detail, but is quite bright. With your telescope, you will be able to investigate this

planet's orange-colored hue. Like Venus, Mercury sometimes appears as a crescent, rather than as a full disk.

VENUS At its brightest, Venus is the most luminous object in the sky, excluding the Sun and the Moon. It is so bright that sometimes it is visible to the naked eye during full daylight! Ironically, Venus appears as a thin crescent, not a full disk, when at its peak brightness. Because it is close to the Sun, it never wanders too far from the morning or evening horizon. No surface markings can be seen on Venus, which is always shrouded in dense clouds.

MARS The Red Planet makes its closest approach to Earth every two years. During close approaches you'll see a red disk, possibly some light and dark regions, and maybe the polar ice cap. To see surface detail on Mars, you will need a high power eyepiece and very steady air!

JUPITER The largest planet, Jupiter, is a great subject for observation. You can see the disk of the giant planet and watch the ever-changing positions of its four largest moons – Io, Callisto, Europa, and Ganymede. Higher power eyepieces should bring out the cloud bands on the planet's disk and maybe even the Great Red Spot.

SATURN The ringed planet is a breathtaking sight when it is well positioned. The tilt angle of the rings varies over a period of many years; sometimes they are seen edge-on, while at other times they are broadside and look like giant "ears" on each side of Saturn's disk. A steady atmosphere (good seeing) is necessary for a good view. You will probably see a bright "star" close by, which is Saturn's brightest moon, Titan.

URANUS Uranus is a faint planet, and requires high powers (at least 100x) before it starts to show any detail that distinguishes it from stars. Uranus will appear as a pale, blue-green disk.

NEPTUNE Like Uranus, Neptune will require high powers before showing anything to distinguish itself from stars. Neptune will appear as a bluish-colored disk, possibly with a very faint moon nearby if you are using a larger-aperture IntelliScope.

PLUTO Smaller than our own Moon, Pluto is very, very faint and shows little more than a point of light similar to a star. Even the Hubble Space Telescope is unable to show much detail on Pluto. Many amateur astronomers note how Pluto moves with respect to background stars (over several nights) in order to confirm their observation of our most remote planet.

D. Locating Deep-Sky Objects by Catalog

Catalogs are groups of deep sky objects of interest that have been assembled and given designations. Very often a deep-sky object will have a catalog number, as well as a "common" name. For example, the Orion Nebula is listed in the Messier catalog as "M42." The controller has three catalogs built-in: The Messier catalog (M), the New General Catalog (NGC), and the Index Catalog (IC). Many of the objects in the Messier catalog also have NGC catalog designations.

The Messier Catalog

The Messier catalog contains 110 galaxies, nebulas, and star clusters identified by the famous French astronomer Charles

Messier and his colleagues in the late 1700's. These are some of the most popular celestial attractions observed by amateur astronomers.

To view an object from the Messier catalog, press the M button. Then enter the number of the Messier object you wish to view using the numeric buttons and press the Enter button. For example, to view Messier 57, also known as "the Ring Nebula," you would press the M button, then press the "5" button, then press the "7" button, followed by the Enter button. If the number of the Messier object you wish to view contains three digits, it is not necessary to press Enter after inputting the third digit.

The object's catalog designation will be shown in the upper left corner of the display screen, with the guide arrows in the upper right. The lower left will display the constellation the object resides in and the object's common name (if it has one) or a brief description of the object. Move the telescope in the corresponding directions shown by the guide arrows to locate the object.

You can get more information about the selected object by pressing the Enter button. The second line of the LCD display will then cycle information about the object you are viewing such as its celestial coordinates (R.A. and Dec.), magnitude (brightness), size (in arc-minutes or arc-seconds), and a brief scrolling text description.

When you are finished viewing the selected Messier object, you may scroll to another Messier object by using the arrow buttons, or you can select another Messier object to view by pressing the M button again.

The New General Catalog

The New General Catalog, or NGC, is a catalog of some 7,840 deep-sky objects compiled by the Danish astronomer J. L. E. Dreyer more than 100 years ago. It contains hundreds of excellent examples of each type of deep-sky object and is the most well known and used catalog by amateur astronomers beyond the already mentioned Messier catalog. To be more precise, the version of the New General Catalog used in the IntelliScope Computerized Object Locator is an improved version known as the "Revised New General Catalog"; this version has many corrections from Dreyer's original list.

To view an object from the NGC catalog, press the NGC button. Then enter the number of the NGC object you wish to view using the numeric buttons and press Enter. For example, to view the Andromeda Galaxy, which is listed as NGC224, you would press the NGC button, then the "2" button twice, then the "4" button, followed by the Enter button. If the number of the NGC object you wish to view contains four digits, it is not necessary to press Enter after inputting the fourth digit.

The object's catalog designation will be shown in the upper left corner of the LCD screen, with the guide arrows in the upper right. The lower left will show the constellation the object resides in, and the object's common name (if it has one) or a brief description of the object will be shown in the lower right. Move the telescope in the corresponding directions shown by the guide arrows.

You can get more information about the selected object by pressing the Enter button. The second line of the LCD display

will then cycle information about the object you are viewing such as its celestial coordinates (R.A. and Dec.), magnitude (brightness), size (in arc-minutes or arc-seconds), and a brief scrolling text description.

When you are finished viewing the selected NGC object, you may scroll to another NGC object by using the arrow buttons, or you can select another NGC object to view by pressing the NGC button again.

The Index Catalog

The Index Catalog, or IC, contains 5,386 objects discovered in the decade or so after the NGC catalog was first published. This list contains objects similar to the NGC, but IC objects are typically fainter and more difficult to observe.

To view an object from the IC catalog, press the IC button. Then input the number of the IC object you wish to view using the numeric buttons and press the Enter button. For example, to view the Flaming Star Nebula, which is listed as IC405, you would press the IC button, then the “4” button, then the “0” button, then the “5” button, followed by the Enter button. If the number of the IC object you wish to view contains four digits, it is not necessary to press Enter after inputting the fourth digit.

The object’s catalog designation will be shown in the upper left corner of the LCD screen, with the guide arrows in the upper right. The lower left will show the constellation the object resides in, and the object’s common name (if it has one) or a brief description of the object will be shown in the lower right. Move the telescope in the corresponding directions shown by the guide arrows.

You can get more information about the selected object by pressing the Enter button. The second line of the LCD display will then cycle information about the object you are viewing such as its celestial coordinates (R.A. and Dec.), magnitude (brightness), size (in arc-minutes or arc-seconds), and a brief scrolling text description.

When you are finished viewing the selected IC object, you may scroll to another IC object by using the arrow buttons, or you can select another IC object to view by pressing the IC button again.

E. Locating Deep Sky Objects by Object Type

Rather than trying to select objects by catalog numbers, you may wish to simply view certain types of objects. This is where the Nebula, Galaxy, and Cluster buttons come in handy. These buttons will access a selection of the best and brightest nebulas, galaxies, and star clusters in the night sky.

The Nebula, Cluster and Galaxy buttons are organized by constellation. So, before using these buttons, decide in which constellation you would like to view an object. Choose a constellation that is at least 40° high in the sky to get a good view. If you are unsure of the constellations currently visible in your night sky, consult a planisphere or the monthly star chart at www.orient telescopes.com.

Locating Nebulas

Amongst the most beautiful objects in the night sky, nebulas are clouds of dust and gas that are lit by a nearby stellar source. There are several different types of nebulas; emission

nebulas, which are where star systems form, planetary nebulas, which are the result of a star dying, and reflection nebulas, which are caused by dust reflecting starlight. Most have low surface brightness, so a dark sky free of light-pollution is best for a night of viewing nebulas.

To view a nebula, press the Nebula button on the controller. The LCD screen will then display the word “NEBULA” with a flashing three-letter constellation designation after it. Now, select the constellation in which you would like to view a nebula. Use the arrow buttons to scroll through the list of constellations. If you are unsure which constellation the three-letter designation represents, refer to Appendix E. Once you have selected the constellation, press Enter. A nebula in that constellation will now appear on the LCD screen, along with the guide arrows to lead you to the nebula. The current constellation is shown in the lower left, and the nebula’s proper name or catalog number is in the lower right. For more information about the nebula selected, press the Enter button.

To go to the next nebula in the selected constellation, simply press the up arrow button. The guide arrows will now direct you to the next nebula in the constellation. If there are no more nebulas available in that constellation, a nebula from the next constellation (in alphabetical order) will be displayed. To select another constellation in which to view nebulas, press the Nebula button again.

Locating Star Clusters

Star clusters are just what their name implies; groupings of stars. Star clusters come in two main types, open and globular. Open star clusters reside within our Milky Way galaxy and usually contain a handful of stars clustered together because they were spawned from the same gas cloud. Globular clusters are more like miniature galaxies, with hundreds or thousands of stars packed into a spherical shape by mutual gravity. Globular clusters reside outside the disk of the Milky Way galaxy and orbit the galaxy’s center. It is believed that globular clusters are formed as a natural consequence of galaxy formation. Star clusters, in general, are somewhat bright compared to other deep-sky objects, so many will appear quite spectacular, even in smaller telescopes.

To view a star cluster, press the Cluster button on the controller. The LCD screen will then display the word “STAR CLUSTER” with a flashing three-letter constellation designation after it. Now, select the constellation in which you would like to view a star cluster. Use the arrow buttons to scroll through the list of constellations. If you are unsure which constellation the three-letter designation represents, refer to Appendix E. Once you have selected the constellation, press Enter. A star cluster in that constellation will now appear on the LCD screen, along with the guide arrows to lead you to the star cluster. The current constellation is shown in the lower left, and the star cluster’s proper name or catalog number is in the lower right. For more information about the star cluster selected, press the Enter button.

To go to the next star cluster in the selected constellation, simply press the up arrow button. The guide arrows will now direct you to the next star cluster in the constellation. If there are no more star clusters available in that constellation, a star cluster

from the next constellation (in alphabetical order) will be displayed. To select another constellation in which to view a star cluster, press the Cluster button again.

Locating Galaxies

Nebulas may be beautiful and star clusters impressive, but nothing has quite the breathtaking power of observing a galaxy. Galaxies are collections of billions of stars that come in a variety of shapes and sizes. Viewing a galaxy always gives the observer a revelation of just how vast our universe truly is. Keep in mind, however, that most galaxies are quite faint, and may be challenging to identify, especially in smaller telescopes.

To view a galaxy, press the Galaxy button on the controller. The LCD screen will then display the word "GALAXY" with a flashing three-letter constellation designation after it. Now, select the constellation in which you would like to view a galaxy. Use the arrow buttons to scroll through the list of constellations. If you are unsure which constellation the three-letter designation represents, refer to Appendix E. Once you have selected the constellation, press Enter. A galaxy in that constellation will now appear on the LCD screen, along with the guide arrows to lead you to the galaxy. The current constellation is shown in the lower left, and the galaxy's proper name or catalog number is in the lower right. If you wish to have more information about the galaxy selected, press the Enter button.

To go to the next galaxy in the selected constellation, simply press the up arrow button. The guide arrows will now direct you to the next galaxy in the constellation. If there are no more galaxies available in that constellation, a galaxy from the next constellation (in alphabetical order) will be displayed. To select another constellation in which to view galaxy, press the Galaxy button again.

F. Locating Stars

The IntelliScope database contains 837 stars. Stars always appear like tiny points of light. Even powerful telescopes cannot magnify a star to appear as more than a point of light! You can, however, enjoy the different colors of the stars and locate many pretty double and multiple stars. You can also monitor variable stars from night to night to see how their brightness changes over time.

To view a star, press the Star button on the controller. The LCD screen will then display the word "STAR" with the word "NAMED" flashing next to it. From this screen, use the arrow buttons to choose from "NAMED," "DOUBLE," "VARIABLE," and "CATALOG."

Named Stars

The named stars are the brightest in the night sky. These are the stars that the ancients gave proper names to, like "Arcturus" or "Mizar."

To select a named star, press Enter after selecting "NAMED" from the Star button choices. You can now use the arrow buttons to scroll through the list of named stars. The stars are listed in alphabetical order. Once you have found the named star you would like to observe, the guide arrows will direct you to move the telescope to the star's position. The upper left corner of the LCD screen will show the named star's ST

catalog number (the IntelliScope's entire ST catalog is printed in Appendix F for easy reference), and the lower left shows the constellation in which the star resides. Pressing Enter again will display the star's R.A. and Dec. coordinates, its magnitude, and a brief description.

To find another named star to observe, simply continue scrolling through the list of named stars.

Double (and Multiple) Stars

Many stars in the night sky appear to be single stars, but they are not. They are actually double or multiple star systems. Some of these systems comprise two or more stars gravitationally bound to each other, while others are just two (or more) stars in the same line of sight. At high magnifications, it is possible to "split" many double (and multiple) stars into their individual components. It can also be interesting to contrast and compare the different colors and magnitudes of the stars in the system. Be aware, however, that good seeing conditions are critical for separating close components of a double or multiple star.

To select a double (or multiple) star to observe, press Enter after selecting "DOUBLE" from the Star button choices. The LCD screen will then display the word "DOUBLE" with a flashing three-letter constellation designation after it. Now, select the constellation in which you would like to view a double star. Use the arrow buttons to scroll through the list of constellations. If you are unsure which constellation the three-letter designation represents, refer to Appendix E. Once you have selected the constellation, press Enter. A double star in that constellation will now appear on the LCD screen, along with the guide arrows to lead you to the double star. The current constellation is shown in the lower left, and the double star's name is in the lower right.

Note: Double stars typically have names like "Zeta" (Greek letter designation) or a number like "36" (Flamsteed number). The full names for these double stars are actually linked to the constellation they reside in. For example, in the constellation Andromeda, these stars would be "Zeta And" and "36 And."

For more information about the double star selected, press the Enter button. (The "S=" now refers to the separation, in arc-seconds, between the double stars. For multiple stars, the "S=" refers to the separation between the two brightest stars. The "M=" now refers to the magnitude of the brightest star.) To go to the next double star in the selected constellation, simply press the up arrow button. The guide arrows will now direct you to the next double star in the constellation. If there are no more double stars available in that constellation, a double star from the next constellation (in alphabetical order) will be displayed. To select another constellation in which to view a double star, press the Star button, select "DOUBLE", and press Enter.

Variable Stars

Variable stars are stars that change their brightness, also called magnitude, over time. The period of brightness change varies greatly from star to star; some variable stars change brightness over several days while others may take several months to noticeably change. It is fun and challenging to watch a star's magnitude change over time. Observers typically com-

pare the current brightness of the variable star to other stars around it (whose magnitudes are known and do not change over time).

To select a variable star to observe, press Enter after selecting "VARIABLE" from the Star button choices. The LCD screen will then display the word "VARIABLE" with a flashing three-letter constellation designation after it. Now, select the constellation in which you would like to view a variable star. Use the arrow buttons to scroll through the list of constellations. If you are unsure which constellation the three-letter designation represents, refer to Appendix E. Once you have selected the constellation, press Enter. A variable star in that constellation will now appear on the LCD screen, along with the guide arrows to lead you to the variable star. The current constellation is shown in the lower left, and the variable star's name is in the lower right.

Note: Variable stars typically have names like "Eta" (Greek letter designation) or a letter designation like "R." The full names for these variable stars are actually linked to the constellation they reside in. For example, in the constellation Aquila, these stars would be "Eta Aql" and "R Aql."

For more information about the variable star selected, press the Enter button. (The "M=" refers to the mean magnitude of the variable star.) To go to the next variable star in the selected constellation, simply press the up arrow button. The guide arrows will now direct you to the next variable star in the constellation. If there are no more variable stars available in that constellation, a variable star from the next constellation (in alphabetical order) will be displayed. To select another constellation in which to view a variable star, press the Star button, select "VARIABLE," and press Enter.

Catalog (ST) Stars

The "ST" catalog contains all of the stars in the IntelliScope Computerized Object Locator's database. This catalog has 837 of the most interesting stars to view in the night sky. The full list of stars appearing in the ST catalog is printed Appendix F. Generally, the best way to use the ST catalog to observe stars is first to peruse Appendix F, and then note the catalog number of the star you wish to observe.

To select an ST catalog star to observe, press Enter after selecting "CATALOG" from the Star button choices. The LCD screen will then display the letter "ST" with three digits blinking after it. Now, input the ST catalog number of the star you wish to observe, and press Enter. If the ST catalog number of the star you wish to view contains three digits, it is not necessary to press Enter after inputting the third digit.

The object's ST catalog designation will be shown in the upper left corner of the LCD screen, with the guide arrows in the upper right. The lower left will show the constellation the object resides in and the star's name.

You can get more information on the star selected by pressing the Enter button. The second line of the LCD screen will then cycle information about the object you are viewing, such as its celestial coordinates (R.A. and Dec.), magnitude (brightness), and a brief description.

When you are finished viewing the selected star, you may scroll to another star in the ST catalog by using the arrow buttons, or you can select another ST catalog star to view by pressing the Star button, and pressing Enter once "CATALOG" is selected.

G. Tours of the Best Objects

The IntelliScope controller offers guided tours of the best and brightest celestial objects visible in the sky each month. There are 12 monthly tours, each consisting of 12 preselected objects. The tours are an easy and fun way to locate and observe the finest wonders of the heavens. They are a great place to start for a beginner who is unfamiliar with the night sky, or for a more experienced observer who wants to revisit some old favorites or show friends or family "what's up" on a given evening.

Starting a Tour

To start an IntelliScope tour, press the Tour button at any time after you have aligned the IntelliScope system. The LCD screen will display "SKY TOUR" and a flashing three-letter designation for the month. Scroll through the months by using the arrow buttons until you reach the present month, then press the Enter button.

The LCD screen will then display the first tour object for the selected month in the lower right of the screen, with the guide arrows in the upper right. Use the guide arrows to point the telescope, and you will soon be observing the first astronomical showpiece of the month.

You can get more information about the current tour object by pressing the Enter button. The second line of the LCD screen will then cycle the following information about the object you are viewing: its celestial co-ordinates (R.A. and Dec.), magnitude (brightness), size (in arc minutes or seconds), and a brief text description.

When you have finished viewing the first tour object for the selected month, you can continue the tour by pressing the up arrow button to find the next object. You can exit the tour at any time by pressing any one of the other function buttons on the controller.

Since several months' tour objects are visible in the night sky at one time, feel free to select a month before or after the current month. These tour objects will likely be visible also. Remember, however, that viewing objects below 40° or so from the horizon will not give the best view due to atmospheric distortion (and usually light pollution). If you are finding that objects in the selected tour month are too close to the horizon, you should choose a month following the selected month, or you can wait a few hours for the objects to rise higher in the sky!

H. The Identify Function

There may come a time in your observations when you spot an unidentified deep-sky object or star in the eyepiece and want to know what it is. With the IntelliScope Computerized Object Locator, a simple press of a button will tell you.

Using the ID Button

When you locate an object and center it in the eyepiece, you can identify it by simply pressing the ID button. The LCD screen

will display "IDENTIFY" with the word "ANY" flashing. You can then use the up/and down arrow buttons to scroll through several more specific options ("STAR", "DOUBLE", "CLUSTER", "NEBULA", and "GALAXY"). If you know which one of these object types you are looking at, selecting the object type will make the identification quicker and more accurate. This is because the computer will search through a shorter list of potential object matches, and will allow proper identification if there are several objects within the same field of view. If you are unsure of the object type you are looking at, simply select "ANY" from the list of choices. Once you have selected the object type (or "ANY"), press the Enter button.

The identity of the object centered in the eyepiece will now be displayed in the lower right area of the LCD screen. The constellation in which the object resides is shown in the lower left. As always, to get more information about the object, press the Enter button.

An interesting feature of the ID function is that once initiated, it is continually active. So, if you press the ID button, and choose "STAR", for instance, you can move your telescope from star to star in the sky, and the controller will automatically display the star's identity when you center the star in the eyepiece. This can be a fun and easy way to identify the stars in the sky. In fact, you can even make a "Name That Star" game out of it! Point your finger at a bright star in the sky and see if you can name it. Then, just point the telescope at the star to see if you were correct or not. If the centered star is not in the controller's database, it will display the identity of the closest star that is in its database.

To exit the identify function, simply press any other of the controller's function buttons. If you would like to identify another object type, press the ID button again.

I. Adding User-Defined Objects

Not only does the IntelliScope's database contain over 14,000 fascinating objects to view, you can even add your own! Up to 99 user-defined objects can be entered into the database by means of the User button. These user-defined objects can be random stars, a faint object not contained in the controller's database, or just a pretty object that you would like to come back to at some point in the future.

To enter a user-defined object into the database, you must have the right ascension (R.A.) and declination (Dec.) coordinates for the object. If you are currently observing an object that is not in the controller's database and you wish to add it, but don't know its coordinates, you can use the FCN button to obtain its coordinates (described in next section).

To input a user-defined object, begin by pressing the User button. The LCD screen will display the word "NEW" with a two-digit number flashing after it. Since no user-defined objects currently exist, press Enter to create user-defined ("NEW") object number 01. The LCD will display the R.A. and Dec. coordinates for the "NEW" object selected in the lower left. Since no data has been input yet, these coordinates will be 00:00 +00.0. The first four digits indicate the R.A. coordinate (in R.A. hours and minutes), and the remaining digits (and the \pm sign) indicate the Dec. coordinate (in degrees). Now, press

the Enter button, and the first two digits of the R.A. coordinate (R.A. hours) will begin flashing. Press the two numerical buttons on the keypad that correspond to the hours value of the R.A. coordinate. If the value of the R.A. hours is less than 10, make sure to enter a zero first. Then the second two digits of the R.A. coordinate (R.A. minutes) will begin flashing. Press the two numerical buttons that correspond to the minutes value of the R.A. coordinate. If the R.A. minutes are less than 10, make sure to enter a zero first. Next, the sign of the Dec. coordinate will be flashing. Use the arrow buttons to select "+" or "-" for the Dec. coordinate. Then, the first two digits of the Dec. coordinate will begin flashing. Press the two numerical buttons that correspond to the degrees value of the Dec. coordinate. Then the tenth of a degree value for the Dec coordinate will begin flashing. Press the numerical button that corresponds to the tenths of a degree value for the Dec. coordinate.

You have now input the data for your first user-defined object. Remember that this object is now "NEW01". If you wish to view this object in the future, press the User button, and press Enter once "NEW01" is selected. The guide arrows will then tell you where to point your telescope to find the user-defined object.

If you wish to input another user-defined object, select "NEW02" (by using numerical buttons or the arrow buttons) after pressing the User button and input the data as outlined previously. If you select a "NEW" object number that you have already entered coordinates for and attempt to input new data, you will lose the data that was input previously. You may find it convenient to keep a written log of the "NEW" objects so that you can easily keep track of them.

J. The Function (FCN) Button

The IntelliScope Computerized Object Locator has several other useful functions, a couple of which can be accessed by using the FCN (function) button.

R.A. and Dec. Coordinates

By simply pressing the FCN button, the controller will give a continuous readout of the telescope's current R.A. and Dec. coordinates. This can be helpful and powerful in a number of ways. You can easily find any object in the night sky if you know its right ascension and declination coordinates. Grab any star atlas, choose any object you wish to view, be it faint galaxy or random star, and jot down its coordinates. Then, once you have aligned the IntelliScope system, you can point the telescope to that location by simply pressing the FCN button and moving the telescope until the R.A. and Dec. coordinates displayed match the coordinates of the object you wish to view. You can also press the FCN button at any time to display the current R.A. and Dec. coordinates of whatever you are currently viewing.

A common use for the FCN button is to locate "transient" objects, such as comets and asteroids. To find these objects you will need to learn their coordinates from astronomy resources, such as Astronomy or Sky & Telescope magazines or a reliable astronomy website. Comet and asteroid positions will change from night to night, so entering the current coordinates into the user-defined database is generally not useful.

After pressing the FCN button, the R.A. and Dec. coordinates corresponding to the center of the telescope's field of view are displayed on the first line of the LCD screen. The lower left of the screen indicates the current constellation the telescope is pointing to. The lower right numbers are the current azimuth ("AZ") and altitude ("ALT") coordinates of the telescope; this information is generally not useful.

The Realignment Function

This function is useful for obtaining a new alignment fix during an observing session to correct for small pointing errors. Use this function only when pointing accuracy for a certain area of the sky appears to be poor compared to other areas of the sky. This is evident when objects in one area of the sky consistently fall at the edge or just outside the field of view (of the 25mm eyepiece) when the numbers on the LCD screen read 0.0 0.0. This can happen if the alignment stars initially chosen during setup are somewhat close to each other (less than 60° apart) or if the area of sky being viewed is a considerable distance away from the alignment stars chosen.

To improve pointing accuracy in a specific area of the sky, select an object in the controller's database from that region, and use the guide arrows to find the object. Precisely center the object in the eyepiece (preferably a high-powered one). Now, press the FCN button, and the R.A. and Dec. coordinates of the centered object will be displayed. Then, press the Enter button. The LCD screen will now display "ALIGN OBJECT 3" on the first line, and will be flashing the object currently centered in the telescope on the second line. Pressing Enter again then realigns the IntelliScope system to the object centered in the telescope. The LCD screen will display a new "warp factor" associated with the new alignment. If this number is greater than ±0.5, you may want to consider resetting the controller to perform another two-star alignment. Turn the controller off, then on again (with the Power button), to do this.

If, instead of pressing Enter a second time after pressing the FCN button, you press one of the arrow buttons, the list of initial setup alignment stars will be displayed. If you wish, you can select one of these alignment stars to realign on. Do this by scrolling to the desired alignment star using the arrow buttons, center the star in the telescope, and press Enter.

In general, it will not be necessary to use the realignment function, but it is a handy feature to have at your disposal. Also, be aware that while pointing accuracy will increase in the area of sky around the object realigned on, it may decrease in other areas of the sky.

K. The "Hidden" Functions

All of the active functions of the IntelliScope Computerized Object Locator have been outlined. There are, however, some additional "hidden" functions that may be of some use to you. To access the hidden functions, press the Enter button while pressing the Power button to turn the controller on. The LCD will display its introduction screen (with software version number) and then show the words "ALT AZM TEST." This is the first hidden function. Scroll to the other hidden functions by using the arrow buttons. The other hidden functions are "ENCODER TEST," "DOWNLOAD," "CHECKSUM," "RE-WRITE," and

"CLOCK." When the hidden function you wish to use is displayed, press Enter to select it. To exit the currently chosen hidden function, press any button except for the Enter or arrow buttons. To completely exit the hidden functions section of the controller, you will need to hold the Power button down until the controller turns off.

The rest of this section gives the details and purpose of each hidden function.

Altitude and Azimuth Test

The altitude and azimuth test ("ALT AZM TEST") is a diagnostic test that gives relative altitude and azimuth positions for the telescope. This test will allow you to easily see if the encoders are "talking" to the controller, and if the encoders are accurately monitoring the telescope's motions. To effectively use this test, make sure the telescope optical tube is in the horizontal position when pressing the Enter and Power buttons to access the hidden functions.

Once "ALT AZM TEST" is chosen from the hidden function options, the LCD screen will display the telescope's current relative altitude and azimuth position (in degrees); the relative altitude is in the upper right, while the relative azimuth is in the lower right. To begin with, both of these numbers will be +000.0. The first two sets of numbers on the upper and lower lines of the LCD screen are meaningless for the purposes of this test.

If you move the telescope counterclockwise in azimuth, the number in the lower right should increase, while if you move clockwise in azimuth, the number will decrease. If you rotate the telescope exactly 360° in azimuth, the readout should return to the original +000.0 reading.

If you move the telescope upwards in altitude, the number in the upper right should increase, while if you move downwards in altitude, the number will decrease. If the telescope tube was perfectly horizontal when you enabled the hidden functions of the controller, then the altitude will read +090.0 when the telescope is pointed precisely vertical.

If one, or both, of the encoders are not behaving properly when performing this diagnostic test, there may be a problem with the assembly of the system, or a problem with one of the encoder boards or discs. Also, be sure to check that all cable connections are secure.

Encoder Test

The encoder test is another diagnostic test that gives information about the performance of the encoders themselves. Select "ENCODER TEST" from the list of hidden functions using the arrow buttons and press Enter.

The LCD screen will now display two lines of data. The top line of data corresponds to the altitude encoder, while the lower line of data corresponds to the azimuth encoder. The first two digits on each line denote the amplitude of the signal from one of the magnetic sensors on the encoder board, the second two digits represent the amplitude from the other sensor on the encoder board. The numbers are in hexadecimal (base 16) digits. Therefore "A" in hexadecimal represents "11" in decimal, "B" represents "12" in decimal, "C" represents "13," "D" repre-

sents “14,” “E” represents “15,” and “F” represents “16.” When moving the telescope in altitude or azimuth, you will note that each of the digit pairs rises and falls. None of the digit pairs should ever go above “F3.” If they do, then the encoder disk is too close to the sensors on the encoder board. This will generally not happen in altitude, but can happen in azimuth.

If you notice that the first or second digit pair on the second line of the display goes above “F3,” then try loosening the lock nut on the azimuth nut of the base by about 1/16 turn. If this does not work, you will need to disassemble the azimuth encoder (azimuth encoder disk, brass bushing, and azimuth encoder board) and reassemble it carefully according to the assembly instructions.

If you notice that the two digit pairs on the first line are going above “F3,” then there is a problem with your altitude encoder assembly. More than likely, the altitude encoder disk is bent.

The three-digit number displayed after the digit pairs on each line is the “radius” for each encoder. This number should not go above about 125 or below about 30. If it does, performance may be compromised for the corresponding encoder. If the number goes above 125, then the encoder disk and magnet may be too close to each other. If the number goes below 30, then the encoder disk and magnet may be too far away from each other. Also, if the radius varies by more than 30 counts in a cycle, encoder performance may not be optimal, and you should contact Orion Technical Support.

The four-digit number at the end of each line is the raw encoder “ticks” in hexadecimal numbers. This information will generally not be useful for diagnostic testing of the encoders.

Download

This function allows downloading of software changes and upgrades available from Orion’s website. To use this option, you must have the optional IntelliScope-to-PC cable, available from Orion. Check www.oriontelescopes.com for more information about available software downloads for the IntelliScope Computerized Object Locator.

Checksum

The checksum function is used to make sure that software has loaded into the controller properly. It has no purpose until a new software version is downloaded. Check the IntelliScope

download section on www.telescope.com to see what the proper checksum should be for each new software version.

Rewrite

Rewrite is also only used after a new software version has been downloaded. It rewrites the new software into its memory in order to prevent any potential problems from arising after the software transfer.

Clock

This function allows use of the IntelliScope system with equatorial platforms for Dobsonian telescopes. If you are using your IntelliScope with a Dobsonian equatorial platform, press Enter when the selection “CLOCK” is displayed from the available “hidden” function choices. The LCD screen will then show the word “ON” blinking. For normal operation of the IntelliScope system, the controller’s internal clock should be on. For use with a Dobsonian equatorial platform, use the up or down arrow button to change “ON” to “OFF,” and press Enter. The controller is now ready to be used with a Dobsonian equatorial platform. Now, when you press Power to turn the controller on, the LCD screen will state “CLOCK IS OFF” on the second line of its introduction screen.

To turn the controller’s internal clock back on, access the hidden functions, select “CLOCK,” press Enter, change the “OFF” back to “ON,” and press Enter again.

9. Care and Maintenance

If you give your telescope reasonable care, it will last a lifetime. Store it in a clean, dry, dust-free place, safe from rapid temperature changes and humidity. Do not store the telescope outdoors, although storage in a garage or shed is OK. Small components like eyepieces and filters should be kept in a protective box or storage case. Keep the dust caps on the front of the telescope and on the focuser when it is not in use.

The telescope requires very little mechanical maintenance. The optical tube is made of steel and has a smooth painted finish that is fairly scratch resistant. If a scratch does appear on the tube, it will not harm the telescope. Smudges on the tube can be wiped off with a soft cloth and a household cleaner.

Refer to Appendix B for detailed instructions on how to clean the optics of the StarBlast 6/6i.

10. Specifications of the StarBlast 6/6i

Primary mirror diameter:	150mm
Primary mirror:	Parabolic
Secondary mirror minor axis:	47.0mm
Focal length:	750mm
Focal Ratio:	f/5.0
Mirror Coatings:	Aluminum with SiO ₂ overcoat
Finder:	Rack-and-pinion, accepts 1.25" eyepieces
Eyepieces:	25mm and 10mm Sirius Plössl, 1.25"
Magnification:	30x (with 25mm eyepiece), 75x (with 10mm eyepiece)
Finder:	EZ Finder II reflex sight
Weight:	23 lbs., 8 oz.
Tube Length:	28 inches

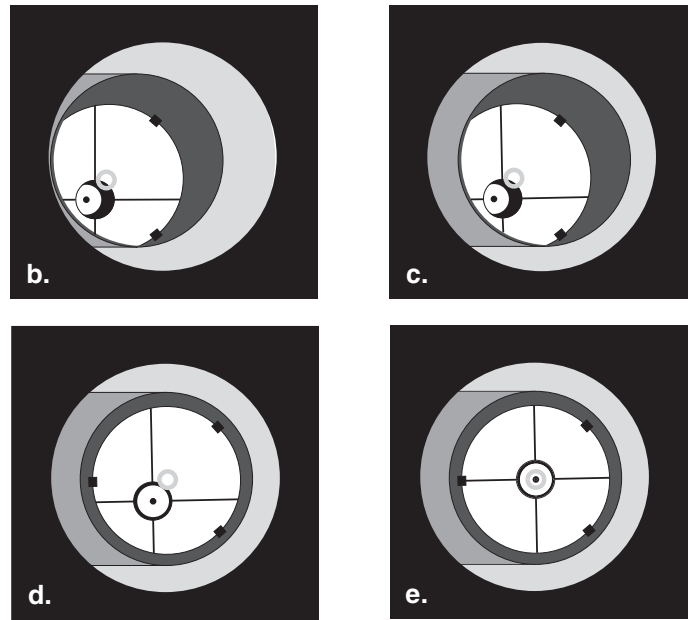
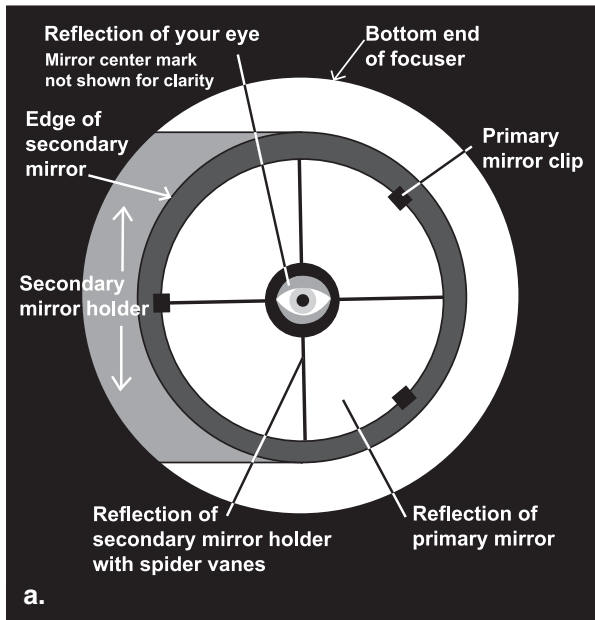

Figure 27. Collimating the optics. (a) When the mirrors are properly aligned, the view down the focuser drawtube should look like this. (b) With the collimation cap in place, if the optics are out of alignment, the view might look something like this. (c) Here, the secondary mirror is centered under the focuser, but it needs to be adjusted (tilted) so that the entire primary mirror is visible. (d) The secondary mirror is correctly aligned, but the primary mirror still needs adjustment. When the primary mirror is correctly aligned, the center “dot” of the collimation cap will be centered, as in (e).

11. Specifications of the IntelliScope System

Objects in database:

- 110 Messier (M) objects
- 7840 New General Catalog (NGC) objects
- 5386 Index Catalog (IC) objects
- 8 Major planets
- 99 User-defined objects

Computer interface: RS-232 port

Power: Requires one 9V battery

This device complies with Part 15 of the FCC Rules. Operation is subject to the following two conditions: (1) this device may not cause harmful interference, and (2) this device must accept any interference received, including interference that may cause undesired operation.

Changes of modifications not expressly approved by the party responsible for compliance could void the user’s authority to operate the equipment.

Note: This equipment has been tested and found to comply with the limits for a Class B digital device, pursuant to Part 15 of the FCC Rules. These limits are designed to provide reasonable protection against harmful interference in a residential installation. This equipment generates, uses and can radiate radio frequency energy and, if not installed and used in accordance with the instructions, may cause harmful interference to radio communications. However, there is no guarantee

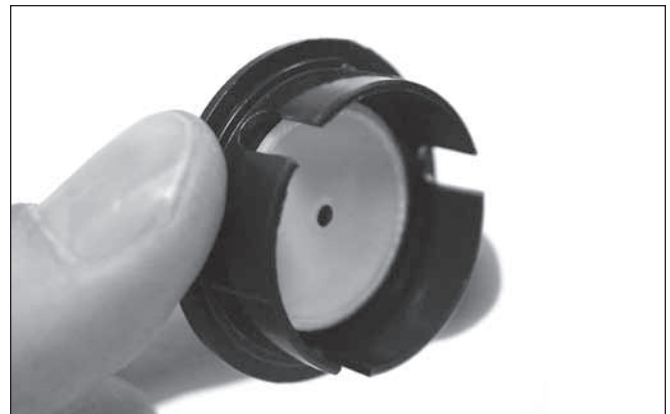

Figure 28. The quick collimation cap, which features an inner reflective surface, helps in centering reflections of the optics in the focuser during the collimation process.

that interference will not occur in a particular installation. If this equipment does cause harmful interference to radio or television reception, which can be determined by turning the equipment off and on, the user is encouraged to try to correct the interference by one or more of the following measures:

- Reorient or relocate the receiving antenna.
- Increase the separation between the equipment and receiver.
- Connect the equipment into an output on a circuit different from that to which the receiver is connected.
- Consult the dealer or an experienced radio/TV technician for help.

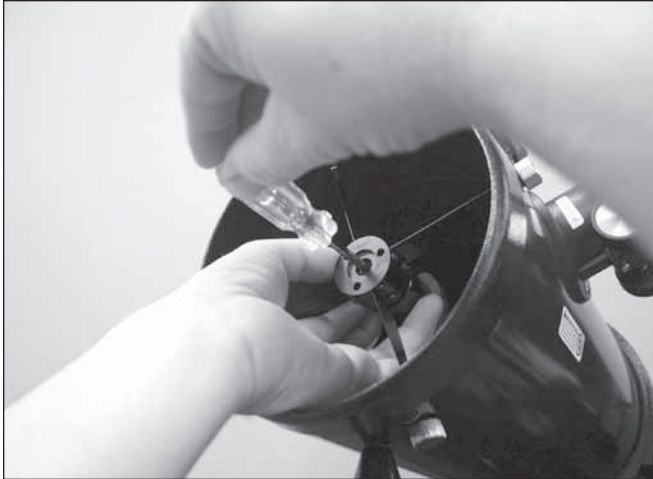

Figure 29. To center the secondary mirror under the focuser, hold the secondary mirror holder in place with your fingers while adjusting the center screw with a Phillips head screwdriver. Do not touch the mirror's surface.

- A shielded cable must be used when connecting a peripheral to the serial ports.

Appendix A: Collimating the Optics

Collimating is the process of adjusting the mirrors so they are aligned with one another. Your telescope's optics were aligned at the factory, and should not need much adjustment unless the telescope was handled roughly in transit. Accurate mirror alignment is important to ensure the peak performance of your telescope, so it should be checked regularly. Collimating is a relatively easy process and can be done in daylight or darkness.

To check collimation, remove the eyepiece and look down the focuser drawtube. You should see the secondary mirror centered in the drawtube, as well as the reflection of the primary mirror centered in the secondary mirror, and the reflection of the secondary mirror (and your eye) centered in the reflection of the primary mirror, as in **Figure 27a**. If anything is off-center, proceed with the following collimating procedure.

The Collimation Cap

Your StarBlast 6/6i comes with a “quick collimation cap” (**Figure 28**). This is a simple cap that fits on the focuser drawtube like a dust cap, but has a tiny hole in the center and a reflective inner surface. The collimation cap helps center your eye over the focuser drawtube so that aligning the optical components is easier to achieve. The reflective surface provides a distinct visual reference that is helpful in centering the mirror reflections. **Figures 27b** through **27e** assume that you have the collimation cap in place.

The Primary Mirror Center Mark

You'll notice that the primary mirror of the StarBlast 6/6i has a tiny ring (sticker) marking its center. This “center mark” allows you to achieve a very precise collimation; you don't have to guess where the exact center of the mirror is.

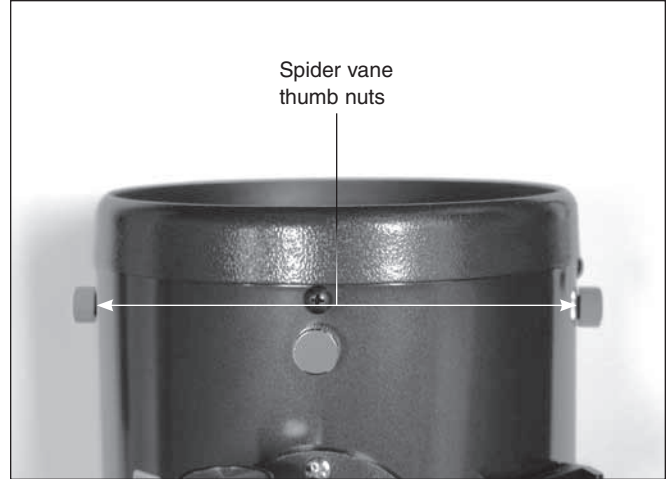

Figure 30. To center the secondary mirror radially in the focuser drawtube, make adjustments to the two knurled spider vane thumbnuts that are perpendicular to the focuser.

NOTE: The center ring sticker need not ever be removed from the primary mirror. Because it lies directly in the shadow of the secondary mirror, its presence in no way adversely affects the optical performance of the telescope or the image quality. That might seem counterintuitive, but it's true!

Preparing the Telescope for Collimating

Once you get the hang of collimating, you will be able to do it quickly even in the dark. For now, it is best to collimate in daylight, preferably in a brightly lit room and aimed at a white wall. It is recommended that the telescope tube be oriented horizontally. This will prevent any parts from the secondary mirror from falling down onto the primary mirror and causing damage if something comes loose while you are making adjustments. Place a sheet of white paper inside the optical tube directly opposite the focuser. The paper will provide a bright “background” when viewing into the focuser.

Aligning the Secondary Mirror

To adjust the secondary mirror collimation, you will need a Phillips screwdriver and a 2mm hex key, or Allen wrench.

You will need to check, and adjust if necessary, four aspects of the secondary mirror's alignment:

1. The secondary mirror's axial position
2. The secondary mirror's radial position
3. The secondary mirror's rotational position
4. The secondary mirror's tilt

The first three will probably only need to be checked and (possibly) adjusted once. Thereafter, it is usually only the secondary mirror's tilt that will need to be adjusted occasionally.

Adjusting the Secondary Mirror's Axial Position

With the collimating cap in place, look through the hole in the cap at the secondary (diagonal) mirror. Ignore the reflections for the time being. The secondary mirror itself should be centered in the focuser drawtube. If it is off-center along the axis of



Figure 31. The collimation and mirror locking thumbscrews

the telescope, i.e., positioned too far toward the front opening or toward the rear of the telescope, as it is in **Figure 27b**, you will have to adjust the mirror's axial position.

To do so, use the 2mm hex key to loosen the three small alignment set screws in the center hub of the 4-vane spider several turns. Now, grasp the mirror holder (the cylinder that is attached to the back of the secondary mirror itself) with one hand while turning the center screw with a Phillips head screwdriver with your other hand (**Figure 29**). Turning the screw clockwise will move the secondary mirror toward the front opening of the optical tube, while turning the screw counterclockwise will move the secondary mirror toward the primary mirror. When the secondary mirror is centered axially in the focuser drawtube, rotate the secondary mirror holder until the reflection of the primary mirror is as centered in the secondary mirror as possible. It may not be perfectly centered, but that is fine for now. Then, tighten the three small alignment set screws equally to secure the secondary mirror in that position.

Adjusting the Secondary Mirror's Radial Position

Like the axial position, the secondary mirror's radial position was set at the factory and will probably not need any adjusting, or if it does, you'll typically need to do it only once.

By "radial position" we mean the position of the secondary mirror along the axis perpendicular to the focuser drawtube, as shown in **Figure 30**. This position is changed by adjusting two of the spider vane thumb nuts, as shown. Loosen one thumb nut, then tighten the opposite one until the secondary mirror is centered radially in the drawtube. Do not loosen the thumb nuts too much, to avoid having them completely unthread from the ends of the spider vanes. Also, when making this adjustment, be careful not to stress the spider vanes or they could bend.

Adjusting the Secondary Mirror's Rotational Position

The secondary mirror should face the focuser squarely. If the mirror appears to be rotated away from the focuser, the mirror's rotational position will need to be adjusted. Again, this adjustment will rarely, if ever, need to be done.

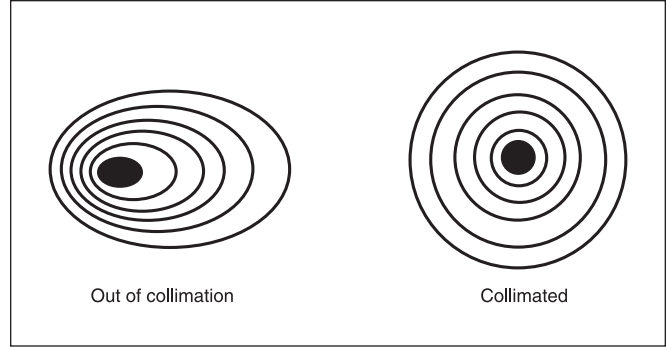

Figure 32. A star test will determine if the telescope's optics are properly collimated. An unfocused view of a bright star through the eyepiece should appear as illustrated on the right if optics are perfectly collimated. If the circle is unsymmetrical, as illustrated on the left, the scope needs collimation.

Grip the sides of the secondary mirror holder with your fingers. Then, using a Phillips screwdriver, loosen the center screw in the secondary mirror holder about a quarter of a turn only (counterclockwise). That should be enough to free up the secondary mirror to rotate slightly in either direction. Look into the collimation cap and rotate the mirror slightly in each direction to get an idea of how it affects the view of the secondary mirror. Now rotate the mirror as needed so that it precisely faces the focuser. Hold the mirror holder stationary in that position while turning the center screw clockwise until it is just tight (do not over-tighten). Sometimes the mirror may rotate slightly when tightening the screw, so keep at it until the mirror faces the focuser squarely and is secured in place.

Adjusting the Secondary Mirror's Tilt

Finally, the tilt of the secondary mirror may occasionally require adjustment. If the entire primary mirror reflection is not visible in the secondary mirror when using the collimation cap, as in **Figure 27c**, you will need to adjust the tilt of the secondary mirror. Using a 2mm hex key, first loosen one of the three alignment set screws by, say, one full turn, and then tighten the other two to take up the slack. Do not loosen the center screw during this process. The goal is to center the primary mirror reflection in the secondary mirror, as in **Figure 27d**. When it is centered, you're done adjusting the secondary mirror. Don't worry that the reflection of the secondary mirror (the dark circle with the four spider vanes adjoining it) is off-center, since that adjustment is made when aligning the primary mirror in the next step.

Aligning the Primary Mirror

The final collimation adjustment is made to the primary mirror. It will need adjustment if, as in **Figure 27d**, the secondary mirror is centered under the focuser and the reflection of the primary mirror is centered in the secondary mirror, but the reflection of the secondary mirror (dark circle containing the light reflective surface and center black "dot" of the collimation cap) is off-center.

The tilt of the primary mirror is adjusted with three spring-loaded collimation thumbscrews on the back end of the optical

tube (bottom of the primary mirror cell); these are the wide thumbscrews (**Figure 31**). The other three thin thumbscrews lock the mirror's position in place; these thin thumbscrews must be loosened before any collimation adjustments can be made to the primary mirror.

To start, turn the thin thumbscrews that lock the primary mirror in place counterclockwise a few turns each.

Now, while looking into the focuser through the collimation cap, turn one of the wide collimation thumbscrews a half turn or so in either direction and see if the secondary mirror reflection moves closer to the center of the primary. That is, does the "dot" of the collimation cap appear to move closer to the ring on the center of the primary mirror? If it does, great, keep going until you get it as close as you can. If it doesn't, try turning the collimation thumbscrew in the opposite direction. If turning the one collimation thumbscrew does not seem to bring the dot closer to the ring, try using one of the other collimation thumbscrews. It will take some trial-and-error using all three collimation thumbscrews to properly align the primary mirror. Over time you will get the feel for which collimation screws to turn to move the image in a given direction.

When you have the dot centered as much as possible in the ring, your primary mirror is collimated. Now lightly tighten the three thin locking thumbscrews to secure the primary mirror in place.

The view through the collimation cap should now resemble **Figure 27e**. A simple star test will indicate how well the telescope optics are collimated.

Star-Testing the Telescope

When it is dark, point the telescope at a bright star and accurately center it in the eyepiece's field of view. Slowly de-focus the image with the focusing knob. If the telescope is correctly collimated, the expanding disk should be a perfect circle (**Figure 32**). If the image is unsymmetrical, the scope is out of collimation. The dark shadow cast by the secondary mirror should appear in the very center of the out-of-focus circle, like the hole in a donut. If the "hole" appears off-center, the telescope is out of collimation.

If you try the star test and the bright star you have selected is not accurately centered in the eyepiece, the optics will always appear out of collimation, even though they may be perfectly aligned. It is critical to keep the star centered, so over time you will need to make slight corrections to the telescope's position in order to account for the sky's apparent motion. Point the telescope at Polaris (the north star) if you do not have a mount that tracks.

Appendix B: Cleaning the Optics

Cleaning Lenses

Any quality optical lens cleaning tissue and optical lens cleaning fluid specifically designed for multi-coated optics can be used to clean the exposed lenses of your eyepieces. Never

use regular glass cleaner or cleaning fluid designed for eyeglasses.

Before cleaning with fluid and tissue, blow any loose particles off the lens with a blower bulb or compressed air. Then apply some cleaning fluid to a tissue, never directly on the optics. Wipe the lens gently in a circular motion, then remove any excess fluid with a fresh lens tissue. Oily fingerprints and smudges may be removed using this method. Use caution; rubbing too hard may scratch the lens. On larger lenses, clean only a small area at a time, using a fresh lens tissue on each area. Never reuse tissues.

Cleaning the Mirrors

In general, your telescope's mirrors will only need to be cleaned very infrequently, if ever. Covering the front opening of the telescope with the dust cover when it is not in use will prevent dust from accumulating on the mirrors. Keeping the dust cap on the focuser's 1.25" opening is also a good idea. Improper cleaning can scratch the mirror coatings, so the fewer times you have to clean the mirrors, the better. Small specks of dust or flecks of paint have virtually no effect on the visual or imaging performance of the telescope.

The large primary mirror and the elliptical secondary mirror of your telescope are front-surface aluminized and over-coated with hard silicon dioxide, which prevents the aluminum from oxidizing. These coatings normally last through many years of use before requiring re-coating.

To clean the secondary mirror, it must be removed from the telescope. Do this by holding the secondary mirror holder stationary with your fingers (don't touch the mirror itself) while unthreading the Phillips head screw in the center hub of the 4-vane spider. Completely unthread the screw from the holder, and the holder will come loose in your fingers. Be careful not to lose the spring on the Phillips head screw.

Handle the mirror and its holder carefully. You do not need to remove the secondary mirror from its holder for cleaning. Follow the same procedure described below for cleaning the primary mirror.

To clean the primary mirror, carefully remove the mirror cell from the telescope. To do this, you must remove the four screws that connect the mirror cell to the steel tube. These screws are located on the outer edge of the mirror cell. Then pull the cell away from the tube. You will notice the primary mirror is held in the mirror cell with three clips, each held by two mirror clip anchor screws. Using a Phillips screwdriver, unthread the mirror clip anchor screws and remove the clips.

Next, hold the mirror by its edge, and remove it from the mirror cell. Be careful not to touch the aluminized surface of the mirror with your fingers. Set the mirror on a clean, soft towel. Fill a clean sink, free of abrasive cleanser, with room-temperature water, a few drops of liquid dishwashing detergent, and if possible, a cap-full of rubbing alcohol. Submerge the mirror (aluminized face up) in the water and let it soak for several minutes (or hours if it is a very dirty mirror). Wipe the mirror underwater with clean cotton balls, using extremely light pressure and stroking in straight lines across the surface. Use one ball for each wipe across the mirror. Then rinse the mirror under a

stream of lukewarm water. Any particles on the surface can be swabbed gently with a series of clean cotton balls, each used just one time.

Dry the mirror in a stream of air (a “blower bulb” works great), or remove any stray drops of water with the corner of a paper towel. Dry the bottom and the edges with a towel (not the mirror surface!). Leave the entire assembly in a warm area until it is completely dry before replacing it in the mirror cell. Then reinstall the mirror cell in the telescope optical tube with the four screws.

Appendix C: Troubleshooting the IntelliScope System

This section is intended to help you if you are encountering any problems with your IntelliScope system. If this information is not useful to you in determining the source of the problem, contact Orion Technical Support by email at support@telescope.com, or call (800) 676-1343.

Check the Azimuth Encoder and Encoder Board

1. Is the azimuth axis screw's hex lock nut tight enough? Is it too tight? Remember, it should be tightened 3/16 to 1/4 turn past when the fender washer is no longer loose under the nut.
2. Does the brass bushing extend slightly above the top surface of the top baseplate? If not, the bushing or top baseplate may need replacement, or there may be an assembly problem.

3. Is the azimuth encoder disk bent? If so, you will need to flatten it by bending.
4. Is the brass bushing properly registered with the azimuth encoder disk? The feature on the wide end of the bushing needs to seat into the hole in the disk.

Check the Altitude Encoder and Encoder Board

5. Did you install the altitude encoder disk onto the telescope mounting bracket with the three small machine screws? If you didn't and the disk is free to rotate on the mounting bracket shaft, the IntelliScope system will not work.
6. Did you install the aluminum spacer ring on the telescope mounting bracket shaft after you attached the encoder disk? The spacer ring is important for maintaining the correct spacing between the altitude encoder disk and the sensors on the encoder board.
7. Is the compression spring seated in its hole just below the hole for the telescope mounting bracket shaft? Does it make contact with the altitude encoder board when the board is in place? This is also important for maintaining the correct spacing between the altitude encoder disk and the sensors on the encoder board.

Warp factor consistently above ± 0.5 but below ± 2.0

8. Check accuracy of vertical stop. Use a carpenter's level to do this.
9. Are alignment stars being centered with reasonable precision? A high-power eyepiece (at least 10mm focal length), or an illuminated reticle eyepiece (preferred) is recommended.

-
10. Check encoders as outlined previously.
 11. Try to use alignment stars that are well above the horizon. Light from stars is refracted as it travels through the atmosphere and starlight near the horizon has to travel through the greatest amount of atmosphere before reaching your telescope. Stars near the horizon can appear as much as 2° away from their actual position.
 12. Avoid long delays between aligning on the first and second alignment stars. The stars in the night sky appear to move due to the rotation of the Earth. If you take more than a few minutes to align on the second star, this stellar motion will result in an increase in the warp factor (and decrease the resultant pointing accuracy). This is because the controller does not yet have a frame of reference to tell which way the stars should appear to be moving before the second star is aligned on.

Warp numbers larger than 2.0

13. Are the stars you aligned on actually the stars you selected on the controller? Consult the finder charts in Appendix D if you are unsure.
14. The encoder sensors may be coming into contact with the encoder disks. Check both the altitude and azimuth encoders as outlined above.

Altitude readouts do not change when you move the scope (during "ALT AZM TEST")

15. Check the altitude cable's connections.
16. Make sure the altitude tension knob is not too loose.

Azimuth readouts do not change when you move the scope (during "ALT AZM TEST")

17. Check the azimuth cable's connections.
18. Make sure the hex lock nut on the azimuth axis screw is tight. The fender washer underneath the hex lock nut should not be able to move. Remember, the hex lock nut should be tightened about $3/16$ to $1/4$ turn beyond the point where the washer cannot move any longer.
19. Try disassembling then reassembling the azimuth encoder by disassembling the top and bottom baseplates.

Appendix D: Alignment Star Finder Charts

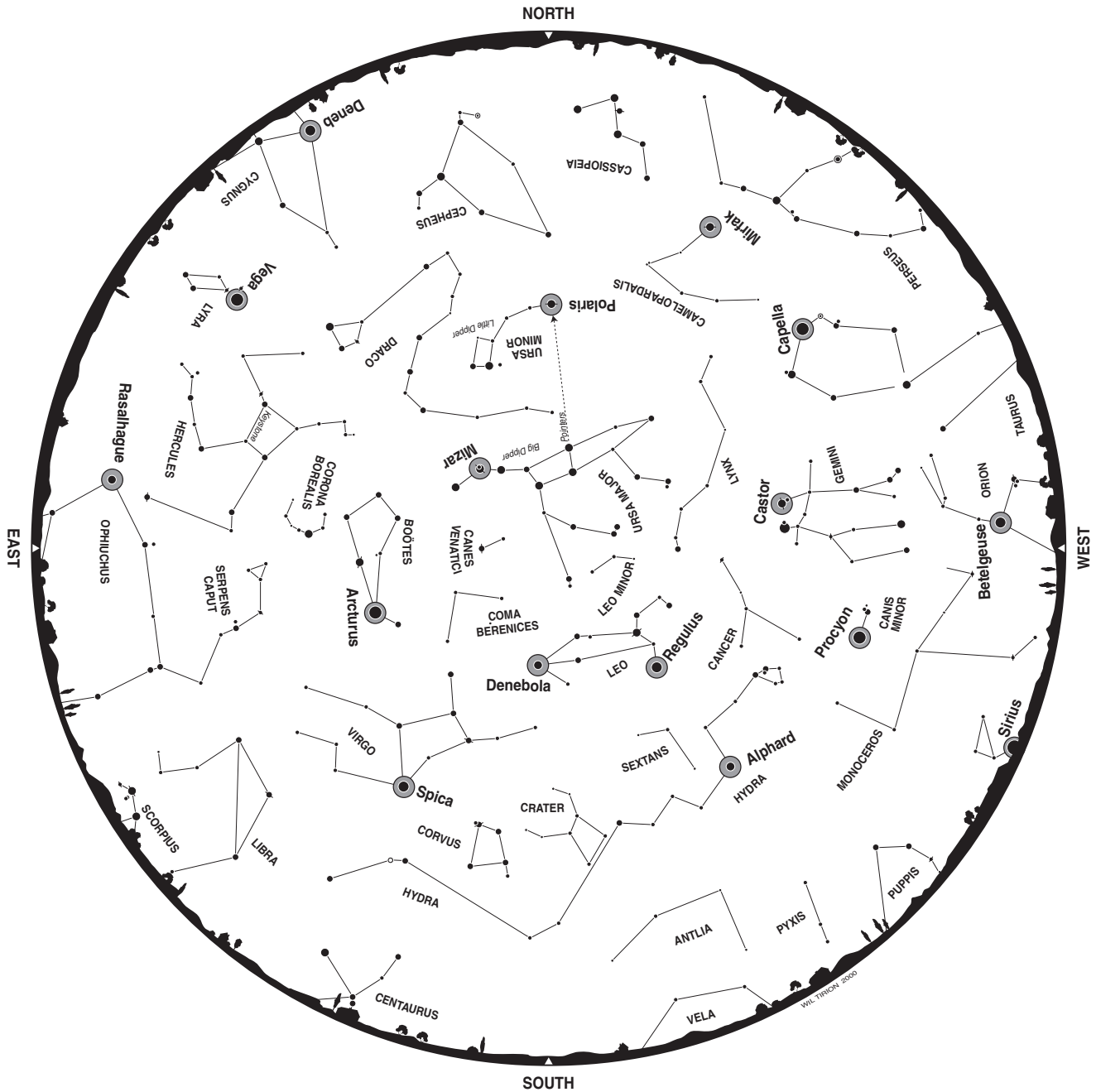

SPRING	
Early March	1:00 AM
Late March	12:00 AM
Early April	12:00 AM*
Late April	11:00 PM*
Early May	10:00 PM*
Late May	9:00 PM*
Early June	8:00 PM (dusk)*

*Daylight saving time

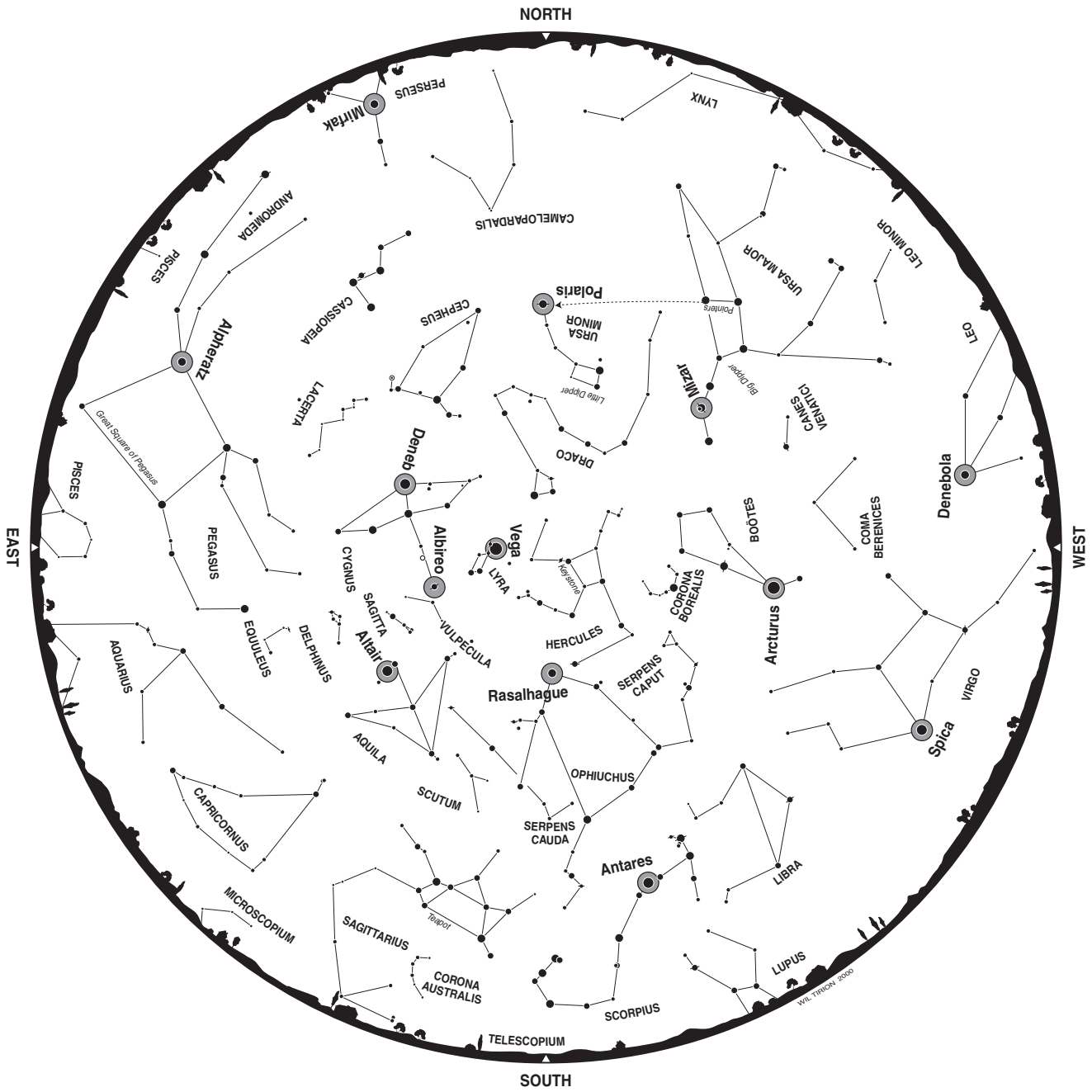

SUMMER	
Early June	2:00 AM*
Late June	1:00 AM*
Early July	12:00 AM*
Late July	11:00 PM*
Early August	10:00 PM*
Late August	9:00 PM*
Early September	8:00 PM (dusk)*

*Daylight saving time

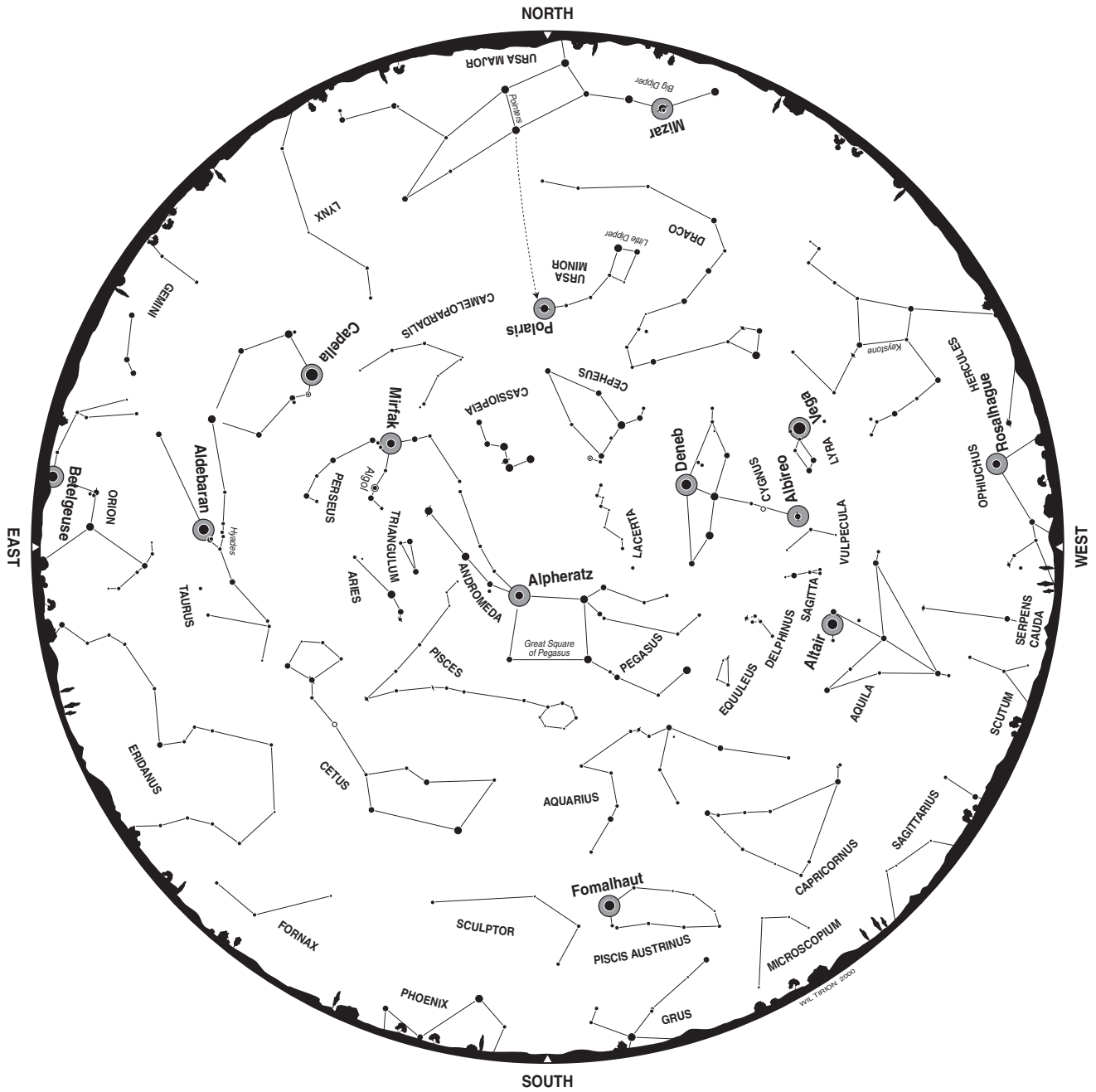

AUTUMN	
Early September	2:00 AM*
Late September	1:00 AM*
Early October	12:00 AM*
Late October	11:00 PM*
Early November	9:00 PM
Late November	8:00 PM
Early December	7:00 PM

*Daylight saving time

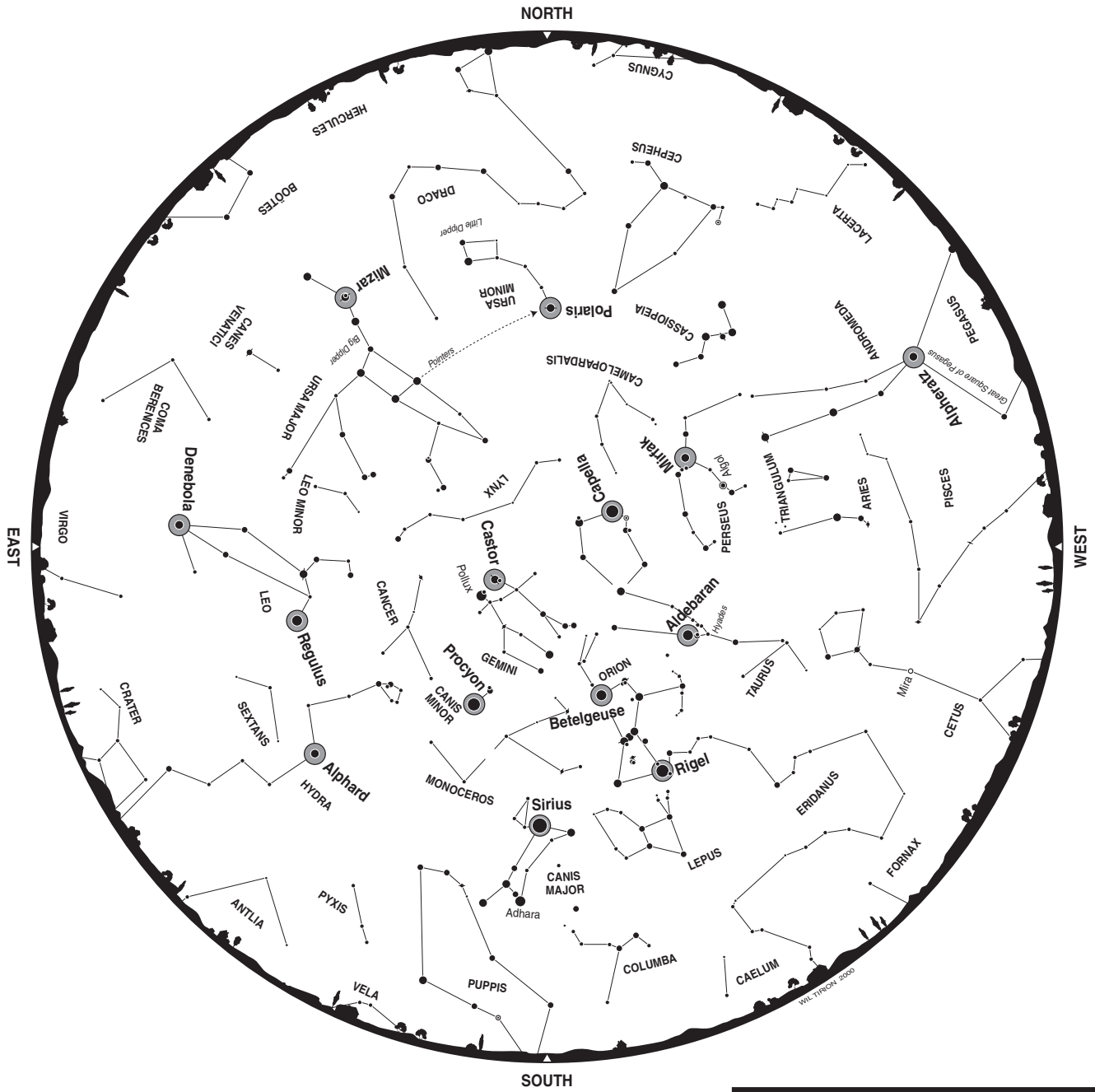

WINTER	
Early December	2:00 AM
Late December	1:00 AM
Early January	12:00 AM
Late January	11:00 PM
Early February	10:00 PM
Late February	9:00 PM
Early March	8:00 PM

Appendix E: Constellation Abbreviations

And	Andromeda	CVn	Canes Venatici	Ori	Orion
Ant	Antlia	Cyg	Cygnus	Pav	Pavo
Aps	Apus	Del	Delphinus	Peg	Pegasus
Aql	Aquila	Dor	Dorado	Per	Perseus
Aqr	Aquarius	Dra	Draco	Phe	Phoenix
Ara	Ara	Equ	Equuleus	Pic	Pictor
Ari	Aries	Eri	Eridanus	PsA	Piscis Austrinus
Aur	Auriga	For	Fornax	Psc	Pisces
Boo	Boötes	Gem	Gemini	Pup	Puppis
Cae	Caelum	Gru	Grus	Pyx	Pyxis
Cam	Camelopardalis	Her	Hercules	Ret	Reticulum
Cap	Capricorn	Hor	Horologium	Scl	Sculptor
Car	Carina	Hya	Hydra	Sco	Scorpius
Cas	Cassiopeia	Hyi	Hydrus	Sct	Scutum
Cen	Centaurus	Ind	Indus	Ser	Serpens
Cep	Cepheus	Lac	Lacerta	Sex	Sextans
Cet	Cetus	Leo	Leo	Sge	Sagitta
Cha	Chamaeleon	Lep	Lepus	Sgr	Sagittarius
Cir	Circinus	Lib	Libra	Tau	Taurus
Cnc	Cancer	LMi	Leo Minor	Tel	Telescopium
CMa	Canis Major	Lup	Lupus	TrA	Triangulum Australe
CMi	Canis Minor	Lyn	Lynx	Tri	Triangulum
Col	Columba	Lyr	Lyra	Tuc	Tucana
Com	Coma Berenices	Men	Mensa	UMa	Ursa Major
CrA	Corona Australis	Mic	Microscopium	UMi	Ursa Minor
CrB	Corona Borealis	Mon	Monoceros	Vel	Vela
Crt	Crater	Mus	Musca	Vir	Virgo
Cru	Crux	Nor	Norma	Vol	Volans
Crv	Corvus	Oct	Octans	Vul	Vulpecula
		Oph	Ophiuchus		

Appendix F: ST Catalog

Number	Name	Other	RA	Dec	Mag	Sep	Con	Code	
ST001	O Σ 254		00 01.2	+60 21	7.6	59"	Cas	5	colored double star
ST002	30		00 02.0	-06.0	4.4	*	Psc	1	red variable star
ST003	Σ 3053		00 02.6	+66 06	5.9	15"	Cas	5	colored double star
ST004	SU		00 04.6	+43.5	8	*	And	1	red variable star
ST005	Ced214		00 04.7	+67.2	7.8	30'	Cep	130	emission nebula
ST006	Σ 3062	ADS 61	00 06.3	+58.4	6.4	1.5"	Cas	4	double star challenge
ST007	Alpheratz	Alpha	00 08.4	+29 05	2.1	*	And	21	star
ST008	Σ 2	ADS 102	00 09.3	+79.7	6.6	0.8"	Cep	4	double star challenge
ST009	Kappa	β 391	00 09.4	-28 00	6.2	2"	Scl	4	double star challenge
ST010	Algenib	Gamma	00 13.2	+15.2	2.8	*	Peg	21	star
ST011	AD	ADS 180	00 14.5	-07.8	4.9	1.5°	Cet	1	red variable star
ST012	7		00 14.6	-18.9	4.4	*	Cet	1	red variable star
ST013	Σ 12	"35, UU"	00 15.0	+08 49	5.8	12"	Psc	5	colored double star
ST014	S		00 15.4	-32.1	5.5	*	Scl	22	variable star
ST015	Σ 13		00 16.2	+76.9	7	0.9"	Cep	4	double star challenge
ST016	ST		00 17.6	+50.3	9	*	Cas	1	red variable star
ST017	Groombridge34	ADS 246	00 18.1	+44.0	8	39"	And	2	double star
ST018	Σ 24		00 18.5	+26 08	7.6	5"	And	2	double star
ST019	Iota		00 19.4	-08.8	3.5	*	Cet	21	star
ST020	VX		00 19.9	+44.7	8	*	And	21	star
ST021	R		00 24.0	+38 35	5.8	Stellar	And	22	variable star
ST022	Σ 30		00 27.2	+49 59	6.9	15"	Cas	2	double star
ST023	AQ		00 27.6	+35.6	6.9	*	And	1	red variable star
ST024	Beta	Lacaille 119	00 31.5	-63.0	4.4	27"	Tuc	2	double star
ST025	Σ 36	ADS 449	00 32.4	+06.9	5.7	28"	Psc	2	double star
ST026	Zeta	17	00 37.0	+53.9	3.7	*	Cas	21	star
ST027	Delta		00 39.3	+30.9	3.3	*	And	21	star
ST028	55		00 39.9	+21 26	5.4	6"	Psc	5	colored double star
ST029	Schedar	Alpha	00 40.5	+56.5	2.2	*	Cas	21	star
ST030	O Σ 18	ADS 588	00 42.4	+04.2	7.8	1.5"	Psc	4	double star challenge
ST031	HN122	ADS 624	00 45.7	+75.0	5.7	36"	Cas	2	double star
ST032	Delta		00 48.7	+07.6	4.4	*	Psc	21	star
ST033	Eta		00 49.1	+57 49	3.4	12"	Cas	5	colored double star
ST034	65	ADS 683	00 49.9	+27.7	6.3	4.4"	Psc	5	colored double star
ST035	Do13		00 50.0	+64.1	11	13'	Cas	120	scattered group of stars
ST036	Lambda1	Dunlop 2	00 52.4	-69.5	6.5	21"	Tuc	2	double star
ST037	36	ADS 755	00 55.0	+23.6	6	0.8"	And	4	double star challenge
ST038	Navi	"Gamma, Tsih"	00 56.7	+60.7	2.5	*	Cas	21	star

Number	Name	Other	RA	Dec	Mag	Sep	Con	Code	
ST039	Σ80		00 59.4	+00 47	8.4	26"	Cet	3	double star equal magnitude
ST040	Σ79		01 00.1	+44 43	6	8"	And	3	double star equal magnitude
ST041	U		01 02.3	+81 51	6.8	Stellar	Cep	22	variable star
ST042	Σ88	74	01 05.6	+21 28	5.3	30"	Psc	3	double star equal magnitude
ST043	Σ90	77	01 05.8	+04 55	6.8	33"	Psc	2	double star
ST044	Zeta	Rumker 2	01 08.4	-55.3	3.9	6.4"	Phe	2	double star
ST045	Eta		01 08.6	-10.2	3.5	*	Cet	21	star
ST046	Lux Lydiae	SAO 181	01 08.7	+86.3	4.3	*	Cep	21	star
ST047	Mirach	Beta	01 09.7	+35.6	2	*	And	21	star
ST048	Zeta	ADS 996	01 13.7	+07.6	5.6	23"	Psc	2	double star
ST049	Kappa	h3423	01 15.8	-68.9	5.1	5.4"	Tuc	2	double star
ST050	Z		01 16.2	+25.8	8.8	*	Psc	21	star
ST051	Σ113	42	01 19.8	-00 31	6.4	1.6"	Cet	4	double star challenge
ST052	Psi	ADS 1129	01 25.9	+68.1	4.7	25"	Cas	9	double star magnitude contrast
ST053	R		01 27.0	-32.5	6.1	*	Scl	22	variable star
ST054	Gamma		01 28.4	-43.3	3.4	4'	Phe	21	star
ST055	Achernar	Alpha	01 37.7	-57 14	0.5	*	Eri	21	star
ST056	51		01 38.0	+48.6	3.6	*	And	21	star
ST057	UV		01 38.8	-18.0	7	*	Cet	22	variable star
ST058	p	Dunlop 5	01 39.8	-56.2	5.8	11.5"	Eri	2	double star
ST059	Nu	106	01 41.4	+05.5	4.4	*	Psc	21	star
ST060	44	Burnham 1103	01 43.3	+60.6	5.8	1.6"	Cas	2	double star
ST061	Phi		01 43.7	+50.7	4.1	*	Per	21	star
ST062	Σ162		01 49.3	+47 54	5.8	2"	Per	8	triple star challenge
ST063	Σ174	1	01 50.1	+22.3	6	2.6"	Ari	2	double star
ST064	Σ163		01 51.3	+64 51	6.6	35"	Cas	5	colored double star
ST065	Baten Kaitos	Zeta	01 51.5	-10.3	3.7	3'	Cet	2	double star
ST066	Σ178		01 52.0	+10 48	8.5	3"	Ari	3	double star equal magnitude
ST067	Σ180	Gamma	01 53.5	+19.3	4.5	8"	Ari	3	double star equal magnitude
ST068	Psi		01 53.6	-46.3	4.4	5°	Phe	1	red variable star
ST069	Epsilon	45	01 54.4	+63.7	3.4	*	Cas	21	star
ST070	Σ186	ADS 1538	01 55.9	+01.9	6.8	1"	Cet	4	double star challenge
ST071	56	ADS 1534	01 56.2	+37.3	5.7	3'	And	2	double star
ST072	Lambda	ADS 1563	01 57.9	+23.6	4.8	37"	Ari	2	double star
ST073	Upsilon		02 00.0	-21.1	4	*	Cet	21	star

Number	Name	Other	RA	Dec	Mag	Sep	Con	Code	
ST074	Σ202	Alpha	02 02.0	+02.8	4	1.6"	Psc	4	double star challenge
ST075	Almach	Gamma	02 03.9	+42.3	2.2	10"	And	5	colored double star
ST076	Hamal	Alpha	02 07.2	+23.5	2	*	Ari	21	star
ST077	59		02 10.9	+39 02	5.6	16"	And	5	colored double star
ST078	Iota	ADS 1697	02 12.4	+30.3	5	3.8"	Tri	5	colored double star
ST079	Σ231	66	02 12.8	-02.4	5.7	16.5"	Cet	2	double star
ST080	Σ228	ADS 1709	02 14.0	+47.5	6.6	1.1"	And	4	double star challenge
ST081	Σ232		02 14.7	+30 24	8	7"	Tri	3	double star equal magnitude
ST082	Σ239		02 17.4	+28 44	7	14"	Tri	2	double star
ST083	Mira	Omicron	02 19.3	-03.0	2	*	Cet	22	variable star
ST084	Iota		02 29.1	+67.4	4	2.2"	Cas	6	triple star
ST085	Σ268		02 29.4	+55 31	6.9	3"	Per	2	double star
ST086	Σ274		02 31.5	+01 05	7.3	14"	Cet	3	double star equal magnitude
ST087	Polaris	Alpha	02 31.8	+89 16	2	18"	UMi	2	double star
ST088	Omega	h 3506	02 33.9	-28 13	5	11"	For	2	double star
ST089	30		02 37.0	+24 38	6.5	39"	Ari	5	colored double star
ST090	R	R TRI	02 37.0	+34.3	5.4	*	Tri	22	variable star
ST091	Σ299	Gamma	02 43.3	+03.2	3.6	2.7"	Cet	2	double star
ST092	Σ305		02 47.5	+19 22	7.4	3"	Ari	4	double star challenge
ST093	RZ		02 48.9	+69 38	6.2	Stellar	Cas	22	variable star
ST094	pi		02 49.3	+17 28	5.2	3"	Ari	6	triple star
ST095	Σ307	Eta	02 50.7	+55 53	3.9	28"	Per	9	double star magnitude contrast
ST096	R		02 53.9	-49.9	4.7	*	Hor	22	variable star
ST097	Σ330	ADS 2237	02 57.2	-00.6	7.3	9"	Cet	2	double star
ST098	Acamar	Theta	02 58.3	-40.3	3.5	8"	Eri	2	double star
ST099	Σ333	Epsilon	02 59.2	+29.3	4.6	1.4"	Ari	4	double star challenge
ST100	Epsilon		02 59.2	+21 20	4.6	1"	Ari	4	double star challenge
ST101	Σ331		03 00.8	+52 20	5.4	12"	Per	2	double star
ST102	Menkar	Alpha	03 02.3	+04.1	2.5	*	Cet	21	star
ST103	Rho	25	03 05.2	+38.8	3.4	*	Per	1	red variable star
ST104	Σ320		03 06.2	+79 24	5.8	5"	Cep	5	colored double star
ST105	h3568		03 07.5	-79.0	5.6	15"	Hyi	2	double star
ST106	Algol	Beta	03 08.2	+41.0	2.2	*	Per	22	variable star
ST107	Alpha	ADS 2402	03 12.1	-29.0	4	5"	For	2	double star
ST108	h3556		03 12.4	-44.4	6	3.5"	Eri	2	double star
ST109	Σ362		03 16.3	+60 02	8.5	7"	Cam	3	double star equal magnitude
ST110	Σ369		03 17.2	+40 29	6.7	3"	Per	5	colored double star
ST111	ADS2446		03 17.7	+38.6	7.8	0.9"	Per	4	double star challenge

Number	Name	Other	RA	Dec	Mag	Sep	Con	Code	
ST112	Zeta		03 18.2	-62.5	5.2	5"	Ret	2	double star
ST113	Tau4	ADS 2472	03 19.5	-21.8	3.7	*	Eri	21	star
ST114	Toms Topaz	SAO 75871	03 20.3	+29.0	4.5	9°	Ari	21	star
ST115	Mirfak	Alpha	03 24.3	+49 52	1.8	*	Per	21	star
ST116	Y		03 27.7	+44.2	8.1	*	Per	22	variable star
ST117	Σ394		03 28.0	+20 27	7.1	7"	Ari	2	double star
ST118	Σ385	ADS 2544	03 29.1	+59.9	4.2	2.4"	Cam	2	double star
ST119	Σ389		03 30.1	+59 21	6.5	2.7"	Cam	2	double star
ST120	Sigma		03 30.6	+48.0	4.4	*	Per	21	star
ST121	Σ401		03 31.3	+27 34	6.4	11"	Tau	3	double star equal magnitude
ST122	Epsilon		03 32.9	-09.5	3.7	*	Eri	21	star
ST123	Σ400	ADS 2612	03 35.0	+60.0	6.8	1.4"	Cam	2	double star
ST124	OΣ36	ADS 2650	03 40.0	+63.9	6.8	46"	Cam	2	double star
ST125	U1		03 41.6	+62.6	8.1		Cam	22	variable star
ST126	Omicron	ADS 2726	03 44.3	+32.3	3.8		Per	21	star
ST127	Pi	26	03 46.1	-12.1	4.4	*	Eri	1	red variable star
ST128	Gamma		03 47.2	-74.2	3.2	*	Hya	21	star
ST129	Σ52	30	03 48.3	+11.2	5	9"	Tau	2	double star
ST130	F	Δ 16	03 48.6	-37 37	4.9	8"	Eri	3	double star equal magnitude
ST131	BE	SAO 12916	03 49.5	+65.5	4.5	*	Cam	21	star
ST132	Atik	Zeta	03 54.1	+31.9	2.9	*	Per	21	star
ST133	32	ADS 2850	03 54.3	-03.0	5	7"	Eri	5	colored double star
ST134	Epsilon		03 57.9	+40 01	2.9	9"	Per	9	double star magnitude contrast
ST135	Zaurak	Gamma	03 58.0	-13.5	3	*	Eri	21	star
ST136	Lambda	35	04 00.7	+12.5	3.3	*	Tau	22	variable star
ST137	OΣ531	ADS 2995	04 07.6	+38.1	7.4	1.4"	Per	4	double star challenge
ST138	Σ485	SZ	04 07.8	+62 20	7	90"	Cam	2	double star
ST139	Omicron2	40	04 15.2	-07.7	4.5	83"	Eri	8	triple star challenge
ST140	Epsilon		04 16.5	-59.3	4.4	*	Ret	21	star
ST141	Theta	Rumker 3	04 17.7	-63.3	6.2	4"	Ret	2	double star
ST142	Phi	ADS 3137	04 20.4	+27.4	5	52"	Tau	2	double star
ST143	T		04 22.0	+19 32	8.4	Stellar	Tau	22	variable star
ST144	Σ528	Chi	04 22.6	+25.6	5.5	19.4"	Tau	2	double star
ST145	ADS3169		04 22.7	+15.1	7.3	1.4"	Tau	4	double star challenge
ST146	43	Upsilon3	04 24.0	-34.0	4	*	Eri	1	red variable star
ST147	β 184		04 27.9	-21 30	7.3	1.7"	Eri	4	double star challenge

Number	Name	Other	RA	Dec	Mag	Sep	Con	Code	
ST148	Σ552		04 31.4	+40 01	7	9"	Per	3	double star equal magnitude
ST149	1		04 32.0	+53 55	5.4	10"	Cam	5	colored double star
ST150	Σ559		04 33.5	+18 01	6.9	3"	Tau	3	double star equal magnitude
ST151	46	ADS 3305	04 33.9	-06.7	5.7	4'	Eri	2	double star
ST152	Aldebaran	Alpha	04 35.9	+16.5	0.9	30"	Tau	5	colored double star
ST153	Nu	48	04 36.3	-03.4	3.9	11°	Eri	21	star
ST154	53		04 38.2	-14.3	3.9	*	Eri	21	star
ST155	Σ572		04 38.5	+26 56	7.3	4"	Tau	3	double star equal magnitude
ST156	54		04 40.4	-19.7	4.3	*	Eri	1	red variable star
ST157	R		04 40.5	-38.2	6.7	*	Cae	22	variable star
ST158	Σ590	55	04 43.6	-08 48	6.7	9"	Eri	3	double star equal magnitude
ST159	Iota	Dunlop 18	04 50.9	-53.5	5.6	12"	Pic	2	double star
ST160	ST	RV	04 51.2	+68 10	9.2	Stellar	Cam	1	red variable star
ST161	Pi4	3	04 51.2	+05.6	3.7	*	Ori	21	star
ST162	TT		04 51.6	+28.5	8	*	Tau	22	variable star
ST163	Pi5	8	04 54.2	+02.4	3.7	*	Ori	21	star
ST164	Omicron2	9	04 56.4	+13.5	4.1	*	Ori	21	star
ST165	Iota		04 57.0	+33.2	2.7	*	Aur	21	star
ST166	Pi6	10	04 58.5	+01.7	4.5	*	Ori	21	star
ST167	Omega	ADS 3572	04 59.3	+37.9	5	5.4"	Aur	2	double star
ST168	Hinds Crimson Star	R	04 59.6	-14.8	5.9	*	Lep	22	variable star
ST169	Σ627		05 00.6	+03 36	6.6	21"	Ori	3	double star equal magnitude
ST170	Σ631	ADS 3606	05 00.7	-13.5	7.5	5.5"	Lep	2	double star
ST171	Σ630	ADS 3623	05 02.0	+01.6	6.5	15"	Ori	2	double star
ST172	Epsilon		05 02.0	+43 49	2.9	Stellar	Aur	22	variable star
ST173	Zeta	8	05 02.5	+41.1	3.8	*	Aur	21	star
ST174	W		05 05.4	+01.2	8.6	*	Ori	22	variable star
ST175	Epsilon		05 05.5	-22.4	3.2	*	Lep	21	star
ST176	Eta	10	05 06.5	+41.2	3.2	*	Aur	21	star
ST177	OΣ98	14	05 07.9	+08 29	5.9	0.7"	Ori	4	double star challenge
ST178	TX		05 09.1	+39.0	8.5	*	Aur	22	variable star
ST179	SY		05 09.8	-05.6	9	*	Eri	22	variable star
ST180	Σ644		05 10.4	+37 17	6.8	2"	Aur	4	double star challenge
ST181	Σ655	Iota	05 12.3	-11.9	4.5	13"	Lep	2	double star
ST182	Rho		05 13.3	+02 52	4.5	7"	Ori	5	colored double star

Number	Name	Other	RA	Dec	Mag	Sep	Con	Code	
ST183	Rigel	Beta ORI	05 14.5	-08.2	0	9.4"	Ori	9	double star magnitude contrast
ST184	Σ653	14	05 15.4	+32.7	5.1	11"	Aur	6	triple star
ST185	Capella	Alpha	05 16.7	+46 00	0.1	*	Aur	21	star
ST186	S 476		05 19.3	-18 30	6.2	39"	Lep	3	double star equal magnitude
ST187	h3750		05 20.5	-21 14	4.7	4"	Lep	9	double star magnitude contrast
ST188	UV		05 21.8	+32.5	7.4	*	Aur	22	variable star
ST189	ADS3954	ADS 3954	05 21.8	-24.8	5.5	3.2"	Lep	2	double star
ST190	Σ696	ADS 3962	05 22.8	+03.6	5	32"	Ori	2	double star
ST191	Σ701	ADS 3978	05 23.3	-08.4	6	6"	Ori	2	double star
ST192	Eta		05 24.5	-02 24	3.4	1.5"	Ori	4	double star challenge
ST193	Sigma	ADS 3984	05 24.7	+37.4	5	9"	Aur	2	double star
ST194	Theta	Dunlop 20	05 24.8	-52.3	6.8	38"	Pic	2	double star
ST195	Bellatrix	Gamma	05 25.1	+06.3	1.6	*	Ori	21	star
ST196	Σ698	ADS 4000	05 25.2	+34.9	6.6	31"	Aur	2	double star
ST197	Σ716	118	05 29.3	+25 09	5.8	5"	Tau	2	double star
ST198	Σ725	31	05 29.7	-01.1	4.7	*	Ori	21	star
ST199	TL9	KBC Group	05 30.0	+17.0	5	5°	Tau	0	asterism
ST200	Delta	ADS 4134	05 32.0	-00.3	2.2	53"	Ori	2	double star
ST201	119	CE	05 32.2	+18.6	4.7	*	Tau	21	star
ST202	Σ718		05 32.4	+49 24	7.5	8"	Aur	3	double star equal magnitude
ST203	RT		05 33.2	+07.2	8	*	Ori	22	variable star
ST204	Σ747	ADS 4182	05 35.0	-06.0	4.8	36"	Ori	2	double star
ST205	Lambda		05 35.1	+09 56	3.4	4"	Ori	9	double star magnitude contrast
ST206	Trapezium		05 35.3	-05 23	5.1	13"	Ori	7	quadruple star
ST207	Σ752	Iota	05 35.4	-05 55	2.9	11"	Ori	9	double star magnitude contrast
ST208	Alnilam	Epsilon	05 36.2	-01.2	1.7	*	Ori	21	star
ST209	Phi2		05 36.9	+09.3	4	*	Ori	21	star
ST210	Zeta	123	05 37.6	+21.1	3	*	Tau	21	star
ST211	Sigma		05 38.7	-02 36	3.7	11"	Ori	7	quadruple star
ST212	Phact	Alpha	05 39.6	-34.1	2.6	*	Col	21	star
ST213	Alnitak	Zeta	05 40.8	-01.9	2	2.4"	Ori	9	double star magnitude contrast
ST214	U2		05 42.2	+62.5	7.7	*	Cam	22	variable star
ST215	Gamma	ADS 4334	05 44.5	-22.5	3.7	97"	Lep	2	double star
ST216	Y		05 45.7	+20.7	7.1	*	Tau	22	variable star

Number	Name	Other	RA	Dec	Mag	Sep	Con	Code	
ST217	Mu	SAO 196149	05 46.0	-32.3	5.2	*	Col	21	star
ST218	Saiph	Kappa	05 47.8	-09.7	2	*	Ori	21	star
ST219	Σ795	52	05 48.0	+06 27	6.1	1.3"	Ori	4	double star challenge
ST220	Beta	Wazn	05 51.0	-35.8	3.1	*	Col	21	star
ST221	Delta		05 51.3	-20.9	3.8	*	Lep	21	star
ST222	Nu		05 51.5	+39.1	4	30"	Aur	21	star
ST223	Σ817		05 54.9	+07 02	8.8	19"	Ori	3	double star equal magnitude
ST224	Betelgeuse	Alpha	05 55.2	+07 24	0.5	Stellar	Ori	21	star
ST225	U		05 55.8	+20.2	5.3	*	Ori	22	variable star
ST226	Theta		05 59.7	+37 13	2.6	3.5"	Aur	9	double star magnitude contrast
ST227	Pi		05 59.9	+45.9	4.3	1°	Aur	1	red variable star
ST228	Δ23		06 04.8	-48 27	7	2.7"	Pup	3	double star equal magnitude
ST229	Σ855		06 09.0	+02 30	6	30"	Ori	2	double star
ST230	TU		06 10.9	+26.0	7.5	*	Gem	22	variable star
ST231	Σ845	41	06 11.7	+48 42	6.1	8"	Aur	2	double star
ST232	SS		06 13.4	+47.0	10	*	Aur	22	variable star
ST233	Gamma		06 14.9	-06.3	4	8°	Mon	21	star
ST234	Propus	Eta	06 14.9	+22.5	3.3	*	Gem	21	star
ST235	Σ872	ADS 4849	06 15.6	+36.2	6.9	11"	Aur	2	double star
ST236	KS		06 19.7	-05.3	9.5	*	Mon	22	variable star
ST237	Zeta	Furud	06 20.3	-30.1	3	8.5°	Cma	21	star
ST238	V		06 22.7	-02.2	6	*	Mon	22	variable star
ST239	Mirzam	Beta	06 22.7	-18.0	2	*	Cma	21	star
ST240	Mu		06 23.0	+22.5	2.9	*	Gem	21	star
ST241	8		06 23.8	+04 36	4.3	13"	Mon	5	colored double star
ST242	Canopus	Alpha	06 24.0	-52 42	-0.7	*	Car	21	star
ST243	BL	BL	06 25.5	+14.7	8.5	*	Ori	22	variable star
ST244	15		06 27.8	+20 47	6.6	27"	Gem	2	double star
ST245	Beta		06 28.8	-07 02	3.8	3"	Mon	6	triple star
ST246	ADS5150		06 31.8	+38.9	11.5	4.5"	Aur	2	double star
ST247	Σ924	20	06 32.3	+17.8	6.3	20"	Gem	5	colored double star
ST248	ADS5188		06 34.3	+38.1	6.7	43"	Aur	2	double star
ST249	CR		06 34.4	+16.1	8.5	*	Gem	22	variable star
ST250	Σ928	ADS 5191	06 34.7	+38.4	7.6	3.5"	Aur	2	double star
ST251	ADS5201		06 35.1	+37.1	7.4	2.6"	Aur	2	double star
ST252	Σ929	ADS 5208	06 35.4	+37.7	7.4	6"	Aur	2	double star
ST253	Σ939		06 35.9	+05.3	8.3	30"	Mon	2	double star
ST254	ADS5221		06 36.2	+38.0	8.5	1.3"	Aur	4	double star challenge

Number	Name	Other	RA	Dec	Mag	Sep	Con	Code	
ST255	Nu1		06 36.4	-18.7	6	17.5"	Cma	5	colored double star
ST256	UU		06 36.5	+38.5	5.1	*	Aur	22	variable star
ST257	ADS5240		06 36.9	+38.2	9.7	2.2"	Aur	2	double star
ST258	ADS5245		06 37.3	+38.4	8.8	10"	Aur	2	double star
ST259	South529		06 37.6	+12.2	7.6	70"	Gem	2	double star
ST260	Innes5		06 38.0	-61.5	6.4	2.4"	Pic	2	double star
ST261	ADS5265		06 38.4	+38.8	9.6	4.6"	Aur	2	double star
ST262	Innes1156	ADS 5311	06 39.1	-29.1	8	0.7"	Cma	4	double star challenge
ST263	SA0172106		06 39.5	-30.0	7.8	2.5°	Cma	1	red variable star
ST264	Σ953		06 41.2	+08 59	7.1	7"	Mon	2	double star
ST265	VW		06 42.2	+31.5	8.7	*	Gem	22	variable star
ST266	Sirius	Alpha	06 45.1	-16.7	-1	9"	Cma	9	double star magnitude contrast
ST267	Σ948	12	06 46.2	+59 27	4.9	2"	Lyn	8	triple star challenge
ST268	Σ958		06 48.2	+55 42	5.5	5"	Lyn	3	double star equal magnitude
ST269	Kappa	13	06 49.8	-32.5	4	*	Cma	21	star
ST270	Σ963	14	06 53.1	+59.5	5.7	0.4"	Lyn	4	double star challenge
ST271	GY		06 53.2	-04.6	9.4	*	Mon	22	variable star
ST272	Σ987		06 54.1	-05 51	7.1	1.3"	Mon	4	double star challenge
ST273	Omicron1	16	06 54.1	-24.2	3.9	*	Cma	21	star
ST274	Theta	14	06 54.2	-12.0	4.1	*	Cma	21	star
ST275	38		06 54.6	+13 11	4.7	7"	Gem	5	colored double star
ST276	Σ997	Mu	06 56.1	-14 02	5.3	2.8"	Cma	9	double star magnitude contrast
ST277	BG		06 56.4	+07.1	9.2	*	Mon	22	variable star
ST278	OΣ80		06 58.1	+14.2	7.3	2'	Gem	0	asterism
ST279	RV		06 58.4	+06.2	7	*	Mon	22	variable star
ST280	Epsilon	21	06 58.6	-29.0	1.5	7.5"	Cma	2	double star
ST281	Sigma	22	07 01.7	-27.9	3.5	*	Cma	21	star
ST282	Omicron2	24	07 03.0	-23.8	3	*	Cma	21	star
ST283	Dunlop38		07 04.0	-43.6	5.6	20.5"	Pup	2	double star
ST284	Mekbuda	Zeta	07 04.1	+20.6	3.7	*	Gem	22	variable star
ST285	Σ1009		07 05.7	+52 45	6.9	4.1"	Lyn	3	double star equal magnitude
ST286	R		07 07.4	+22.7	6	*	Gem	22	variable star
ST287	W	RV	07 08.1	-11 55	6.4	Stellar	CMA	1	red variable star
ST288	Gamma	Dunlop 42	07 08.8	-70.5	4	13.6"	Vol	2	double star
ST289	Tau	ADS 5846	07 11.1	+30.2	4.4	1.9"	Gem	2	double star
ST290	Σ1035		07 12.0	+22 17	8.2	4"	Gem	3	double star equal magnitude
ST291	Σ1037	ADS 5871	07 12.8	+27.2	7.2	1.3"	Gem	4	double star challenge

Number	Name	Other	RA	Dec	Mag	Sep	Con	Code	
ST292	Omega	28	07 14.8	-26.8	3.9	*	Cma	21	star
ST293	h3945		07 16.6	-23 19	4.5	27"	CMa	5	colored double star
ST294	Tau	h 3948	07 18.7	-24 57	4.4	15"	CMa	6	triple star
ST295	Delta	55	07 20.1	+21 59	3.5	6"	Gem	9	double star magnitude contrast
ST296	Σ 1062	19	07 22.9	+55 17	5.6	15"	Lyn	6	triple star
ST297	Gamma	4	07 28.2	+08.9	4.3	*	Cmi	21	star
ST298	Sigma		07 29.2	-43.3	3.3	22"	Pup	2	double star
ST299	Σ 1093	ADS 6117	07 30.3	+50.0	8.8	0.8"	Lyn	4	double star challenge
ST300	n	"HN19, h269"	07 34.3	-23 28	5.1	10"	Pup	3	double star equal magnitude
ST301	Castor	Alpha	07 34.6	+31.9	2	1.8"	Gem	4	double star challenge
ST302	Upsilon	69	07 35.9	+26.9	4.1	2.5°	Gem	1	red variable star
ST303	Σ 1121		07 36.6	-14 29	7.9	7"	Pup	3	double star equal magnitude
ST304	K		07 38.8	-26 48	3.8	10"	Pup	3	double star equal magnitude
ST305	Procyon	Alpha	07 39.3	+05 14	0.4	Stellar	CMi	21	star
ST306	O Σ 179	Kappa	07 44.4	+24 23	3.7	7"	Gem	9	double star magnitude contrast
ST307	Σ 1138	2	07 45.5	-14 41	6.1	17"	Pup	3	double star equal magnitude
ST308	Σ 1127		07 47.0	+64 03	7	5"	Cam	6	triple star
ST309	Σ 1149		07 49.4	+03 13	7.9	22"	Cmi	2	double star
ST310	U	V	07 55.1	+22 00	8.2	Stellar	Gem	22	variable star
ST311	Chi		07 56.8	-53.0	3.5	4°	Car	21	star
ST312	Dunlop59		07 59.2	-50.0	6.5	16"	Pup	2	double star
ST313	S-h86		08 02.5	+63.1	6	49"	Cam	2	double star
ST314	Naos	Zeta	08 03.6	-40.0	2.3	4°	Pup	21	star
ST315	RT		08 05.4	-38.8	8.5	*	Pup	22	variable star
ST316	RU		08 07.5	-22.9	8.9	*	Pup	22	variable star
ST317	Epsilon	Rumker 7	08 07.9	-68.6	4.4	6"	Vol	2	double star
ST318	Gamma	Dunlop 65	08 09.5	-47.3	1.9	41"	Vel	2	double star
ST319	Zeta		08 12.2	+17 39	4.7	0.6"	Cnc	8	triple star challenge
ST320	c	Rumker 8	08 15.3	-62.9	5.3	4"	Car	2	double star
ST321	Beta	17	08 16.5	+09.2	3.5	*	Cnc	21	star
ST322	R		08 16.6	+11.7	6.1	*	Cnc	22	variable star
ST323	Kappa		08 19.8	-71.5	5.4	65"	Vol	2	double star
ST324	AC		08 22.7	-15.9	8.9	*	Pup	22	variable star
ST325	31		08 22.8	+43.2	4.3	15°	Lyn	21	star
ST326	Beta		08 25.7	-66.1	3.8	6°	Vol	21	star

Number	Name	Other	RA	Dec	Mag	Sep	Con	Code	
ST327	h4903		08 26.3	-39.1	6.5	8"	Pup	2	double star
ST328	Σ1224	24	08 26.7	+24 32	7.1	6"	Cnc	2	double star
ST329	Σ1223	Phi	08 26.7	+26 56	6.3	5"	Cnc	3	double star equal magnitude
ST330	h4104		08 29.1	-47.9	5.5	3.6"	Vel	2	double star
ST331	Δ70		08 29.5	-44 44	5	5"	Vel	2	double star
ST332	h4107		08 31.4	-39 04	6.4	4"	Vel	6	triple star
ST333	Σ1245		08 35.8	+06 37	6	10"	Cnc	2	double star
ST334	Sigma	5 HYA	08 38.8	+03.3	4.4	*	Hya	21	star
ST335	h4128		08 39.2	-60.3	6.9	1.4"	Car	4	double star challenge
ST336	Σ1254		08 40.4	+19 40	6.4	21"	Cnc	7	quadruple star
ST337	Alpha		08 43.6	-33.2	3.7	*	Pyx	21	star
ST338	Delta	Innes 10	08 44.7	-54.7	2.1	2.6"	Vel	2	double star
ST339	Σ1270	ADS 6977	08 45.3	-02.6	6.4	5"	Hya	2	double star
ST340	Σ1268	Iota	08 46.7	+28 46	4	30"	Cnc	5	colored double star
ST341	Epsilon		08 46.8	+06 25	3.4	3"	Hyd	9	double star magnitude contrast
ST342	Σ1282		08 50.8	+35 03	7.5	4"	Lyn	3	double star equal magnitude
ST343	X		08 55.4	+17.2	5.6	*	Cnc	22	variable star
ST344	Σ1298	66	09 01.4	+32 15	5.9	5"	Cnc	2	double star
ST345	Rho		09 02.5	+67.6	4.8	1°	Uma	21	star
ST346	Σ1311		09 07.5	+22 59	6.9	8"	Cnc	3	double star equal magnitude
ST347	Suhail	Lambda	09 08.0	-43 26	2.2	Stellar	Vel	21	star
ST348	Sigma2		09 10.4	+67 08	4.8	4"	Uma	9	double star magnitude contrast
ST349	a		09 11.0	-59.0	3.4	50'	Car	21	star
ST350	h4188		09 12.5	-43.6	6.7	2.7'	Vel	2	double star
ST351	h4191		09 14.4	-43 13	5.2	6"	Vel	9	double star magnitude contrast
ST352	Σ1321		09 14.9	+52 42	8.1	18"	Uma	3	double star equal magnitude
ST353	g		09 16.2	-57.5	4.3	5'	Car	21	star
ST354	RT		09 18.4	+51.4	8.6	*	Uma	22	variable star
ST355	Σ1334	38	09 18.8	+36 48	3.9	3"	Lyn	4	double star challenge
ST356	Σ1338		09 21.0	+38 11	6.6	1"	Lyn	4	double star challenge
ST357	Alpha	40	09 21.1	+34.4	3.1	*	Lyn	21	star
ST358	Kappa		09 22.1	-55.0	2.5	*	Vel	21	star
ST359	Σ1347		09 23.3	+03 30	7.2	21"	Hya	2	double star
ST360	Kappa	ADS 7351	09 24.7	+26.2	4.5	2.1"	Leo	6	triple star

Number	Name	Other	RA	Dec	Mag	Sep	Con	Code	
ST361	Σ1355		09 27.3	+06 14	7.5	2.3"	Hya	3	double star equal magnitude
ST362	Alphard	Alpha	09 27.6	-08 40	2	Stellar	Hya	21	star
ST363	Σ1356	Omega	09 28.5	+09.1	5.9	0.5"	Leo	4	double star challenge
ST364	Dunlop76		09 28.6	-45.5	7.8	61"	Vel	2	double star
ST365	Σ1360		09 30.6	+10 35	8.3	14"	Leo	3	double star equal magnitude
ST366	Zeta		09 30.8	-31 53	5.8	8"	Ant	2	double star
ST367	N		09 31.2	-57.0	3.1	*	Vel	21	star
ST368	Σ1351	23	09 31.5	+63 03	3.8	23"	Uma	9	double star magnitude contrast
ST369	Alterf	Lambda	09 31.7	+23.0	4.3	*	Leo	21	star
ST370	R		09 32.2	-62.8	3.8	*	Car	22	variable star
ST371	Σ1369	ADS 7438	09 35.4	+40.0	6.5	25"	Lyn	2	double star
ST372	Iota		09 39.9	-01.1	3.9	*	Hya	21	star
ST373	Upsilon	Rumker 11	09 47.1	-65.1	3.1	5"	Car	2	double star
ST374	R	RV	09 47.6	+11 26	4.4	Stellar	Leo	1	red variable star
ST375	W		09 51.0	-02.0	9	*	Sex	22	variable star
ST376	Y		09 51.1	-23.0	8.3	*	Hya	22	variable star
ST377	Rasalas	Mu	09 52.8	+26.0	3.9	*	Leo	21	star
ST378	h4262	ADS 7571	09 54.5	-12.9	8.7	8"	Hya	2	double star
ST379	Regulus	Alpha	10 08.4	+11 58	1.4	Stellar	Leo	21	star
ST380	S		10 09.4	-61.6	4.5	*	Car	22	variable star
ST381	ADS7704		10 16.3	+17.7	7.2	1.4"	Leo	4	double star challenge
ST382	Adhafera	Zeta	10 16.7	+23.4	3.4	5.5'	Leo	2	double star
ST383	q		10 17.1	-61.3	3.4	*	Car	21	star
ST384	h4306		10 19.1	-64.7	5.6	2.1"	Car	2	double star
ST385	Algieba	Gamma	10 20.0	+19.8	2.5	4.4"	Leo	2	double star
ST386	Tania Australis	Mu	10 22.3	+41.5	3	*	Uma	21	star
ST387	Mu	42	10 26.1	-16.8	3.8	*	Hya	21	star
ST388	Alpha		10 27.2	-31.1	4.3	*	Ant	21	star
ST389	45		10 27.6	+09.8	6	3.8"	Leo	2	double star
ST390	Delta	HN 50	10 29.6	-30 36	5.7	11"	Ant	9	double star magnitude contrast
ST391	p		10 32.0	-61.7	3.3	*	Car	21	star
ST392	Rho	47	10 32.8	+09.3	3.9	*	Leo	21	star
ST393	49		10 35.0	+08 39	5.7	2"	Leo	4	double star challenge
ST394	U		10 35.2	-39.6	8.1	*	Ant	22	variable star
ST395	Gamma		10 35.5	-78.6	4.1	*	Cha	21	star
ST396	U		10 37.6	-13.4	7	*	Hya	22	variable star
ST397	Dunlop95	x	10 39.3	-55.6	4.3	52"	Vel	2	double star

Number	Name	Other	RA	Dec	Mag	Sep	Con	Code	
ST398	Σ1466	35	10 43.4	+04 44	6.3	7"	Sex	2	double star
ST399	R		10 44.6	+68.8	7.5	*	Uma	22	variable star
ST400	VY		10 45.1	+67.4	5.9	*	Uma	22	variable star
ST401	Delta		10 45.8	-80.5	4.5	4.5'	Cha	2	double star
ST402	Σ1476	40	10 49.3	-04 01	6.9	2.5"	Sex	2	double star
ST403	Nu		10 49.6	-16.2	3.1	*	Hya	21	star
ST404	54	ADS 7979	10 55.6	+24.8	4.5	6.8"	Leo	2	double star
ST405	SA0251342		11 17.5	-63.5	7	7"	Car	9	double star magnitude contrast
ST406	Xi	ADS 8119	11 18.2	+31.5	4.5	1.3"	Uma	4	double star challenge
ST407	Alula Borealis	Nu	11 18.5	+33.1	3.5	7"	Uma	2	double star
ST408	Σ1529		11 19.4	-01 38	7	10"	Leo	2	double star
ST409	h4432		11 23.4	-65.0	5.1	2.3"	Mus	2	double star
ST410	Iota	ADS 8148	11 23.9	+10.5	4	1.3"	Leo	4	double star challenge
ST411	Σ1540	83	11 26.8	+03 00	6.2	29"	Leo	6	triple star
ST412	Tau	84	11 27.9	+02.9	5.5	1.5'	Leo	2	double star
ST413	Giausar	Lambda	11 31.4	+69.3	3.8	20'	Dra	1	red variable star
ST414	88	x	11 31.8	+14 21	6.4	16"	Leo	2	double star
ST415	N		11 32.3	-29 16	5.8	9"	Hyd	3	double star equal magnitude
ST416	Innes78		11 33.6	-40.6	6	1"	Cen	4	double star challenge
ST417	Σ1552		11 34.7	+16 48	6	3"	Leo	6	triple star
ST418	Nu		11 45.9	+06.5	4	*	Vir	21	star
ST419	Denebola	Beta	11 49.1	+14 34	2.1	Stellar	Leo	21	star
ST420	Beta		11 52.9	-33.9	4.7	0.9"	Hya	5	colored double star
ST421	OΣ112		11 54.6	+19.4	8.4	73"	Leo	2	double star
ST422	Σ1579	65	11 55.1	+46 29	6.7	4"	Uma	2	double star
ST423	Epsilon	h4486	11 59.6	-78.2	5.4	0.9"	Cha	5	colored double star
ST424	Σ1593		12 03.5	-02 26	8.7	1.3"	Vir	4	double star challenge
ST425	Zeta	2	12 04.3	+21.5	6	3.6"	Com	2	double star
ST426	Delta		12 08.4	-50.7	2.6	4.5'	Cen	2	double star
ST427	Σ1604		12 09.5	-11 51	6.6	10"	Crv	6	triple star
ST428	Epsilon		12 10.1	-22.6	3	*	Crv	21	star
ST429	Rumker14		12 14.0	-45.7	5.6	2.9"	Cen	2	double star
ST430	Delta		12 15.1	-58.7	2.8	*	Cru	21	star
ST431	2	ADS 8489	12 16.1	+40.7	6	11.5"	Cvn	5	colored double star
ST432	Epsilon		12 17.6	-68.0	4.1	*	Mus	1	red variable star
ST433	Σ1627		12 18.1	-03 56	6.6	20"	Vir	3	double star equal magnitude
ST434	R		12 19.6	-19.3	6.7	*	Crv	22	variable star
ST435	Σ1633		12 20.6	+27 03	6.3	9"	Com	3	double star equal magnitude

Number	Name	Other	RA	Dec	Mag	Sep	Con	Code	
ST436	Epsilon		12 21.4	-60.4	3.6	*	Cru	21	star
ST437	M40	Winnecke 4	12 22.4	+58 05	9	50"	UMa	2	double star
ST438	17	ADS 8531	12 22.5	+05.3	6.5	21"	Vir	2	double star
ST439	Σ1639	ADS 8539	12 24.4	+25.6	6.8	1.6"	Com	4	double star challenge
ST440	S		12 24.6	-49.4	9.2	*	Cen	22	variable star
ST441	SS	RV	12 25.3	+00 48	6	Stellar	Vir	1	red variable star
ST442	Acrux	Alpha	12 26.6	-63.1	1	4.4"	Cru	2	double star
ST443	3C273		12 29.1	+02.0	12.8	*	Vir	0	asterism
ST444	Algorab	Delta	12 29.9	-16.5	3	24"	Crv	2	double star
ST445	Gacrux	Gamma	12 31.2	-57.1	1.6	10"	Cru	2	double star
ST446	Σ1649	ADS 8585	12 31.6	-11.1	8	15"	Vir	2	double star
ST447	24		12 35.1	+18 23	5	20"	CVn	5	colored double star
ST448	Alpha		12 37.2	-69.1	2.7	*	Mus	21	star
ST449	ADS8612		12 37.7	-27.1	5.5	1.3"	Hya	4	double star challenge
ST450	Σ1669		12 41.3	-13 01	5.3	5"	Crv	3	double star equal magnitude
ST451	Gamma	h4539	12 41.5	-49.0	2.2	1"	Cen	4	double star challenge
ST452	Porrima	Gamma	12 41.7	-01.4	3.5	3"	Vir	2	double star
ST453	Y	RV	12 45.1	+45 26	7.4	Stellar	CVn	1	red variable star
ST454	Iota	h4547	12 45.6	-61.0	4.7	27	Cru	2	double star
ST455	Beta		12 46.3	-68.1	3.7	1.4	Mus	4	double star challenge
ST456	Mimosa	Beta	12 47.7	-59.7	1.3	*	Cru	21	star
ST457	Σ1694	32	12 49.2	+83 25	5.3	22"	Cam	3	double star equal magnitude
ST458	Σ1687	35	12 53.3	+21 14	5.1	29"	Com	9	double star magnitude contrast
ST459	Mu	Dunlop 126	12 54.6	-57.2	4.3	35"	Cru	2	double star
ST460	Delta		12 55.6	+03.4	3.4	*	Vir	1	red variable star
ST461	Cor Caroli	Alpha	12 56.0	+38.3	3	19"	Cvn	2	double star
ST462	RY		12 56.4	+66.0	6.8	*	Dra	22	variable star
ST463	Σ1699		12 58.7	+27 28	8.8	1.5"	Com	4	double star challenge
ST464	Delta		13 02.3	-71.5	3.6	8'	Mus	21	star
ST465	Theta	Rumker 16	13 08.1	-65.3	5.7	5.3"	Mus	2	double star
ST466	Σ1724	"51, Theta"	13 09.9	-05 32	4.4	7"	Vir	8	triple star challenge
ST467	Alpha		13 10.0	+17 32	5	0.5"	Com	4	double star challenge
ST468	54		13 13.4	-18 50	6.8	5"	Vir	2	double star
ST469	J	Dunlop 133	13 22.6	-61.0	4.7	1'	Cen	2	double star

Number	Name	Other	RA	Dec	Mag	Sep	Con	Code	
ST470	Mizar	Zeta	13 23.9	+54 56	2.3	14"	Uma	2	double star
ST471	Spica	Alpha	13 25.2	-11.2	1	*	Vir	21	star
ST472	$\theta^{\Sigma}123$		13 27.1	+64 43	6.7	69"	Dra	5	colored double star
ST473	R	V	13 29.7	-23 17	4	Stellar	Hyd	22	variable star
ST474	$\Sigma 1755$	ADS 8934	13 32.3	+36.8	7	4.4"	Cvn	2	double star
ST475	S		13 33.0	-07.2	6	*	Vir	22	variable star
ST476	25	ADS 8974	13 37.5	+36.3	5	1.8"	Cvn	9	double star magnitude contrast
ST477	$\Sigma 1763$	ADS 8972	13 37.6	-07.9	7.9	2.8"	Vir	2	double star
ST478	Epsilon		13 39.9	-53.5	2.3	*	Cen	21	star
ST479	$\Sigma 1772$	1	13 40.7	+19 57	5.7	5"	Boo	9	double star magnitude contrast
ST480	Dunlop141		13 41.7	-54.6	5.3	5.3"	Cen	2	double star
ST481	T		13 41.8	-33.6	5.5	*	Cen	22	variable star
ST482	Alkaid	Eta	13 47.5	+49.3	1.9	*	Uma	21	star
ST483	$\Sigma 1785$	ADS 9031	13 49.1	+27.0	7.6	3.4"	Boo	2	double star
ST484	2		13 49.4	-34.5	4.2	*	Cen	21	star
ST485	Upsilon		13 49.5	+15.8	4.1	*	Boo	21	star
ST486	3	k	13 51.8	-33.0	4.5	8"	Cen	2	double star
ST487	Zeta		13 55.5	-47.3	2.6	5°	Cen	21	star
ST488	Hadar	Beta	14 03.8	-60.4	0.6	*	Cen	21	star
ST489	Pi		14 06.4	-26.7	3.3	*	Hya	21	star
ST490	Kappa		14 12.9	-10.3	4.2	*	Vir	21	star
ST491	Kappa		14 13.5	+51 47	4.4	13"	Boo	5	colored double star
ST492	$\Sigma 1819$		14 15.3	+03 08	7.8	0.8"	Vir	4	double star challenge
ST493	Arcturus	Alpha	14 15.7	+19 11	0	Stellar	Boo	21	star
ST494	Iota	ADS 9198	14 16.2	+51.4	4.9	39"	Boo	2	double star
ST495	R		14 16.6	-59.9	5.3	*	Cen	22	variable star
ST496	$\Sigma 1834$	ADS 9229	14 20.3	+48.5	8.1	1.3"	Boo	4	double star challenge
ST497	$\Sigma 1833$		14 22.6	-07 46	7.6	6"	Vir	3	double star equal magnitude
ST498	Dunlop159		14 22.6	-58.5	5	9"	Cen	5	colored double star
ST499	$\Sigma 1835$		14 23.4	+08 26	5.1	6"	Boo	2	double star
ST500	SHJ 179		14 25.5	-19 58	6.4	35"	Lib	2	double star
ST501	5	ADS 9286	14 27.5	+75.7	4.3	*	Umi	21	star
ST502	Proxima		14 29.9	-62.7	10.7	*	Cen	22	variable star
ST503	Rho	ADS 9296	14 31.8	+30.4	3.6	*	Boo	21	star
ST504	h4690		14 37.3	-46 08	5.4	19"	Lup	9	double star magnitude contrast
ST505	Rigel Kentaurus	Alpha	14 39.6	-60 50	0	20"	Cen	2	double star
ST506	Pi	ADS 9338	14 40.7	+16.4	5	5.6"	Boo	2	double star
ST507	$\Sigma 1864$	pi	14 40.7	+16 25	4.9	6"	Boo	2	double star

Number	Name	Other	RA	Dec	Mag	Sep	Con	Code	
ST508	Zeta		14 41.1	+13 44	3.8	1"	Boo	4	double star challenge
ST509	Alpha		14 41.9	-47.4	2.3	*	Lup	21	star
ST510	q		14 42.0	-37.8	4	*	Cen	21	star
ST511	Alpha	Dunlop 166	14 42.5	-65.0	3.2	16"	Cir	2	double star
ST512	c1		14 43.7	-35.2	4	17'	Cen	21	star
ST513	Izar	Epsilon	14 45.0	+27 04	2.4	3"	Boo	5	colored double star
ST514	Dunlop	Dunlop 169	14 45.2	-55.6	6.2	68"	Cir	2	double star
ST515	54	H 97	14 46.0	-25 26	5.2	8"	Hya	2	double star
ST516	Alpha		14 47.9	-79.0	3.8	10°	Aps	21	star
ST517	∑1883		14 48.9	+05 57	7.6	0.7"	Vir	4	double star challenge
ST518	Mu		14 49.3	-14 09	5.4	2"	Lib	4	double star challenge
ST519	39		14 49.7	+48 43	5.7	3"	Boo	2	double star
ST520	58		14 50.3	-28.0	4.4	*	Hya	21	star
ST521	Kochab	Beta	14 50.7	+74.2	2.1	*	Umi	21	star
ST522	Zubenelgenubi	Alpha	14 50.9	-16.0	2.8	4'	Lib	2	double star
ST523	Xi	37	14 51.4	+19 06	4.6	7"	Boo	5	colored double star
ST524	h4715		14 56.5	-47.9	6	2.4"	Lup	2	double star
ST525	33	H 28	14 57.3	-21 22	5.9	23"	Lib	2	double star
ST526	Beta		14 58.5	-43.1	2.6	*	Lup	21	star
ST527	Pi		15 01.8	-83.2	5.7	18'	Oct	2	double star
ST528	44		15 03.8	+47 39	4.8	1.5"	Boo	4	double star challenge
ST529	Sigma		15 04.1	-25.3	3.2	*	Lib	1	red variable star
ST530	Dunlop178		15 11.6	-45.3	6.7	32"	Lup	2	double star
ST531	Kappa	Dunlop 177	15 11.9	-48.7	3.9	27"	Lup	2	double star
ST532	X		15 14.3	-70.1	8.1	*	Tra	22	variable star
ST533	∑1932		15 18.3	+26 50	6.6	1.5"	CrB	4	double star challenge
ST534	Mu	h4753	15 18.5	-47.9	5.1	1.2"	Lup	4	double star challenge
ST535	∑1931		15 18.7	+10 26	7	13"	Ser	2	double star
ST536	S		15 21.4	+31.4	5.8	*	CrB	22	variable star
ST537	Phi1		15 21.8	-36.3	3.6	50'	Lup	21	star
ST538	Eta		15 23.2	+30 17	5.6	1.0"	CrB	4	double star challenge
ST539	Mu		15 24.5	+37 23	4.3	2"	Boo	6	triple star
ST540	Edasich	Iota	15 24.9	+59.0	3.3	*	Dra	21	star
ST541	∑1972	Pi	15 29.2	+80 26	6.9	31"	Umi	2	double star
ST542	Lal123		15 33.1	-24 29	7.5	9"	Lib	3	double star equal magnitude
ST543	∑1954	Delta	15 34.8	+10.5	4	3.9"	Ser	2	double star
ST544	Gamma		15 35.1	-41.2	2.8	*	Lup	21	star
ST545	h4788	d	15 35.9	-45.0	4.7	2.2"	Lup	2	double star

Number	Name	Other	RA	Dec	Mag	Sep	Con	Code	
ST546	Upsilon	ADS 9705	15 37.0	-28.1	3.6	3"	Lib	5	colored double star
ST547	Omega		15 38.1	-42.6	4.3	*	Lup	1	red variable star
ST548	Σ1962		15 38.7	-08 47	5.8	12"	Lib	3	double star equal magnitude
ST549	Tau	40	15 38.7	-29.8	3.7	2°	Lib	21	star
ST550	Σ1965	Zeta	15 39.4	+36.6	5	6.3"	Crb	2	double star
ST551	Σ1967	Gamma	15 42.7	+26.3	4.2	0.3"	Crb	4	double star challenge
ST552	Unukalhai	Alpha	15 44.3	+06.4	2.7	*	Ser	21	star
ST553	R	V	15 48.6	+28 09	5.7	Stellar	CrB	22	variable star
ST554	Kappa	35	15 48.7	+18.1	4.1	*	Ser	1	red variable star
ST555	R		15 50.7	+15.1	5.2	*	Ser	22	variable star
ST556	Xi		15 56.9	-33 58	5.2	10"	Lup	2	double star
ST557	Rho	5	15 56.9	-29.2	3.9	*	Sco	21	star
ST558	Epsilon	13	15 57.6	+26.9	4.2	*	Crb	21	star
ST559	Pi	6	15 58.9	-26.1	2.9	*	Sco	21	star
ST560	T	V	15 59.5	+25 55	2	Stellar	CrB	22	variable star
ST561	Eta	Rmk 21	16 00.1	-38 24	3.6	15"	Lup	9	double star magnitude contrast
ST562	Delta	7	16 00.3	-22.6	2.3	*	Sco	21	star
ST563	Xi		16 04.4	-11 22	4.2	1"	Sco	8	triple star challenge
ST564	Graffias	Beta	16 05.4	-19.8	2.5	*	Sco	21	star
ST565	Omega1	9	16 06.8	-20.7	4	14'	Sco	21	star
ST566	Kappa		16 08.1	+17 03	5	28"	Her	5	colored double star
ST567	Nu		16 12.0	-19 28	4	1"	Sco	7	quadruple star
ST568	Yed Prior	Delta	16 14.3	-03.7	2.7	*	Oph	21	star
ST569	Σ2032	"17, Sigma"	16 14.7	+33 52	5.2	7"	CrB	2	double star
ST570	Delta		16 20.3	-78.7	4.7	*	Aps	2	double star
ST571	Sigma	H 121	16 21.2	-25 35	2.9	20"	Sco	9	double star magnitude contrast
ST572	Rho	ADS 10049	16 25.6	-23.5	5.3	3.1"	Oph	2	double star
ST573	V		16 26.7	-12.4	7.3	*	Oph	22	variable star
ST574	Epsilon	h4853	16 27.2	-47.6	4.8	23"	Nor	2	double star
ST575	Iota	Dunlop 201	16 28.0	-64.1	5.3	20"	Tra	2	double star
ST576	Σ2052	ADS 10075	16 28.9	+18.4	7.7	1.7"	Her	2	double star
ST577	Antares	Alpha	16 29.4	-26.4	1	3"	Sco	4	double star challenge
ST578	Lambda	ADS 10087	16 30.9	+02.0	4.2	1.4"	Oph	4	double star challenge
ST579	R		16 32.7	+66.8	6.7	*	Dra	22	variable star

Number	Name	Other	RA	Dec	Mag	Sep	Con	Code	
ST580	16		16 36.2	+52 55	5.1	3"	Dra	6	triple star
ST581	H		16 36.4	-35.3	4.2	*	Sco	21	star
ST582	Zeta	13	16 37.2	-10.6	2.6	*	Oph	21	star
ST583	SU		16 40.6	-32.4	8	*	Sco	22	variable star
ST584	Zeta	ADS 10157	16 41.3	+31.6	3	1.4"	Her	5	colored double star
ST585	Atria	Alpha	16 48.7	-69.0	1.9	*	Tra	21	star
ST586	Eta		16 49.8	-59.0	3.8	*	Ara	21	star
ST587	Epsilon	26	16 50.2	-34.3	2.3	*	Sco	21	star
ST588	Mu		16 52.3	-38.0	3	*	Sco	21	star
ST589	Σ2118	20	16 56.4	+65.0	7.1	1.4"	Dra	4	double star challenge
ST590	RR		16 56.6	-30.6	5.1	*	Sco	22	variable star
ST591	Kappa	27	16 57.7	+09.4	3.2	75'	Oph	21	star
ST592	Zeta		16 58.6	-56.0	3.1	*	Ara	21	star
ST593	Epsilon1		16 59.6	-53.2	4.1	40'	Ara	21	star
ST594	Mu		17 05.3	+54 28	4.9	2"	Dra	3	double star equal magnitude
ST595	Sabik	Eta	17 10.4	-15.7	2.4	0.6"	Oph	4	double star challenge
ST596	Rasalgethi	Alpha	17 14.6	+14.4	3	4.6"	Her	3	double star equal magnitude
ST597	Delta		17 15.0	+24 50	3.2	10"	Her	9	double star magnitude contrast
ST598	Pi	67	17 15.0	+36.8	3.2	7°	Her	21	star
ST599	36		17 15.3	-26 36	4.3	5"	Oph	3	double star equal magnitude
ST600	39		17 18.0	-24 17	5.2	10"	Oph	5	colored double star
ST601	Theta	42	17 22.0	-25.0	3.3	*	Oph	21	star
ST602	Σ2161	"75, Rho"	17 23.7	+37 09	4.2	4"	Her	2	double star
ST603	Beta		17 25.3	-55.5	2.9	*	Ara	21	star
ST604	Gamma		17 25.4	-56.4	3.3	*	Ara	21	star
ST605	Sigma	49	17 26.5	+04.1	4.3	4°	Oph	21	star
ST606	h4949	Dunlop 216	17 26.9	-45.9	6	2.2"	Ara	2	double star
ST607	Σ2173		17 30.4	-01 04	6	1.1"	Oph	4	double star challenge
ST608	Lambda	76	17 30.7	+26.1	4.4	*	Her	21	star
ST609	Lesath	Upsilon	17 30.8	-37.3	2.7	*	Sco	21	star
ST610	Alpha		17 31.8	-49.9	3	*	Ara	21	star
ST611	Nu		17 32.2	+55 11	4.9	62"	Dra	3	double star equal magnitude
ST612	Shaula	Lambda	17 33.6	-37.1	1.6	35'	Sco	21	star
ST613	Rasalhague	Alpha	17 34.9	+12 34	2.1	*	Oph	21	star
ST614	Iota	85	17 39.5	+46.0	3.8	*	Her	21	star

Number	Name	Other	RA	Dec	Mag	Sep	Con	Code	
ST615	Σ2241	Psi	17 41.9	+72 09	4.9	30"	Dra	2	double star
ST616	Kappa		17 42.5	-39.0	2.4	2.5°	Sco	21	star
ST617	V		17 43.3	-57.7	5.7	*	Pav	22	variable star
ST618	Cebalrai	Beta	17 43.5	+04.6	2.8	*	Oph	21	star
ST619	Σ2202	61	17 44.6	+02 34	6.2	21"	Oph	3	double star equal magnitude
ST620	SZ		17 45.0	-18.6	9	*	Sgr	22	variable star
ST621	SX		17 47.5	-35.7	8.5	*	Sco	22	variable star
ST622	G		17 49.9	-37.0	3.2	2°	Sco	21	star
ST623	Y		17 52.6	-06.2	6	*	Oph	22	variable star
ST624	Grumium	Xi	17 53.5	+56.9	3.8	*	Dra	21	star
ST625	Eltanin	Gamma	17 56.6	+51.5	2.2	*	Dra	21	star
ST626	Barnards Star		17 57.8	+04 34	9.5	Stellar	Oph	21	star
ST627	h5003		17 59.1	-30 15	5	6"	Sgr	5	colored double star
ST628	Σ2038	40-41	18 00.0	+80.0	5.7	20"	Dra	3	double star equal magnitude
ST629	95		18 01.5	+21 36	4.3	6"	Her	3	double star equal magnitude
ST630	Tau	ADS 11005	18 03.1	-08.2	5.2	1.8"	Oph	4	double star challenge
ST631	Σ2276	70	18 05.5	+02 30	4	1.5"	Oph	4	double star challenge
ST632	Theta		18 06.6	-50.1	3.7	*	Ara	21	star
ST633	Σ2280	100	18 07.8	+26 06	5.9	14"	Her	3	double star equal magnitude
ST634	W		18 14.9	+36.7	7.3	*	Lyr	22	variable star
ST635	Eta		18 17.6	-36.8	3.1	*	Sgr	21	star
ST636	Kappa	1	18 19.9	+36.1	4.3	*	Lyr	21	star
ST637	Kaus Media	Delta	18 21.0	-29.8	2.7	*	Sgr	21	star
ST638	Σ2306		18 22.2	-15 05	7.9	10"	Sct	2	double star
ST639	Xi	Gale 2	18 23.2	-61.5	4.4	*	Pav	21	star
ST640	Σ2323	39	18 24.0	+58 48	4.9	4"	Dra	6	triple star
ST641	21	ADS 11325	18 25.3	-20.5	4.9	1.8"	Sgr	4	double star challenge
ST642	Alpha		18 27.0	-46.0	3.5	6'	Tel	21	star
ST643	59		18 27.2	+00 12	5.2	4"	Ser	5	colored double star
ST644	Kaus Borealis	Lambda	18 28.0	-25.4	2.8	*	Sgr	21	star
ST645	SS		18 30.4	-16.9	9	*	Sgr	22	variable star
ST646	Delta		18 31.8	-45.9	5	11'	Tel	2	double star
ST647	T		18 32.3	+37.0	7.8	*	Lyr	1	red variable star
ST648	Δ222	Kappa	18 33.4	-38 44	5.9	21"	CrA	3	double star equal magnitude
ST649	Σ2348		18 33.9	+52 18	6	26"	Dra	2	double star

Number	Name	Other	RA	Dec	Mag	Sep	Con	Code	
ST650	Alpha		18 35.2	-08.2	3.9	*	Sct	21	star
ST651	O Σ 359		18 35.5	+23 36	6.3	0.7"	Her	4	double star challenge
ST652	O Σ 358	ADS 11483	18 35.9	+17.0	6.8	1.6"	Her	4	double star challenge
ST653	Vega	Alpha	18 36.9	+38 47	0	Stellar	Lyr	21	star
ST654	X		18 38.3	+08.8	5.9	*	Oph	22	variable star
ST655	HK		18 42.8	+37.0	9.5	*	Lyr	22	variable star
ST656	Σ 2398		18 43.0	+59.6	8	13"	Dra	2	double star
ST657	Double-Double	Epsilon	18 44.3	+39 40	4.7	2"	Lyr	7	quadruple star
ST658	Zeta		18 44.8	+37 36	4.4	44"	Lyr	2	double star
ST659	Σ 2375		18 45.5	+05 30	6.2	2"	Ser	3	double star equal magnitude
ST660	Σ 2379	5	18 46.5	-00 58	5.8	13"	Aql	6	triple star
ST661	R	V	18 47.5	-05 42	4.5	Stellar	Sct	22	variable star
ST662	Beta		18 50.0	+33 24	3.5	47"	Lyr	9	double star magnitude contrast
ST663	S	ADS 11726	18 50.3	-07.9	6.8	14.3"	Sct	2	double star
ST664	Σ 2404		18 50.8	+10 59	6.9	4"	Aql	2	double star
ST665	Σ 2420	Omicron	18 51.2	+59 22	4.9	35"	Dra	2	double star
ST666	Delta2	ADS 11825	18 54.5	+36.9	4.5	*	Cyg	21	star
ST667	O Σ 525		18 54.9	+33 58	6	45"	Lyr	5	colored double star
ST668	Nunki	Sigma	18 55.3	-26.3	2	*	Sgr	21	star
ST669	13	R	18 55.3	+43.9	3.9	4"	Lyr	21	star
ST670	Σ 2417	"63, Theta"	18 56.3	+04 11	4.1	22"	Ser	2	double star
ST671	ADS11871		18 57.0	+32.9	5.4	1"	Lyr	4	double star challenge
ST672	Σ 2422	ADS 11869	18 57.1	+26.1	8	0.7"	Lyr	4	double star challenge
ST673	UV		18 58.6	+14.4	8.6	*	Aql	22	variable star
ST674	Σ 2426		19 00.0	+12 53	7.1	17"	Aql	5	colored double star
ST675	Brs014		19 01.1	-37 03	6.6	13"	Cra	3	double star equal magnitude
ST676	h5082		19 03.1	-19 14	6	7"	Sgr	6	triple star
ST677	V	RV	19 04.4	-05 41	6.6	Stellar	Aql	1	red variable star
ST678	15		19 05.0	-04 02	5.4	38"	Aql	5	colored double star
ST679	Gamma		19 06.4	-37 00	5	3"	Aql	3	double star equal magnitude
ST680	R	RV	19 06.4	+08 14	5.5	Stellar	Aql	1	red variable star
ST681	Σ 2449		19 06.4	+07 09	7.2	8"	Aql	2	double star
ST682	Σ 2474		19 09.1	+34 35	6.5	16"	Lyr	2	double star

Number	Name	Other	RA	Dec	Mag	Sep	Con	Code	
ST683	Σ 2486		19 12.1	+49 51	6.6	8"	Cyg	3	double star equal magnitude
ST684	O Σ 178		19 15.3	+15.1	5.7	90"	Aql	2	double star
ST685	Tau	60	19 15.5	+73.4	4.5	*	Dra	21	star
ST686	RY		19 16.5	-33.5	6	*	Sgr	22	variable star
ST687	U	V	19 18.8	+19 37	6.6	Stellar	Sge	22	variable star
ST688	V1942		19 19.2	-15.9	6.4	*	Sgr	22	variable star
ST689	UX	RV	19 21.6	+76 34	5.9	Stellar	Dra	1	red variable star
ST690	RR	V	19 25.5	+42 47	7.1	Stellar	Lyr	22	variable star
ST691	Σ 2525	ADS 12447	19 26.6	+27.3	8.1	2"	Vul	2	double star
ST692	h5114		19 27.8	-54.3	5.7	70"	Tel	2	double star
ST693	Alpha	6	19 28.7	+24.7	4.4	*	Vul	21	star
ST694	Albireo	Beta	19 30.7	+28.0	3	35"	Cyg	5	colored double star
ST695	Mu	38	19 34.1	+07.4	4.5	*	Aql	21	star
ST696	AQ		19 34.3	-16.4	9.1	*	Sgr	22	variable star
ST697	R		19 36.8	+50.2	6.1	*	Cyg	22	variable star
ST698	HN84		19 39.4	+16 34	6.4	28"	Sge	5	colored double star
ST699	54	ADS 12767	19 40.7	-16.3	5.4	38"	Sgr	2	double star
ST700	TT		19 40.9	+32.6	7.8	*	Cyg	22	variable star
ST701	16		19 41.8	+50 32	6	39"	Cyg	3	double star equal magnitude
ST702	Σ 2579	"18, Delta"	19 45.0	+45 08	2.9	2"	Cyg	9	double star magnitude contrast
ST703	O $\Sigma\Sigma$ 191	H V 137	19 45.9	+35 01	6	39"	Cyg	5	colored double star
ST704	Tarazed	Gamma	19 46.3	+10.6	2.7	*	Aql	21	star
ST705	Σ 2580	17	19 46.4	+33 44	5	26"	Cyg	9	double star magnitude contrast
ST706	Delta	7	19 47.4	+18.5	3.8	*	Sge	21	star
ST707	Epsilon		19 48.2	+70 16	3.8	3"	Dra	9	double star magnitude contrast
ST708	Σ 2583	Pi	19 48.7	+11.8	6.1	1.4"	Aql	4	double star challenge
ST709	Zeta		19 49.0	+19 09	5	9"	Sge	2	double star
ST710	Chi	V	19 50.6	+32 55	3.3	Stellar	Cyg	22	variable star
ST711	Altair	Alpha	19 50.8	+08 52	0.8	*	Aql	21	star
ST712	Eta	55	19 52.5	+01.0	3.4	*	Aql	22	variable star
ST713	57		19 54.6	-08 14	5.7	36"	Aql	2	double star
ST714	O Σ 532	Beta	19 55.3	+06.4	3.7	13"	Aql	2	double star
ST715	Psi		19 55.6	+52 26	4.9	3"	Cyg	9	double star magnitude contrast
ST716	RR		19 55.9	-29.2	5.4	*	Sgr	22	variable star

Number	Name	Other	RA	Dec	Mag	Sep	Con	Code	
ST717	RU		19 58.7	-41.9	6	*	Sgr	22	variable star
ST718	Gamma	12	19 58.8	+19.5	3.5	*	Sge	21	star
ST719	BF		20 02.4	+21.1	8.5	*	Sge	22	variable star
ST720	h1470		20 03.6	+38 19	7.6	29"	Cyg	5	colored double star
ST721	X		20 05.1	+20.7	7	*	Sge	22	variable star
ST722	WZ		20 07.6	+17.7	7	*	Sge	22	variable star
ST723	Σ2675	Kappa	20 08.9	+77 43	4.4	7"	Cep	9	double star magnitude contrast
ST724	Σ2637	Theta	20 09.9	+20 55	6.4	12"	Sge	6	triple star
ST725	RY		20 10.4	+36.0	8.5	*	Cyg	22	variable star
ST726	FG		20 11.9	+20.3	9.5	*	Sge	35	planetary nebula irregular
ST727	Σ2644		20 12.6	+00 52	6.8	3"	Aql	3	double star equal magnitude
ST728	RS		20 13.4	+38.7	6.5	*	Cyg	22	variable star
ST729	Σ2658		20 13.6	+53 07	7.1	5"	Cyg	2	double star
ST730	Omicron1	"ADS 13554, V 695"	20 13.6	+46.7	3.8	*	Cyg	21	star
ST731	RT		20 17.1	-21.3	8.9	*	Cap	22	variable star
ST732	Alpha		20 17.6	-12.5	4.2	44"	Cap	21	star
ST733	RT		20 17.7	-39.1	6	*	Sgr	22	variable star
ST734	P		20 17.8	+38 02	3	Stellar	Cyg	22	variable star
ST735	Alpha		20 18.0	-12 32	3.8	7"	Cap	7	quadruple star
ST736	Σ2671		20 18.4	+55 23	6	4"	Cyg	2	double star
ST737	U		20 19.6	+47.9	5.9	*	Cyg	22	variable star
ST738	Dabih	Beta	20 21.0	-14.8	3.4	3'	Cap	2	double star
ST739	39	39	20 23.9	+32.2	4.4	*	Cyg	21	star
ST740	Peacock	Alpha	20 25.6	-56.7	1.9	*	Pav	21	star
ST741	pi		20 27.3	-18 13	5.3	3"	Cap	9	double star magnitude contrast
ST742	Omicron	SHJ 324	20 29.9	-18 35	6.1	19"	Cap	2	double star
ST743	Σ2716	49	20 41.0	+32 18	5.5	3"	Cyg	9	double star magnitude contrast
ST744	V		20 41.3	+48.2	7.7	*	Cyg	22	variable star
ST745	Deneb	Alpha	20 41.4	+45 17	1.3	*	Cyg	21	star
ST746	Σ2726	52	20 45.7	+30.7	4.2	6"	Cyg	2	double star
ST747	Gamma		20 46.7	+16 07	4.3	10"	Del	2	double star
ST748	Lambda	ADS 14296	20 47.4	+36.5	4.9	0.9"	Cyg	4	double star challenge
ST749	3		20 47.7	-05.0	4.4	*	Aqr	1	red variable star
ST750	S763		20 48.4	-18 11	6.7	16"	Cap	2	double star

Number	Name	Other	RA	Dec	Mag	Sep	Con	Code	
ST751	4	ADS 14360	20 51.4	-05.6	6.4	0.8"	Aqr	4	double star challenge
ST752	Omega	18	20 51.8	-26.9	4.1	*	Cap	21	star
ST753	Epsilon	1	20 59.1	+04 18	5.2	1"	Equ	8	triple star challenge
ST754	Σ2751	ADS 14575	21 02.1	+56.7	6.1	1.5"	Cep	4	double star challenge
ST755	Σ2742	2	21 02.2	+07 11	7.4	3"	Equ	3	double star equal magnitude
ST756	Dunlop236		21 02.2	-43.0	6	57"	Mic	2	double star
ST757	Lambda	ADS 14556	21 02.2	+07.2	7.4	3"	Equ	2	double star
ST758	12		21 04.1	-05 49	5.9	3"	Aqr	4	double star challenge
ST759	Xi	62	21 04.9	+43.9	3.7	*	Cyg	21	star
ST760	Σ2758	61	21 06.9	+38 39	5.2	29"	Cyg	2	double star
ST761	24	ADS 14632	21 07.1	-25.0	4.5	*	Cap	39	stellar planetary nebula
ST762	T		21 09.5	+68.5	5.2	*	Cep	22	variable star
ST763	Gamma		21 10.3	+10.1	4.7	6'	Equ	2	double star
ST764	Σ2780	ADS 14749	21 11.8	+60.0	5.6	1.0"	Cep	4	double star challenge
ST765	Delta		21 14.5	+10 00	4.6	48"	Equ	9	double star magnitude contrast
ST766	Theta	h5258	21 19.9	-53.5	4.5	6"	Ind	2	double star
ST767	RY		21 20.3	-10.8	8	*	Aqr	22	variable star
ST768	Y		21 24.3	-69.7	8.6	*	Pav	22	variable star
ST769	Beta		21 28.7	+70 33	3.3	13"	Cep	9	double star magnitude contrast
ST770	S	RV	21 35.2	+78 37	7.4	Stellar	Cep	1	red variable star
ST771	Σ2816		21 39.0	+57 29	5.6	12"	Cep	6	triple star
ST772	V460		21 42.0	+35.5	5.6	*	Cyg	22	variable star
ST773	SS		21 42.7	+43 35	8.2	Stellar	Cyg	22	variable star
ST774	RV		21 43.3	+38.0	7.1	*	Cyg	22	variable star
ST775	Herschel's Garnet Star	Mu	21 43.5	+58 47	3.4	Stellar	Cep	1	red variable star
ST776	Epsilon		21 44.2	+09 52	2.5	83"	Peg	9	double star magnitude contrast
ST777	Lambda	h5278	21 50.9	-82.7	5.4	3"	Oct	2	double star
ST778	AG		21 51.0	+12.6	6	*	Peg	22	variable star
ST779	Σ2840		21 52.0	+55 47	5.5	18"	Cep	2	double star
ST780	Σ2841	ADS 15431	21 54.3	+19.7	6.4	22"	Peg	2	double star
ST781	RX		21 56.4	+22.9	8	*	Peg	22	variable star

Number	Name	Other	RA	Dec	Mag	Sep	Con	Code	
ST782	Σ2873		21 58.4	+82 51	7.1	14"	Cep	3	double star equal magnitude
ST783	Eta	β 276	22 00.8	-28 27	5.8	1.9"	Psa	2	double star
ST784	29	S 802	22 02.5	-16 58	7.2	4"	Aqr	3	double star equal magnitude
ST785	Σ2863	"17, Xi"	22 03.8	+64 38	4.3	8"	Cep	2	double star
ST786	OΣ461	ADS 15601	22 03.9	+59.8	6.7	11.1"	Cep	2	double star
ST787	Lambda		22 06.1	-39.5	4.5	*	Gru	21	star
ST788	Al Nair	Alpha	22 08.2	-46 58	1.7	Stellar	Gru	21	star
ST789	Σ2883		22 10.7	+70 07	5.7	15"	Cep	2	double star
ST790	Zeta		22 10.9	+58.2	3.4	*	Cep	21	star
ST791	h1746	ADS 15758	22 13.9	+39.7	4.5	28"	Lac	2	double star
ST792	41		22 14.3	-21 04	5.3	5"	Aqr	5	colored double star
ST793	1		22 16.0	+37.7	4.1	*	Lac	21	star
ST794	Alpha		22 18.5	-60.3	2.9	5'	Tuc	21	star
ST795	Σ2894		22 18.9	+37 46	6.1	16"	Lac	5	colored double star
ST796	Pi		22 23.1	-45.9	5.8	2.7"	Gru	2	double star
ST797	S		22 26.1	-48.4	6	*	Gru	22	variable star
ST798	53		22 26.6	-16 45	6.4	3"	Aqr	3	double star equal magnitude
ST799	Delta	h5334	22 27.3	-65.0	4.5	7"	Tuc	2	double star
ST800	Kruger60	ADS 15972	22 28.1	+57.7	9.8	3"	Cep	2	double star
ST801	Zeta		22 28.8	-00 01	4.3	2"	Aqr	4	double star challenge
ST802	Delta		22 29.2	+58 25	3.8	20"	Cep	5	colored double star
ST803	5		22 29.5	+47.7	4.4	5'	Lac	21	star
ST804	Delta2		22 29.8	-43.7	4.1	15'	Gru	1	red variable star
ST805	Σ2912	37	22 30.0	+04.4	5.8	1"	Peg	4	double star challenge
ST806	Roe47		22 32.5	+39 46	5.8	43"	Lac	7	quadruple star
ST807	8		22 35.9	+39 38	6.5	22"	Lac	6	triple star
ST808	11		22 40.5	+44.3	4.5	*	Lac	21	star
ST809	Beta		22 42.7	-46.9	2.1	*	Gru	21	star
ST810	Tau1	69	22 47.7	-14.1	5.7	23"	Aqr	2	double star
ST811	Σ2947	ADS 16291	22 49.0	+68.6	7	4.3"	Cep	2	double star
ST812	Tau2	71	22 49.6	-13.6	4	40'	Aqr	21	star
ST813	Σ2950	ADS 16317	22 51.4	+61.7	6.1	1.7"	Cep	2	double star
ST814	h1823		22 51.8	+41 19	7.1	82"	Lac	7	quadruple star
ST815	Lambda	73	22 52.6	-07.6	3.7	*	Aqr	21	star

Number	Name	Other	RA	Dec	Mag	Sep	Con	Code	
ST816	Fomalhaut	Alpha	22 57.6	-29 37	1.2	*	PsA	21	star
ST817	52	ADS 16428	22 59.2	+11.7	6.1	0.7"	Peg	4	double star challenge
ST818	Scheat	Beta	23 03.8	+28.1	2.4	*	Peg	21	star
ST819	Dunlop246		23 07.2	-50.7	6.1	9"	Gru	2	double star
ST820	Σ2978		23 07.5	+32 49	6.3	8"	Peg	2	double star
ST821	Pi	ADS 16538	23 07.9	+75.4	4.6	1.2"	Cep	4	double star challenge
ST822	Phi	90	23 14.3	-06.0	4.2	*	Aqr	1	red variable star
ST823	Psi3		23 19.0	-09.6	5	1.5"	Aqr	2	double star
ST824	94		23 19.1	-13 28	5.1	13"	Aqr	5	colored double star
ST825	Dunlop249		23 23.9	-53.8	6.5	27"	Gru	2	double star
ST826	99		23 26.0	-20.6	4.4	*	Aqr	21	star
ST827	Z		23 33.7	+48 49	8	Stellar	And	22	variable star
ST828	Errai	Gamma	23 39.3	+77.6	3.2	*	Cep	21	star
ST829	Theta	Dunlop 251	23 39.5	-46.6	6.6	4"	Phe	2	double star
ST830	R		23 43.8	-15 17	5.8	Stellar	Aqr	22	variable star
ST831	107		23 46.0	-18 41	5.3	7"	Aqr	3	double star equal magnitude
ST832	TX	19	23 46.4	+03 29	6.9	Stellar	Psc	1	red variable star
ST833	Σ3042		23 51.8	+37 53	7.8	5"	And	3	double star equal magnitude
ST834	Lal192		23 54.4	-27 03	6.9	7"	Scl	2	double star
ST835	R		23 58.4	+51 24	4.7	Stellar	Cas	22	variable star
ST836	Sigma		23 59.0	+55 45	4.9	3"	Cas	5	colored double star
ST837	Σ3050		23 59.5	+33 43	6.6	1.5"	And	4	double star challenge

One-Year Limited Warranty

The Orion StarBlast 6 and StarBlast 6i Reflector Telescopes are warranted against defects in materials or workmanship for a period of one year from the date of purchase. This warranty is for the benefit of the original retail purchaser only. During this warranty period Orion Telescopes & Binoculars will repair or replace, at Orion's option, any warranted instrument that proves to be defective, provided it is returned postage paid to: Orion Warranty Repair, 89 Hangar Way, Watsonville, CA 95076. Proof of purchase (such as a copy of the original receipt) is required.

This warranty does not apply if, in Orion's judgment, the instrument has been abused, mishandled, or modified, nor does it apply to normal wear and tear. This warranty gives you specific legal rights, and you may also have other rights, which vary from state to state. For further warranty service information, contact: Orion Customer Service (800) 676-1343; support@telescope.com.

Orion Telescopes & Binoculars

89 Hangar Way, Watsonville CA 95076

Customer Support Help Line (800) 676-1343 • Day or Evening

© Copyright 2010-2013 Orion Telescopes & Binoculars