



N-14

Night Vision Monocular



OPERATION AND MAINTENANCE MANUAL

Important Export Restrictions! Commodities, products, technologies and services of this manual are controlled by the U.S. Department of State Office of Defense Trade Controls, in accordance with International Traffic in Arms (ITAR), Title 22, Code of Federal Regulations Part 120-130 and/or by the Export Administration Regulations (EAR) of U.S. Department of Commerce. At any time when a license or a written approval of the U.S. Government is applicable to it, it is illegal and strictly forbidden to export, intend to export, transfer in any other manner whatsoever, sell any hardware or technical data, provide any associated service to any non-U.S. resident, beyond or within the United States territory, until the valid license or written approval has been issued by the Departments of the U.S. Government having jurisdiction. Additionally U.S. law prohibits the sale, transfer, or export of items to certain restricted parties, destinations, and embargoed countries, as identified on lists maintained by the U.S. Department of State, the U.S. Department of Commerce, and the U.S. Department of Treasury. It is the responsibility of the Customer to be aware of these lists. The sale, transfer, transportation, or shipment outside of the U.S. of any product prohibited or restricted for export without complying with U.S. export control laws and regulations, including proper export licensing, documentation or authorization, is unlawful and may result in civil and/or criminal penalties and/or constitute a federal crime. Diversion contrary to U.S. law is strictly prohibited.

SAFETY SUMMARY

Before operating this product, carefully read and study this Operation and Maintenance Manual.

The N-14 is a precision electron-optical instrument, and requires careful handling. To avoid damage to the equipment or physical harm to the user when operating the N-14, follow all WARNINGS, CAUTIONS and NOTES.

Below you will find definitions of the following alerts that appear throughout this Manual:

WARNING — Identifies a clear danger to the person operating the equipment.

CAUTION – Identifies risk of damage to the equipment.

NOTE – Serves to highlight essential procedures, conditions, and statements, or convey important instructional data to the user.

WARNING:

This product contains natural rubber latex which may cause allergic reactions! The FDA has reported an increase in the number of deaths that are associated with an apparent sensitivity to natural latex proteins. If you are allergic to latex, it is a good idea to learn which products contain it and strictly avoid exposure to those products.

WARNINGS:

- When installing the unit on a weapon, be sure the weapon is CLEAR and that the SAFETY is on before proceeding.
- The light from the unit infrared (IR) illuminator is invisible to the unaided eye when used in total darkness. **However, the light can be detected by other Night Vision Devices (NVD).**
- To reduce the risk of detection by another NVD, avoid prolonged activation of the IR illuminator.
- The IR light is more detectable by an NVD when used in smoke, fog and rain. Avoid prolonged activation of the unit IR illuminator in these conditions.
- The intensifier's phosphor screen contains toxic materials. Please note the following:
 - If the intensifier tube breaks, be **extremely careful** to avoid inhaling the phosphor screen material. DO NOT allow the material to come in contact with your mouth, eyes, or any open wounds on the skin.
 - If the phosphor screen material comes in contact with your skin, wash it off immediately with soap and water.
 - If you inhale or swallow any phosphor screen material, drink a lot of water, induce vomiting, and **seek medical attention as soon as possible.**

The information provided in this manual is for familiarization purposes only. The contents may undergo further changes with no commitment by Armasight® to notify customers of any updates.

Armasight® assumes no responsibility for any misprints or other errors that this manual may contain.

©2013 by Armasight. All rights reserved.

CAUTION:

- The N-14 is a precision electron-optical instrument, and must be handled carefully at all times to prevent damage to the device and danger to the user.
- To protect the intensifier tube, **do not remove** the lens cap of the N-14 when the monocular is being operated in daylight conditions, or when the device is not in use.
- Use of the N-14 in brightly lit conditions may damage the unit's intensifier tube.
- Bright light sources such as firelight, headlights, searchlights, etc. can damage the N-14. Avoid exposing the unit to these types of light sources.
- Before removing the lens cap, verify that the photoreceiver is open.
- DO NOT forget to open the photoreceiver after completing your mission.
- DO NOT attempt to force the controls past their stopping points, as this may cause damage to the mechanisms.
- The unit may be badly damaged if the tripod on which it is mounted collapses or overturns. Remove the unit from the tripod if it is not within your reach.
- Before replacing the intensifier tube, confirm that it is no longer covered by warranty.
- Thoroughly dry each component of the N-14 before placing them in the storage case.

NOTES:

- The equipment requires some ambient light (moonlight, starlight, etc.) to operate.
- Performance of the device in nighttime conditions depends on the level of ambient light in the environment. Please remember the following:
 - The level of ambient light is reduced by the presence of clouds, shade, or objects that block natural light (trees, buildings, etc.).
 - The equipment is less effective when operated in shadows and other darkened areas.
 - The equipment is less effective when operated in rain, fog, sleet, snow, dust or smoke.
 - The equipment will not "see" through dense smoke.
- At operating temperatures below -20°C (-4°F), the use of an alkaline battery is not recommended, as the battery life will be severely reduced. Under said conditions, lithium-iron disulfide 1.5V AA batteries or their equivalent should be used.
- The IR illuminator is intended for increased illumination, as needed, when viewing at a close distance of up to 3m.
- The N-14 is **not** a weapon sight. However, it can be used in conjunction with a collimator dot sight or laser aiming device.
- If you are operating the N-14 while it is mounted on a weapon, Armasight recommends replacing the N-14 eyecup with an eyeguard.
- For the purpose of returning defective components, retain all packaging materials.

LIST OF CONTENTS

TITLE	PAGE
Safety Summary	2
List of Contents	4
List of Figures	5
List of Tables	6
How to Use This Manual	6
1. INTRODUCTION	7
1.1 General Information	7
1.1.1 Type of Manual	7
1.1.2 Model Number and Equipment Name	7
1.1.3 Purpose of Equipment	7
1.1.4 Reporting Equipment Improvement Recommendations	7
1.2 Warranty Information and Registration	8
1.2.1 Warranty Information	8
1.2.2 Limitation of Liability	8
1.2.3 Product Warranty Registration	8
1.2.4 Obtaining Warranty Service	9
1.3 Cross References	9
1.4 List of Abbreviations	10
2. DESCRIPTION AND DATA	11
2.1 System Description	11
2.2 Specifications	12
2.3 Standard Components	14
2.4 Optional Equipment	15
2.5 Key Features	18
3. OPERATING INSTRUCTIONS	19
3.1. Installation and Mounting	19
3.1.1 Battery Installation	19
3.1.2 Mounting the N-14 to a Goggle Kit	20
3.1.3 Mounting the N-14 to a Helmet	20
3.1.4 Mounting the N-14 to a Weapon with a Picatinny Mount Adapter	21
3.1.5 Mounting the N-14 to a Weapon with a Quick Release Picatinny Mount Adapter	22
3.1.6 Mounting the N-14 to a Scope	22
3.1.7 Mounting the N-14 to a Dual Bridge	23
3.1.8 Mounting an IR Illuminator to the N-14	23
3.1.9 Mounting the N-14 to a Standard US Mil Helmet/Headgear Assembly	24
3.1.10 Mounting Accessory Lenses to the N-14	24
3.1.11 Mounting the N-14 to a Weapon with an AIM Advance Aiming Mount	25
3.1.12 Mounting a Camera/Camcorder to the N-14	25
3.1.13 Universal Camera Adapter Application	25
3.1.14 Mounting a Demist Shield to the N-14	26
3.1.15 Mounting a Sacrificial Window to the N-14	26
3.2 Controls and Indicators	26
3.2.1 Controls and Indicators	26

3.3 Operating Procedures	27
3.3.1 Operating Procedures	27
3.3.2 IR Illuminator Operations	28
3.3.3 Operating Under Changing Light Conditions	28
3.3.4 N-14 Shut-Down	29
3.4 Storage	29
3.4.1 Preparation for Storage	29
4. PREVENTIVE MAINTENANCE AND TROUBLESHOOTING	30
4.1 Preventive Maintenance Checks and Services	30
4.1.1 Preventive Maintenance Checks and Services (PMCS)	30
4.2 Troubleshooting	32
4.2.1 Operator Troubleshooting	32
4.3 Identification of Operational Defects	32
4.3.1 Operational Defects	32
4.3.2 Cosmetic Blemishes	33
4.4 Maintenance	35
4.4.1 General	35
4.4.2 Cleaning Procedures	35
4.4.3 Battery Removal and Replacement	35
4.4.4 Goggle Kit Maintenance	35
4.5 Service/Packing and Unpacking	37
4.5.1 Return Instructions	37
APPENDIX	38
A. N-14 List of Spare Parts	38
B. Intensifier Tube Replacement Manual	39
C. Product Warranty Registration Card	41

LIST OF FIGURES

FIGURE	TITLE	PAGE
2-1	N-14 Night Vision Monocular	12
2-2	N-14 Standard Components	14
3-1	Battery Installation	19
3-2	Mounting the N-14 to a Goggle Kit	20
3-3	Mounting the N-14 to a Helmet	21
3-4	Mounting the N-14 to a Weapon with Picatinny Adapter	22
3-5	Mounting the N-14 to a Weapon with a Quick Release Picatinny Mount Adapter	22
3-6	Mounting the N-14 to a Scope	23
3-7	Mounting the N-14 to a Dual Bridge	23
3-8	Mounting an IR Illuminator to the N-14	24
3-9	Mounting the N-14 to a Standard US Mil Helmet/Headgear Assembly	24
3-10	Mounting Accessory Lenses to the N-14	25
3-11	Mounting a Camera/Camcorder to the N-14	25
3-12	Universal Camera Adapter Application	26

3-13	N-14 Controls	26
3-14	IR Illuminator Operations	28
4-1	Shading	33
4-2	Edge Glow	33
4-3	Emission Points and Bright Spots	34
4-4	Fixed-Pattern Noise	34
4-5	Chicken Wire	34
4-6	Browpad Replacement	36
4-7	Chin Strap Reinstallation	36
4-8	Chin Cup Replacement	36
A-1	N-14 Spare Parts	38
B-1	Intensifier Tube Replacement	40

LIST OF TABLES

TABLE	TITLE	PAGE
2-1	N-14 System Description	12
2-2	Mechanical Data	12
2-3	Electrical Data	13
2-4	Optical Data	13
2-5	Environmental Data	14
2-6	N-14 Standard Components	14
2-7	N-14 Optional Equipment	15
3-1	N-14 Controls and Indicators	27
4-1	Preventive Maintenance Checks and Services	30
4-2	Operator Troubleshooting	32
A-1	N-14 List of Spare Parts	38

HOW TO USE THIS MANUAL

USAGE

You must familiarize yourself with the entire manual before operating the equipment. Before performing any kind of maintenance on your device, read the section on maintenance in its entirety. Follow all **WARNINGS**, **CAUTIONS**, and **NOTES**.

MANUAL OVERVIEW

This manual contains sections on Operating and Maintaining the N-14 Night Vision Monocular.

The list of Spare Parts can be found in Appendix A.

The Intensifier Tube Replacement Manual can be found in Appendix B.

The Product Warranty Registration Card can be found in Appendix C.

INTRODUCTION

1.1 GENERAL INFORMATION

1.1.1 TYPE OF MANUAL

Operation and Maintenance (including a List of Spare Parts and an Intensifier Tube Replacement Manual).

1.1.2 MODEL NUMBER AND EQUIPMENT NAME

N-14 Night Vision Multi-Use Minimonocular

1.1.3 PURPOSE OF EQUIPMENT

To provide the operator with the ability to observe at night under moonlight and starlight conditions.

The N-14 can be used as a handheld, head-mounted, helmet-mounted or weapon-mounted device to allow walking, weapon firing, short-range surveillance, map reading, vehicle maintenance, and administering of first aid.

The N-14 allows for horizontal and vertical adjustments when mounted to the user's head or helmet, and is equipped with an infrared light-emitting source (IR illuminator).

1.1.4 REPORTING EQUIPMENT IMPROVEMENT RECOMMENDATIONS

Recommendations from the user for improvements to the device are encouraged.

Mail your comments to Armasight Inc., 815 Dubuque Avenue, South San Francisco, CA 94080, USA.

Or, send an email to info@armasight.com.

1.2 WARRANTY INFORMATION AND REGISTRATION

1.2.1 WARRANTY INFORMATION

This product is guaranteed to be free from manufacturing defects in material and workmanship under normal use for a period of two (2) years from the date of purchase. In the event that a defect covered by the below warranty occurs during the applicable period stated above, Armasight, at its discretion, will either repair or replace the product; such action on the part of Armasight shall be the full extent of Armasight's liability, and the Customer's sole and exclusive reparation. This warranty does not cover a product if it has (a) been used in ways other than its normal and customary manner; (b) subjected to misuse; (c) subjected to alterations, modifications or repairs by the Customer or by any party other than Armasight without prior written consent of Armasight; (d) special order or "close-out" merchandise or merchandise sold "as-is" by either Armasight or the Armasight dealer; or (e) merchandise that has been discontinued by the manufacturer and either parts or replacement units are not available due to reasons beyond the control of Armasight. Armasight shall not be responsible for any defects or damage that in Armasight's view are a result from the mishandling, abuse, misuse, improper storage or improper operation of the device, including use in conjunction with equipment that is electrically or mechanically incompatible with, or of inferior quality to, the product, as well as failure to maintain the environmental conditions specified by the manufacturer. CUSTOMER IS HEREBY NOTIFIED THAT OPERATION OF THE EQUIPMENT DURING DAYLIGHT HOURS OR UNDER ANY EXCESSIVE LIGHT CONDITIONS MAY PERMANENTLY DAMAGE THE INTERNAL COMPONENTS OF THE UNIT AND SAID DAMAGE WILL NOT BE COVERED UNDER THIS WARRANTY. This warranty is extended only to the original purchaser. Any breach of this warranty shall be enforced unless the customer notifies Armasight at the address noted below within the applicable warranty period.

The customer understands and agrees that except for the foregoing warranty, no other warranties written or oral, statutory, expressed or implied, including any implied warranty of merchantability or fitness for a particular purpose, shall apply to the product. All such implied warranties are hereby and expressly disclaimed.

1.2.2 LIMITATION OF LIABILITY

Armasight will not be liable for any claims, actions, suits, proceedings, costs, expenses, damages or liabilities arising out of the use of this product. Operation and use of the product are the sole responsibility of the Customer. Armasight's sole undertaking is limited to providing the products and services outlined herein in accordance with the terms and conditions of this Agreement. The provision of products sold and services performed by Armasight to the Customer shall not be interpreted, construed, or regarded, either expressly or implied, as being for the benefit of or creating any obligation toward any third party of legal entity outside Armasight and the Customer; Armasight's obligations under this Agreement extend solely to the Customer. Armasight's liability hereunder for damages, regardless of the form or action, shall not exceed the fees or other charges paid to Armasight by the customer or customer's dealer. Armasight shall not, in any event, be liable for special, indirect, incidental, or consequential damages, including, but not limited to, lost income, lost revenue, or lost profit, whether such damages were foreseeable or not at the time of purchase, and whether or not such damages arise out of a breach of warranty, a breach of agreement, negligence, strict liability or any other theory of liability.

1.2.3 PRODUCT WARRANTY REGISTRATION

In order to validate the warranty on your product, Armasight must receive a completed Product Warranty Registration Card for each unit, or the Customer can complete a warranty registration on our website, at www.armsight.com. Please complete the included form (Appendix C) and immediately mail it to our Service Center:

Armasight Inc.
815 Dubuque Avenue
South San Francisco
CA 94080
United States of America.

1.2.4 OBTAINING WARRANTY SERVICE

To obtain warranty service on your unit, the End-user (Customer) must notify the Armasight service department via email. Send any requests to service@armasight.com to receive a Return Merchandise Authorization number (RMA). When returning any device, please take in the product to your retailer, or send the product, postage paid and with a copy of your sales receipt, to Armasight Corporation's service center at the address listed above. All merchandise must be fully insured with the correct postage; Armasight will not be responsible for improper postage or merchandise that becomes lost or damaged during shipment. When sending product back, please clearly write the RMA# on the outside of the shipping box. Please include a letter that indicates your RMA#, the Customer's Name, a Return Address, reason for the return, Contact information (valid telephone numbers and/or an e-mail address), and proof of purchase that will help us to establish the valid start date of the warranty. Product merchandise returns that do not have an RMA# listed may be refused, or a significant delay in processing may occur. Estimated Warranty service time is 10-20 business days. The End-user/ Customer is responsible for postage to Armasight for warranty service. Armasight will cover return postage/ shipping after warranty repair to the End-user/ Customer only if the product is covered by the aforementioned warranty. Armasight will return the product after warranty service by domestic UPS Ground service and/ or domestic mail. Should any other requested, required or international shipping methods be necessary, the postage/ shipping fee will be the responsibility of the End-user/ Customer.

1.3 CROSS REFERENCES

COMMON NAME	OFFICIAL NAME
Allen Wrench	Socket Head Screw Key
Battery Compartment	Battery Box Cover
Shipping Case	Textile Bag
Cotton Swab	Disposable Applicator
Neoprene Jack Plug	Plug Assembly
O-Ring	Gasket
Safety Screw	Electrical Dial-Knob Lock
Pattern Generator	Optical Instrument Reticule
Lens Covers	Exit Port Covers
Paddle Switch	Remote Cable Switch
Batteries	AA
Technical Manual	Operator and Field Maintenance Manual
Tape Fastener Loop	Fastener, Loop Tape
Tape Fastener Hook	Fastener, Hook Tape

1.4 LIST OF ABBREVIATIONS

C	Celsius (Centigrade)
CCW	counterclockwise
Cont'd	Continued
CW	clockwise
Dia	diameter
F	Fahrenheit
FOV	Field of View
g	gram
Gen	Generation
H	Height
hr	hour
IR	infrared
IT	Intensifier Tube
L	Length
LED	Light Emitting Diode
lx	lux
m	meter
mA	milliampere
min	minute
mm	millimeter
mW	milliwatt
nm	nanometer
No	Number
NV	Night Vision
NVD	Night Vision Device
Para	Paragraph
PMCS	Preventive Maintenance Checks and Services
QRM	Quick Release Mount
QTY	Quantity
RMA#	Return Merchandise Authorization number
s	second
seq	sequence
SR	Service Representative
VDC	Volts Direct Current
V	Volt
W	Width

DESCRIPTION AND DATA

2.1 SYSTEM DESCRIPTION

The N-14 is a hand-held, head-mounted, helmet-mounted, or weapon-mounted night vision system that allows the user to operate it while walking, firing weapons, conducting short-range surveillance, reading maps, conducting vehicle maintenance, or administering first aid in both moonlight and starlight conditions.

The N-14 utilizes the principle of intensification of the residual light that is reflected from the surrounding objects. The optical system of the unit consists of an objective lens, an intensifier tube (IT), and an eyepiece.

The N-14 automatic brightness adjustment system retains the same gain (image brightness), even under unsteady light conditions.

The N-14 automatic protective system controls illumination through a photoreceiver. If the illumination level surpasses 100-300 lx for more than 10 s, the unit will shut off automatically.

A built-in IR illuminator makes it possible to use the unit in low light or total darkness.

The N-14 uses LED lights to indicate illumination level, low battery, and to show the user that the IR illuminator is on.

The N-14 allows for vertical and fore-and-aft adjustment when mounted to the user's head or helmet, when focusing the lens, and when focusing the eyepiece.

NOTE:

The equipment requires some light (moonlight, starlight, etc.) to operate. Performance of the device depends upon the level of ambient light in the environment. Please remember the following:

- The level of ambient light in the environment is reduced by the presence of clouds, shade, or objects that block natural light (trees, buildings, etc).
- The equipment is less effective when operated in shadows and other darkened areas.
- The equipment is less effective when operated in rain, fog, sleet, snow, or smoke.
- Under starlight conditions, particularly in low-contrast environments such as snow-covered territory, sandy deserts, large bodies of water or grassy hills, the visibility may degrade, thereby disguising or masking changes in terrain.
- The equipment will not "see" through dense smoke.

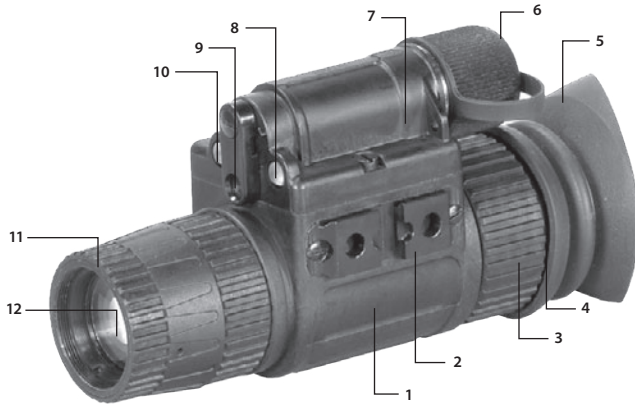

FIGURE 2-1. N-14 NIGHT VISION MONOCULAR

TABLE 2-1. N-14 SYSTEM DESCRIPTION

ITEM	DESCRIPTION	ITEM	DESCRIPTION
1	Body	7	Battery Compartment
2	Rail	8	Photo Receiver
3	Eyepiece Ring	9	Pivotal Focusing Lens
4	Eyepiece	10	IR Illuminator
5	Eye-cup	11	Focus Ring
6	Battery Cap	12	Lens

2.2 SPECIFICATIONS

TABLE 2-2. MECHANICAL DATA

EQUIPMENT ITEM	DIMENSIONS, MM (L X W X H)/(DIA X L)	WEIGHT, G
N-14 Night Vision Monocular	120x49x69	340
Flip-up Helmet Mount*	120x170x150	280
Goggle Kit*	280x180x80	295
Dual Bridge*	54x22x24	34
Picatinny/ Mil 1913 Weapon Mount Adapter*	110x59x13	58
Scope Adapter*	120x61x72	150
Sacrificial Window*	Dia 30x7	5
Demist Shield*	Dia 8.5x5.5	4
Camera Adapter*	Dia 60x22	52
Dovetail to Weaver Transfer Piece*	38x21x7.5	8

TABLE 2-2. CONTINUED

EQUIPMENT ITEM	DIMENSIONS, MM (L X W X H)/(DIA X L)	WEIGHT, G
Transfer Adapter to Standard US Mil Headset*	49x46x64	50
3X Afocal Lens*	Dia 77x95	553
5X Lens*	Dia 80x141	500
8X Lens*	Dia 96x211	730
8X Lens	Dia 96x211	730

* *Optional*

TABLE 2-3. ELECTRICAL DATA

ITEM	DATA
Battery	One AA (1.5 V) or 123A (3 V)
Consumption Current*:	
- at 1.5 VDC	75 mA
- at 3.0 VDC	38 mA
Continuous Operation* at 20 °C (68°F):	
- AA Alkaline Battery	30 (IT Gen. 2+) / 25 (IT Gen. 3)
- 123A Lithium Battery	60 (IT Gen. 2+) / 50 (IT Gen. 3)

* *With IR illuminator off.*

TABLE 2-4. OPTICAL DATA

ITEM	DATA
Magnification:	
— with 1X Lens	(1±0.05) X
— with 5X Lens*	(5±0.2) X
— with 8X Lens*	(8±0.5) X
— with 3X Afocal Lens* and F27 Lens	(3±0.15) X
1X Lens:	
— Focal Length	27 mm
— Lens F/number	1:1.2
Focus Range:	
— with 1X Lens	0.25 m to infinity
— with 5X Lens*	10 m to infinity
— with 8X Lens*	15 m to infinity
— with 3X Afocal Lens*	5 m to infinity
FOV:	
— with 1X Lens	40°
— with 5X Lens*	9°30'
— with 8X Lens*	6°30'
— with 3X Afocal Lens*	9°
Exit Pupil Diameter	14 mm
Eyepiece Focal Length	27 mm
Eye Relief	25 mm
Eyepiece Diopter Adjustment	-6 to +2 diopters

TABLE 2-4. CONTINUED

ITEM	DATA
Built-in IR Illuminator	
— Power	50 mW
— Illumination Range	20 m
— Focus Distance	3 m
— Illumination Wavelength	850 nm

* *Optional.*

TABLE 2-5. ENVIRONMENTAL DATA

ITEM	DATA
Operating Temperature	-40 to +50 °C
Storage Temperature	-50 to +70 °C
Humidity	95 %, 25 °C to 40 °C for 48 hr
Illumination Required	Natural night illumination (overcast starlight to moonlight)
Immersion	20 m for 1 hr
MIL-STD-810	Complies

2.3 STANDARD COMPONENTS

The standard components of the N-14 are shown in Figure 2-2 and listed in Table 2-6. The ITEM NO. column indicates the number used to identify items in Figure 2-2.



FIGURE 2-2. N-14 STANDARD COMPONENTS

TABLE 2-6. N-14 STANDARD COMPONENTS

ITEM NO.	DESCRIPTION	QUANTITY
1	Night Vision Monocular	1
2	Lens Cap	1
3	Eye-cup	1
4	Battery Adapter	1
5	Battery 123A Lithium	1
6	Operation and Maintenance Manual	1
7	Carrying Case	1
8	Neck Cord	1

1) Armasight N-14 Night Vision Monocular

Monocular night vision device with unity magnification.

2) Lens Cap

A cap used to protect the lens and to be used when testing the unit in daylight.

3) Eye-cup

A rubber cup used to protect the eyepiece as well as provide comfort for the operator.

4) Battery Adapter

Allows of use of a single 3V CR123 or 1.5V AA batteries.

5) Battery 123A Lithium

A single, 123A lithium battery used to power the unit.

6) Operation and Maintenance Manual

Provides safety information, equipment description, mounting procedures, operating instructions, and preventive maintenance checks and service (including a List of Spare Parts and an Intensifier Tube Replacement Manual).

7) Carrying Case

A protective case used for storing and carrying of the N-14 and its accessories.

8) Neck Cord

2.4 OPTIONAL EQUIPMENT

Optional items are shown and listed in Table 2-7.

The PART NO. column indicates the primary number used by the manufacturer to identify an item.

TABLE 2-7. N-14 OPTIONAL EQUIPMENT





IMAGE	DESCRIPTION	PART NO.
	3x A-Focal Lens #22 Quickly converts the N-14 into a long-range night vision device. Ideal for long range observation.	
	5X Lens #12 Quickly converts the N-14 into a long-range night vision device. Ideal for long range observation.	
	8X Lens #16 Quickly converts the N-14 into a long-range night vision device. Ideal for long range observation.	
	Goggle Kit #2 Adjustable universal assembly that secures the N-14 to the operator's head providing hands-free operation.	ANHG000004
	Helmet Mount #4 Helps to mount the N-14 on a range of ballistic helmets.	ANHM000008

TABLE 2-7. CONTINUED



















IMAGE	DESCRIPTION	PART NO.
	<p>MICH Helmet Mount Kit USA #105 Consists of MICH helmet mount and adapter that allows the user to attach the N-14 to this mount.</p>	ANHM000003
	<p>PASGT Helmet Mount Kit USA #106 Consists of PASGT helmet mount and adapter that allows the user to attach the N-14 to this mount.</p>	ANHM000004
	<p>Transfer Adapter/Swing Arm to PVS-7/PVS-14 Headset/Helmet #37 Mounts NV Monocular to Standard US Mil Headset (PVS7/PVS14 type) and/or helmet.</p>	ANHG000002
	<p>Picatinny Mount Adapter #93 Small arms adapter that allows the N-14 to be mounted on a weapon using a Picatinny Mil 1913 rail.</p>	ANAM000003
	<p>Double Lever-Lock Quick Release Picatinny Mount Adapter #26 Small arms adapter that allows the N-14 to be mounted on a weapon using Picatinny Mil 1913 rail.</p>	ANAM000004
	<p>AIM Advance Aiming Mount Allows the user to quickly convert the N-14 into a weapon sight.</p>	ANKI000001
	<p>Shuttered Eyeguard #82 Prevents light from being emitted by the N-14 eyepiece. If the user's face is illuminated, they become visible to others in the field, and their position becomes compromised.</p>	ANEC000001
	<p>Scope Adapter Mount #5 Allows the N-14 to be attached to variety of daytime rifle scopes or spotting scopes, offering the ultimate solution for day/ night operation.</p>	ANAM000002
	<p>IR810 Detachable Long Range IR illuminator w/Dovetail to Weaver Transfer Piece #21 Extra long-range infrared illuminator. Provides greater viewing capabilities when the environment has little or no ambient light.</p>	ANKI000016
	<p>IR850 Detachable Long Range IR illuminator w/Dovetail to Weaver Transfer Piece #21 Extra long-range infrared illuminator. Provides greater viewing capabilities when the environment has little or no ambient light.</p>	ANKI000017
	<p>Dovetail to Weaver Transfer Piece #21 Allows the IR illuminator to be mounted on the N-14.</p>	ANRA000001

TABLE 2-7. CONTINUED

IMAGE	DESCRIPTION	PART NO.
	<p>Dual Bridge #39 An adapter that allows the N-14 to be attached in a binocular configuration to a goggle kit or flip-up helmet mount.</p>	ANKI000003
	<p>Camera Adapter #46 An adapter with step down ring that allows the N-14 to be attached to any 35 mm SLR camera or 8 mm camcorder.</p>	ANAM000029
	<p>Universal Camera Adapter #45 Allows the N-14 to be attached to a variety of camera systems.</p>	ANAM000006
	<p>Time Tracker System #83 System/IIT service life recorder is a feature that lets you measure the hours of operation (within one minute) that have been used on the system.</p>	ANCA000001
	<p>Demist Shield #34 When attached to the N-14 eyepiece, the demist shield prevents condensation from developing on the optics under rapid temperature changes.</p>	ANLC000001
	<p>Sacrificial Window #30 This feature is useful in environments with large amounts of dust, dirt or debris in the air, as can be found in environments with high-speed winds or storm conditions. The sacrificial window preserves the objective lens of the N-14.</p>	ANLC000002
	<p>Hard Shipping/Storage Case #101 A protective case used for the shipping/ storage of the N-14 and its accessories.</p>	ANH000001

2.5 KEY FEATURES

- Gen 2+/3 intensifier tube
- Automatic bright light cut-off system to protect the intensifier tube
- LED lights visible in the eyepiece viewing area that indicate operation of the bright light cut-off system and IR illuminator, as well as to alert the user of a low battery
- Built-in IR illuminator with pivotal lens to select between IR spot and flood beam
- Left or right eye use
- Lightweight
- Compact and robust design
- Easy to operate
- Serviceability under severe conditions
- High-performance
- Highly reliable
- Powered by single CR123A or AA battery
- Weapon-mountable
- Head or helmet-mountable for hands-free usage
- Adaptable for use with cameras
- Automatic ON/ OFF feature with flip-up head/ helmet mount
- Compatibility with most weapons, IR laser aiming/ illuminating devices, reflex sights, and scopes
- Waterproof
- Limited two-year warranty

OPERATING INSTRUCTIONS

3.1 INSTALLATION AND MOUNTING

CAUTION:

To protect the intensifier tube when the sight is not in use or when it is being operated in daylight, keep the protective lens cap securely fitted over the lens.

3.1.1 BATTERY INSTALLATION

The N-14 operates on a single CR123A or AA battery.

Depending on the size of the battery used, it may be necessary to reposition the battery adapter within the battery cap.

NOTE:

If operating the device at temperatures below -20°C (-4°F), the use of an alkaline battery is not recommended, as the severe cold will adversely affect the life of the battery. In these conditions, it is recommended that you use a lithium-iron disulfide 1.5V AA battery, or its equivalent.

Install the CR123A battery as follows:

1. Unscrew the battery cap (A) and insert the CR123A battery (B), observing the polarity markings on the body of the device.
2. With the battery adapter (C) installed, screw the battery cap (A) back on securely.

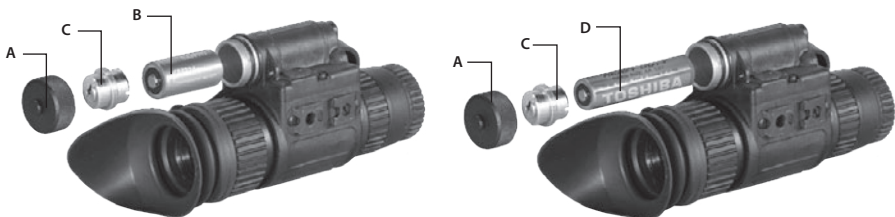

FIGURE 3-1. BATTERY INSTALLATION

Install the AA battery as follows:

1. Unscrew the battery cap (A).
2. Unscrew the battery adapter (C) from the cap, turn it around, and screw in the other end.
3. Insert the AA battery (D), observing the polarity markings as indicated on the body of the device.
4. Screw the battery cap (A) back into place.

3.1.2 MOUNTING THE N-14 TO A GOGGLE KIT

Mount the N-14 to the optional goggle kit as follows:

1. Put on the goggle kit. Adjust the goggle kit strap pads until the goggles fit securely around your head. Remove the goggle kit.
2. Loosen the screw (A). While pushing down on the button (B), insert the N-14 rail into the guide (C) of the goggle kit bracket. Tighten the screw (A). See Figure 3-2; the unit is shown in the correct positioning for the right eye.
3. Put on the goggle kit, now mounted with the N-14.
4. To adjust the equipment for greater comfort, loosen the screw (A) and move the unit along the guide (C).
5. The goggle kit has a flip-up mechanism. Push the button (D) of the goggle kit bracket and lift the unit up until it reaches its top position. The unit will automatically turn off when it reaches this position.
6. Push the same button (D) to lower the unit into the correct viewing position. Turn the unit back on to continue your session.

Figure 3-2 shows the N-14 in the correct position for the right eye. To readjust the unit for the other eye, remove the unit from the goggle kit bracket. Turn the unit around (180°) and mount it on the bracket through the rail on the second side. With the button (E) pushed, move the unit along the slide-rail (F) until the desired, most comfortable position is reached.

To remove the N-14 from the goggle kit, loosen the screw (A), push the button (B), and slide the unit out of the bracket guide (C).

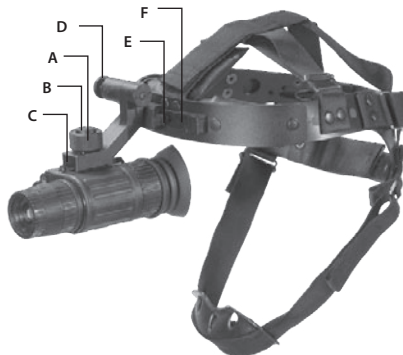

FIGURE 3-2. MOUNTING N-14 TO A GOGGLE KIT

3.1.3 MOUNTING THE N-14 TO A HELMET

An optional flip-up helmet mount can be used to attach the N-14 to a helmet. The helmet mount fits the N-14 securely onto helmet via a rugged strapping device and grooved hooks. With the helmet mount, the N-14 can be positioned directly in front of the user's eyes, or flipped backwards, out of the field of view.

Mount the N-14 to a helmet as follows:

1. Attach the mount to the helmet as shown in Figure 3-3.
2. Adjust and tighten the straps (A).

3. Loosen the screw (B). With the button (C) pushed down, insert the N-14 rail into the guide (D) of the helmet mount bracket. Tighten the screw (B).
4. Put on the helmet with the N-14 attached.
5. Push the button (F) and move the unit along the slide-rail (G) until the most comfortable position is reached.
6. To adjust the unit for comfort, loosen the screw (B) and move the unit along the guide (D).
7. To remove the N-14 and turn it around, push the button down (E) and lift the unit up until it reaches the top position. Once it reaches this position, the unit will turn off automatically.
8. Push the same button (E) to lower the N-14 into the proper viewing position. Turn the unit on to proceed with your mission.

In Figure 3-3, the N-14 is shown in the correct position for the right eye. To readjust the N-14 for the left eye, reverse its positioning and reinstall it on the helmet mount bracket (see Figure 3-3). Use the second unit rail located on the opposite side of the unit. Push the button (F) and move the unit along the slide-rail (G) until the most comfortable position is reached.

To remove the N-14 from the helmet mount, loosen the screw (B), push down on the button (C), and slide the unit out of the guide (D).

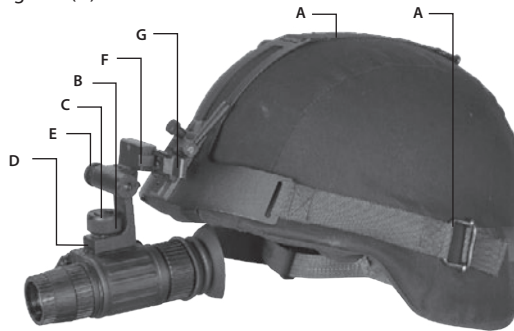

FIGURE 3-3. MOUNTING THE N-14 TO A HELMET

3.1.4 MOUNTING THE N-14 TO A WEAPON WITH A PICATINNY MOUNT ADAPTER

NOTE:

The N-14 is not a weapon sight. However, it can be used in conjunction with a collimator dot sight or laser aiming device.

NOTE:

If mounting the N-14 to a weapon, Armasight recommends replacing the standard eyecup with an eyeguard.

To mount the N-14 to a weapon using the optional Picatinny mount adapter, perform the following:

1. Loosen the clamping knobs (A) on the Picatinny mount adapter. Position the adapter on the weapon rail. Adjust the adapter's fore-and-aft positions by loosening the clamping knobs (A) and repositioning the adapter on the weapon rail. Tighten the clamping knobs (A).
2. Align the N-14 and the mount adapter. Slide the unit backwards until its alignment boss is parallel with the alignment groove (B) on the adapter. Push backwards until you hear a clicking noise indicating that the unit is locked into the weapon mount adapter.

3. To uninstall the N-14 from the mount adapter, push down on the lever (C) and remove the unit.
4. If necessary, you can change the height of the N-14 using an additional plate (D).

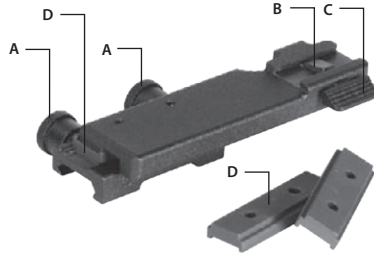

FIGURE 3-4. MOUNTING THE N-14 TO A WEAPON WITH A PICATINNY MOUNT ADAPTER

3.1.5 MOUNTING THE N-14 TO A WEAPON WITH A QUICK-RELEASE PICATINNY MOUNT ADAPTER

To mount the N-14 to a weapon using an optional quick-release Picatinny mount adapter (QRM), perform the following:

1. While pushing down on the lever holder (C), turn the lever (B) backwards to loosen the QRM clamping device (A).
2. Install the QRM on the weapon rail by inserting the stop (not shown in Figure 3-5) into one of transverse slots of the weapon rail.
3. To secure the QRM onto the weapon rail, turn the lever (B) forward. Secure the clamping device (A) tightly to the weapon rail. To adjust the force of the lever clamp, loosen or tighten the nut (D) as necessary.
4. While pushing down on the lever holder (F), turn the lever (E) forward.
5. Install the N-14 on the QRM rail by inserting the stop (G) into the transverse slot of the unit rail.
6. Attach the N-14 to the QRM rail by turning the lever (E) backwards. Secure the QRM clamping device (H) tightly to the N-14 rail. To adjust the force of the lever clamp, loosen or tighten the nut (I) as necessary.

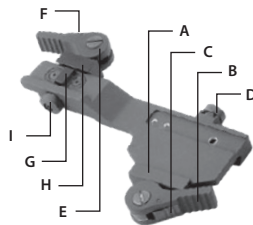

FIGURE 3-5. MOUNTING THE NYX-14 TO A WEAPON WITH A QUICK-RELEASE PICATINNY MOUNT ADAPTER

3.1.6 MOUNTING THE N-14 TO A SCOPE

To mount the N-14 to a daytime scope using an optional flip-up scope adapter, perform the following:

1. Loosen the adapter's fixing screw (A).
2. Install the insert into the adapter (Armasight supplies inserts of different sizes for coupling with 38-43mm eyepieces).
3. To attach the N-14 to the adapter bracket (B), push down on the button (C), loosen the fixing screw (D), and insert the unit rail into the bracket guide. Tighten the screw (D) to secure the N-14 to the bracket.
4. Insert the daytime riflescope eyepiece into the adapter (now attached to the N-14). Be sure to leave a small space between the riflescope eyepiece and the monocular's front lens.

5. Tighten the adapter fixing screw (A).
6. To work solely with the daytime scope, push down on the button (E) and flip the N-14 over (180°).

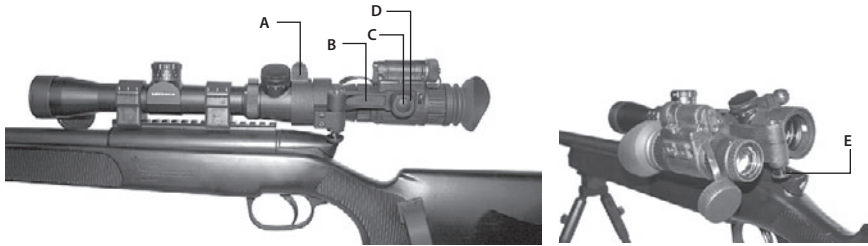

FIGURE 3-6. MOUNTING THE N-14 TO A SCOPE

3.1.7 MOUNTING THE N-14 TO A DUAL BRIDGE

To install two N-14 units onto a single binocular device, use the optional dual bridge. Perform the following steps:

1. Align the N-14 with the dual bridge (A).
2. Press down on the clamps (B) that are located on the front of the bridge.
3. Pull the unit back until the alignment boss is lined up against the groove (C) of the dual bridge. Push the unit back until it is securely fixed to the dual bridge.
4. Perform steps 1-3 with the second N-14 unit.

To remove the N-14 from the dual bridge, press down on the front clamps and slide the unit forward.

To configure the N-14 for long-range observation with binoculars, mount the 3x accessory lenses to the units as seen in Part 3.1.10 of this Manual.

To mount the dual bridge to the optional goggle kit, see Part 3.1.2 of this Manual.



FIGURE 3-7. MOUNTING THE N-14 TO A DUAL BRIDGE

3.1.8 MOUNTING AN IR ILLUMINATOR TO THE N-14

To mount an IR illuminator to the N-14, use the optional Dovetail to Weaver Transfer Piece. Perform the following steps:

1. Install the transfer piece (A) onto one of the N-14 rails.
2. Tighten the two fixing screws (B) on the transfer piece .
3. Loosen the IR illuminator fixing screw (C).
4. Mount the IR illuminator on the Weaver rail of transfer piece and tighten the fixing screw (C).



FIGURE 3-8. MOUNTING AN IR ILLUMINATOR TO THE N-14

3.1.9 MOUNTING THE N-14 TO A STANDARD US MIL HELMET/ HEADGEAR ASSEMBLY

To mount the N-14 to a Standard US Mil helmet or headgear assembly, use an optional transfer adapter. Perform the following steps:

1. Push down on the lever (C). Mount the adapter (A) to the N-14 rail (B).
2. Align the adapter prism (D) with the helmet/ headgear assembly mount (E). Slide the N-14 backwards until its alignment boss is in line with the alignment groove on the helmet/ headgear assembly mount. Push down until the N-14 locks into the helmet/ headgear assembly mount.

To dismount the N-14 from the helmet/ headgear assembly, push down on the lever (F) and remove the unit.

Push down on the lever (C) and remove the adapter from the N-14 rail.

The transfer adapter can be adjusted for either the right or left eye. In Figure 3-9, the N-14 is shown in the proper position for the left eye. Readjust the adapter for the right eye as follows:

- Push down on the lever (C). Remove the adapter from the N-14 rail.
- Loosen the nut (G), and turn the adapter around between the two fixing devices. Retighten the nut (G).
- Mount the adapter to the other N-14 rail located on the opposite side of the unit.

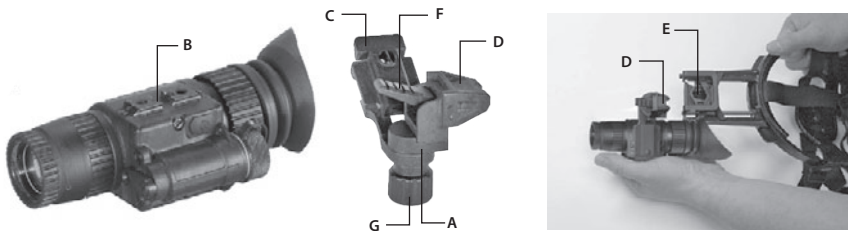

FIGURE 3-9. MOUNTING N-14 TO STANDARD US MIL HELMET/HEADGEAR ASSEMBLY

3.1.10 MOUNTING ACCESSORY LENSES TO THE N-14

To mount the 3X afocal lens (A) to the device, screw it into the threading of the standard 1X objective lens on the N-14.

To mount the 5X (B) or 8X (C) lens, unscrew the existing 1X objective lens of the N-14 and screw in the 3X, 5X or 8X lens in its place.

The N-14 configured with an 8X lens can be installed on a tripod. To mount the unit on a tripod, use the 1/4" threaded socket (D) on the housing of the 8X lens.



FIGURE 3-10. MOUNTING ACCESSORY LENSES TO N-14

NOTE:

The unit may be badly damaged if the tripod collapses or overturns. Remove the unit from the tripod if it is not within your reach.

3.1.11 MOUNTING THE N-14 TO A WEAPON WITH AN AIM ADVANCE AIMING MOUNT

The clamping system of the AIM advance aiming mount (AIM) is the same as is seen on the QRM. To mount the N-14 to a weapon with an AIM, see Part 3.1.5 of this Manual. This section details mounting instructions and procedures for the QRM.

For more information on the use of an AIM, see the AIM User’s Manual.

3.1.12 MOUNTING A CAMERA/ CAMCORDER TO THE N-14

To mount any 35mm SLR photographic camera or 8mm camcorder to the N-14, use the optional camera adapter and perform the following:

1. Using the (M37x0.75 threaded) adapter ring (B), screw the (M52x0.75 threaded) adapter (A) into the front lens of the photographic camera or video camera.
2. Remove the eyecup from the N-14 eyepiece.
3. Connect the adapter with the eyepiece and tighten the three fixing screws (C) located on the adapter.



FIGURE 3-11. MOUNTING A CAMERA/ CAMCORDER TO THE N-14

3.1.13 UNIVERSAL CAMERA ADAPTER APPLICATION

To mount the N-14 (affixed with a camera or video recorder) to a tripod, you will need a universal camera adapter. Mount the connected devices to a tripod as follows:

1. Screw the adapter onto the tripod.
2. Remove the eyecup from the N-14 eyepiece.
3. Install the N-14 on the adapter rail (A) and tighten the fixing screw (B).
4. Install the camera on the adapter rail (C) and insert the fixing screw (D) into the tripod socket of the camera. Tighten the fixing screw.
5. Loosen the screws one by one. Align the optical axis of the N-14 with the camera objective. Tighten the screws (E and F).
6. To focus the image, loosen the screw (G) and adjust the distance between the monocular and the camera’s eyepiece. Tighten the screw (G).

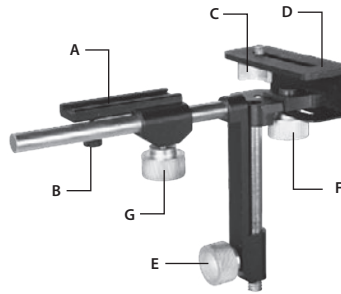

FIGURE 3-12. UNIVERSAL CAMERA ADAPTER APPLICATION

3.1.14 MOUNTING A DEMIST SHIELD TO THE N-14

Mount a demist shield to the N-14 as follows:

1. Remove the eyecup from the N-14 eyepiece.
2. Coat the demist shield with an anti-fogging compound, to prevent moisture condensation on the surface of the shield.
3. Screw the demist shield into the threading of the eyepiece.
4. Secure the eyecup back into place.

3.1.15 MOUNTING A SACRIFICIAL WINDOW TO THE N-14

Mount a sacrificial window to the N-14 as follows:

1. Remove the N-14 lens cap.
2. Screw the sacrificial window into the lens threading.

3.2 CONTROLS AND INDICATORS

3.2.1 CONTROLS AND INDICATORS

The N-14 controls and indicators are defined in Table 3-1.

The N-14 controls are shown in Figure 3-13.

CAUTION:

DO NOT over-adjust the controls by forcing them past their stopping points.

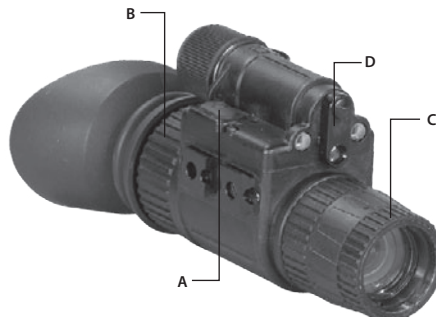

FIGURE 3-13. N-14 CONTROLS

TABLE 3-1. N-14 CONTROLS AND INDICATORS

CONTROL/INDICATOR	FUNCTION
Operation button (Figure 3-13, A)	To turn the monocular on, press button by one short push, to turn it off – press button by another short push. Operation button switches both the monocular and the IR Illuminator on/off.
Eyepiece Ring (Figure 3-13, B)	Adjusts the unit diopter. The total dioptric range is covered in a 1/2 ring revolution.
Focusing Ring (Figure 3-13, C)	Focuses the lens. Adjusts for sharpest view of the scene. The total focus range is covered in a 1/3 ring revolution.
Pivotal Focusing Lens (Figure 3-13, D)	Allows the user to choose between the following: 1. The IR illuminator spot beam. When the pivotal focusing lens is placed in the leftmost position of the window of the IR illuminator, the photoreceiver is open. 2. The IR illuminator flood beam. When the focusing lens is placed in the center position, the photoreceiver is opened. 3. The photoreceiver will close when the focusing lens is placed in the rightmost position.
Built-in LED Indicators	A GREEN GLOW in the eyepiece viewing area indicates excessive light conditions. After 10 s of exposure to bright light, the intensifier will shut off automatically. The unit will turn back on again when moved away from the excessive light.
	A PERMANENT RED GLOW in the eyepiece viewing area indicates that the IR illuminator is operating.
	A FLASHING RED LIGHT in the eyepiece viewing area indicates that the battery is low.

3.3 OPERATING PROCEDURES

3.3.1 OPERATING PROCEDURES

These procedures should be performed under nighttime conditions only.

CAUTION:

Use of the N-14 brightly lit conditions may damage the unit's intensifier tube.

1. Verify that the battery is installed as indicated on the monocular body.
2. Make a visual estimation of the illumination level in the viewing area. The required level of illumination is less than 1 lx (late twilight sky conditions).
3. Remove the lens cap and place it over the housing of the lens.

CAUTION:

Before removing the objective lens cap, verify that the photoreceiver is open.

4. Turn the function switch ON. After a slight delay, a green glow will appear in the eyepiece of the monocular.
5. Adjust the unit diopter by rotating the ring of the eyepiece.
6. Observe the scene. Rotate the focus ring until the image is clear and sharp.

CAUTION:

Bright sources such as firelight, headlights, searchlights, etc. can damage the N-14. Avoid exposing the unit to these types of light sources.

3.3.2 IR ILLUMINATOR OPERATIONS

CAUTION:

When operating the device in extremely dark conditions, the light from the unit's IR illuminator will be invisible to the unaided eye. However, the light can be detected by other NVDs.

NOTE:

The IR illuminator is designed to provide additional illumination (when needed) while viewing scenes or targets from a short distance (up to 3m).

1. IR Illuminator gets activated when the monocular is already on by holding button (A) pressed for 1,5-2 seconds. A red light appears in the eyepiece to indicate that the IR illuminator is operating.
2. You may focus the IR light for additional distance by placing the focusing lens of the IR pivot plate (B) onto the window of the IR illuminator (C). This will extend the range the useful range of the IR.

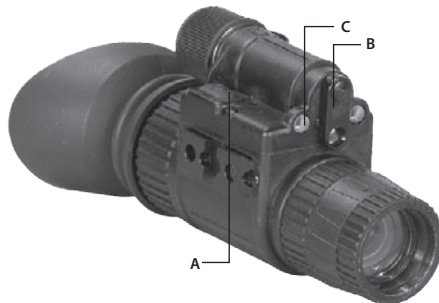

FIGURE 3-14. IR ILLUMINATOR OPERATIONS

3.3.3 OPERATING UNDER CHANGING LIGHT CONDITIONS

If the ambient light level exceeds the limit of 100-300 lx for more than 10 s, the N-14 automatic protective system will shut off the intensifier tube. If a mission must be carried out in changing light conditions, the user can shut down the protective system manually by closing the photoreceiver.

CAUTION:

DO NOT forget to open the photoreceiver after completing your mission.

3.3.4 N-14 SHUT-DOWN

1. Press button by one short push, to turn it off
2. Secure the lens cap over the objective lens.
3. If necessary, remove the unit from the rail (from the scope lens). Remove the unit by following the mounting instructions in reverse.
4. Unscrew the battery cap and take out the battery. Replace the battery cap. Do not store the unit with the battery still in it.
5. Store the unit and all accessories in the case.

3.4 STORAGE

3.4.1 PREPARATIONS FOR STORAGE

Prepare the N-14 for storage as follows:

1. Verify that the N-14 and all accessories are clean and dry before returning them to the storage case.
2. Secure the cap over the objective lens.
3. Remove the battery.
4. Place the N-14 and accessories in the appropriate locations in the case, and close the cover.

PREVENTIVE MAINTENANCE AND TROUBLESHOOTING

4.1 PREVENTIVE MAINTENANCE CHECKS AND SERVICES

4.1.1 PREVENTIVE MAINTENANCE CHECKS AND SERVICES (PMCS)

Table 4-1: Preventive Maintenance Checks and Services has been provided so that you can keep your equipment operable and in good condition.

Perform all functional tests in the order listed in Table 4-1.

Operating Procedures are detailed in Chapter 3.

A. Cautions

Always observe any CAUTIONS that appear in the table.

B. Explanation of Table Entries

SEQ NO. column. Sequence numbers are for reference and appear in the order required to perform checks and services.

LOCATION/ITEM TO CHECK/SERVICE column. Indicates the location and the item to be checked or serviced.

PROCEDURE column. Details the checking/ servicing procedure.

NOT FULLY MISSION CAPABLE IF column. Indicates what faults will prevent your equipment from operating successfully.

TABLE 4-1. PREVENTIVE MAINTENANCE CHECKS AND SERVICES

SEQ NO.	LOCATION ITEM TO CHECK/SERVICE	PROCEDURE	NOT FULLY MISSION CAPABLE IF
BEFORE OPERATION CHECKS			
1	Completeness	Open the carrying case and inventory items by means of comparing with the data specified in this manual.	Items are missing.
2	Soft Carrying Case	Shake out loose dirt or foreign material. Inspect for tears, cuts, excess wear or damage to the mounting clips.	
3	External Surfaces	Inspect for cracks or damage. Scratches and gouges are OK if operation is not affected.	Cracked or damaged.
4	Lens Cap	Inspect for cracked, torn, or missing lens caps.	Cap is torn or cut. Cup is not secured to the housing of the lens.

TABLE 4-1. CONTINUED

SEQ NO.	LOCATION ITEM TO CHECK/SERVICE		PROCEDURE	NOT FULLY MISSION CAPABLE IF
5	Eyecup		Inspect for dirt, dust. Inspect for cracked or torn, bent, broken or improperly fitting eyecup. If necessary, clean as per Para 4.4.2.	Cup torn or cut.
6	Battery Adapter/ Compartment/ Cap		Verify that the battery adapter is present. Inspect for corrosion, moisture, corroded or defective contacts. Verify that the o-ring is present.	Adapter is missing, contacts damaged or corroded, or o-ring is missing.
7	Function Switch		Check the switch for operation (without a battery).	Switch has no definite stopping points. Switch knob is broken or missing.
8	Pivotal Lens	Focusing	Check to make sure pivotal focusing lens is present.	Pivotal focusing lens is missing.
9	Lenses		Inspect optical surfaces for dirt, fingerprint residue, scratches, chips, or cracks.	Scratches or chips hinder vision with N-14 turned on. Cracks are present. Photoreceiver damaged. Pivotal focusing lens damaged.
10	Focusing Ring		Rotate the focusing ring to ensure free movement (range is approximately 1/3 turn).	Ring gets stuck or adversely affects the user's ability to properly focus the unit.
11	Eyepiece Ring		Rotate the eyepiece ring to make sure the eyepiece is not too tight or too loose. Range is approximately ½ turn.	Ring gets stuck, is too loose, or adversely affects the user's ability to properly adjust the diopter.
12	Optional Equipment	Equip-	Inspect optional items for dirt, or corrosion, damage, and missing parts. Check for proper operation. If necessary, clean as detailed in Part 4.4.2.	Equipment is damaged or parts are missing.

OPERATIONAL CHECKS

CAUTION:

Do not activate the N-14 in daylight unless the lens cap is on, or you are operating under dark conditions.

CAUTION:

Do not forget to open the photoreceiver after finishing operational checks.

NOTE:

Daylight checks are described below.

13	Function Switch	Install the battery. Verify that the photoreceiver is open. Turn the switch from OFF to ON. Look for the green glow in eyepiece (it should appear after a slight delay), and wait about 10 s for image to disappear. Look for a flashing red light in eyepiece viewing area.	Image is present. Red light is flashing.
		Close the photoreceiver by placing the pivotal focusing lens in rightmost position. Pull out the IR and turn the switch from ON to the IR position. Look for a permanent red glow in the eyepiece viewing area. Turn the switch from IR to ON position.	Permanent red glow is absent
14	Viewed Image	Inspect for any operational defects (refer to Part 4.3.1: Identification of Operational Defects).	Shading, edge glow, flashing, flickering, and intermittent operation, or excessive cosmetic defects are found.

AFTER CHECKING PROCEDURES

15	Turn the unit OFF. Verify that the green glow fades from the eyepieces. Remove the battery. Return the unit and all accessories to the soft carrying case.
----	------------------------------------------------------------------------------------------------------------------------------------------------------------------

4.2 TROUBLESHOOTING

4.2.1 OPERATOR TROUBLESHOOTING

The purpose of troubleshooting is to identify the most frequently occurring equipment malfunctions, their probable causes, and the corrective actions required to fix them.

Table 4-2 lists common malfunctions that may occur during the operation or maintenance of the N-14. Perform the tests, inspections, and corrective actions in the order listed in the table.

This table does not list all of the malfunctions that may occur with your device, or all of the tests and corrective actions that may be necessary. If you experience an equipment malfunction that is not listed, or is not fixed by the corrective actions listed in the table, please contact Armasight's Customer Service center.

TABLE 4-2. OPERATOR TROUBLESHOOTING

MALFUNCTION	PROBABLE CAUSE/ TEST/INSPECTION	CORRECTIVE ACTION
Monocular fails to activate.	Battery is dead, missing or improperly installed.	Replace the battery or install it correctly.
	Battery contact surfaces or contact springs are dirty or corroded.	Clean the contact surfaces with a pencil eraser and/ or alcohol and cotton swabs.
	Defective image intensifier.	Please contact Customer Support.
Battery adapter difficult to remove.	Check for damaged battery adapter and battery cap.	If damaged please contact Customer Support.
IR illuminator fails to activate.	Turn the IR illuminator on in a dark area. Visually estimate whether or not the observed scene is illuminated.	If the IR illuminator fails to activate, please contact Customer Support.
LED indicators fail to activate.	Visual inspection.	Please contact Customer Support.
Poor image quality.	Check objective lens or eyepiece focus.	Refocus the lens.
	Check for fogging or dirt on the lens.	Clean the lens as detailed in Part 4.4.2. If image quality is still poor, please contact Customer Support.
	Damaged optical components.	Please contact Customer Support
Light is visible around the eyecup.	Check the exit pupil distance value.	Readjust for proper eye-relief distance.
	Check the eyecup resilience.	If the eyecup is defective, please contact Customer Support.
Focusing ring cannot be moved.	Check to see if the focusing ring is bent or broken.	If damaged, please contact Customer Support.
Eyepiece ring cannot be moved.	Check to see if the eyepiece ring is bent or broken.	If damaged, please contact Customer Support.

4.3 IDENTIFICATION OF OPERATIONAL DEFECTS

4.3.1 OPERATIONAL DEFECTS

Operational defects relate to the reliability of the intensifier, and are an indication of instability. If identified, the user will need to return the N-14 immediately. Operational defects include shading, edge glow, flashing, flickering, and intermittent operation.

A. Shading

If shading is persistent, you will not be able to see a fully circular image (Figure 4-1). Shading is a very dark, high-contrast area with a distinct line of demarcation present, and you cannot see an image through it. Shading always begins on the edge, and will eventually migrate inward until it spans across the entire image area. If you notice shading with your device, please contact Customer Support.

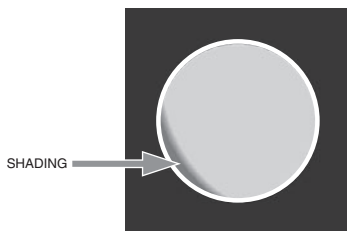

FIGURE 4-1. SHADING

NOTE:

Verify that any shading is not the result of improper eye-relief adjustment.

B. Edge Glow

Edge glow is a bright area (it sometimes appears to be sparkling) in the outer portion of the viewing area (see Figure 4-2). To check for edge glow, block out all light from the device by cupping a hand over the lens. If the image tube is displaying edge glow, the bright area will still show up; if edge glow occurs, please contact Customer Support.

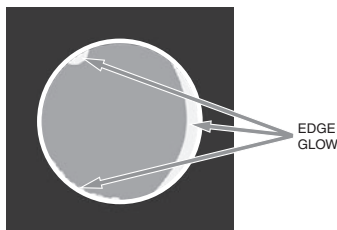

FIGURE 4-2. EDGE GLOW

C. Flashing, Flickering, or Intermittent Operation

The image may appear to flicker or flash. If there is more than a single flicker, check for a loose battery adapter or a weak battery. If flickering continues, please contact Customer Support.

4.3.2 COSMETIC BLEMISHES

Cosmetic blemishes are usually the result of manufacturing imperfections. They **do not** affect the reliability of the image intensifier, and are not normally a cause for returning the N-14. However, some types of cosmetic blemishes can worsen over time and interfere with the user's ability to properly operate the device during missions. If you believe a cosmetic blemish is cause for returning the device, record the specific nature of the problem on the maintenance forms and use the clock method to identify the position of the blemish and its approximate distance from the center (e.g., 5:00 toward the outside, 2:30 near the center, or 1:00 midway).

The following are examples of cosmetic blemishes:

A. Bright Spots

A bright spot is a small, non-uniform bright area that may flicker or appear constant (Figure 4-3).

Not all bright spots make the N-14 rejectable. Cup your hand over the lens to block out all light. If the bright spot remains please contact Customer Support.

Bright spots usually go away when all light is blocked out. Verify that any bright spots are not simply the result of bright light in the area you are observing. Bright spots are acceptable if they do not interfere with the user's ability to view the scene or perform missions.

B. Emission points

Emission points are steady or fluctuating pinpoints of bright light in the image area that do not go away when all external light is blocked from the objective lens (Figure 4-3). The position of an emission point within the image area does not move. Not all emission points are cause to return the N-14. Verify that emission points are not simply light sources present in the scene you are observing. Emission points are acceptable if they do not interfere with the user's ability to perform missions.

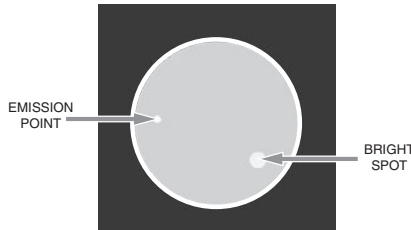

FIGURE 4-3. EMISSION POINTS AND BRIGHT SPOTS

C. Black Spots

Black spots are cosmetic blemishes in the image intensifier or debris between the lenses. Black spots are acceptable as long as they do not interfere with the user's ability to observe the scene. No action is required if this condition is present, unless the spots interfere with the operator's ability to perform missions.

D. Fixed-pattern Noise

Fixed-pattern noise is usually a cosmetic blemish characterized by a faint hexagonal (honeycomb) pattern that appears throughout the viewing area. This typically occurs in excessively lit environments or when viewing very bright lights (See Figure 4-4). This pattern can be seen in every image intensifier if the level of light is high enough. This condition is acceptable as long as the pattern does not interfere with the user's ability to view an image or interfere with their ability to perform missions.

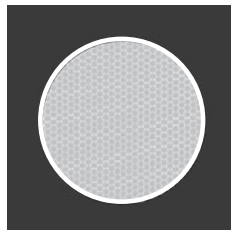

FIGURE 4-4. FIXED-PATTERN NOISE

E. Chicken Wire

Chicken wire is an irregular pattern of dark thin lines that can appear in the field of view, either throughout the image area or in sections of the image area (See Figure 4-5). In the worst-case scenario, these lines will form hexagonal or square-wave shaped lines. No action is required if this condition is present, unless it interferes with the user's ability to view the image or their ability to perform missions.



FIGURE 4-5. CHICKEN WIRE

4.4 MAINTENANCE

4.4.1 GENERAL

The section regarding N-14 operator maintenance consists of operational tests, inspections for the unit serviceability, cleaning and mounting procedures, troubleshooting, and replacement instructions for a limited number of parts. Maintenance instructions covered elsewhere in this manual (PMCS, troubleshooting, etc.) are not repeated in this section.

CAUTION:

The N-14 is a precision electron-optical instrument, and must be handled carefully at all times to prevent damage to the device's body or mechanisms.

4.4.2 CLEANING PROCEDURES

CAUTION:

The coating on the demist shield can be damaged if the shield is cleaned while wet, or if it is cleaned with wet lens paper. Clean the shield only when it is dry, and only use dry lens paper.

CAUTION:

Thoroughly dry each item before placing them into the storage case.

Clean the N-14 as follows:

1. Gently brush off any dirt from the unit's body using a clean, soft cloth.
2. Moisten the cloth with fresh water and gently wipe external surfaces (**except** for glass surfaces).
3. Dry any wet surfaces (**except** for glass surfaces) with another clean, soft, dry cloth.
4. Using a lens brush, carefully remove all loose dirt from the glass surfaces.
5. Slightly dampen a cotton swab with ethanol. Gently and slowly wipe the lenses (including the photoreceiver and the pivotal focusing lens). Without touching the lens holders, clean the glass surfaces in circular movements, beginning in the center and moving out towards the edge. Change the cotton swab after each circular stroke. Repeat until the glass surfaces are clean.
6. Clean the battery contact surfaces and contact springs with a pencil eraser and/ or alcohol-dampened cotton swabs.

Clean optional mounting devices with a soft brush (cloth), soap, and water as required.

Clean optional lenses as detailed in items 4 and 5 above (**except** for the demist shield).

4.4.3 BATTERY REMOVAL AND REPLACEMENT

Refer to Part 3.1.1 for battery installation procedures. No special tools are required to replace the battery.

4.4.4 GOGGLE KIT MAINTENANCE

A. Browpad Replacement

Replace the browpad when cracked, torn, or contaminated. Perform the following to remove and replace the browpads:

1. Firmly grasp the goggle kit and remove the old browpad.
2. Gently press on the new browpad. Gently smooth out any wrinkles in the new browpad.



FIGURE 4-6. BROWPAD REPLACEMENT

B. Chin Strap Reinstallation

1. Detach the Velcro tape from the left side of the head-band and remove the chin strap. Unfasten the chin strap from the strap assembly.
2. Replace the chin strap by joining the sides of the Velcro tape on the left side of the head-band and threading the end of another strap into the corresponding buckle on the right side of the head-band.

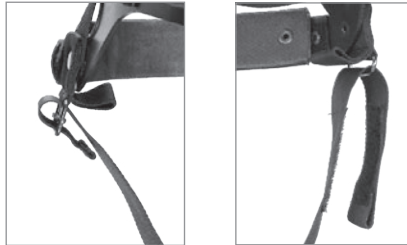

FIGURE 4-7. CHIN STRAP REINSTALLATION

C. Chin Cup Replacement

1. Detach the Velcro tape from the left side of the head-band and remove the chin strap.
2. Slide the chin cup out from the chin strap and replace it with a new one. After replacing the chin cup, attach the Velcro on the left side of the head-band.



FIGURE 4-8. CHIN CUP REPLACEMENT

4.5 SERVICE/PACKING AND UNPACKING

4.5.1 RETURN INSTRUCTIONS

For service, repair or replacements, please email service@armasight.com.

To assist the Service Representative (SR) with determining if the item is repairable, please provide the following information:

1. Serial Number of the defective item.
2. Thorough description of the malfunction, defect or damage.
3. An explanation of how the malfunction, defect or damage occurred, if known.

If the SR determines that the item is under warranty or should be returned for repair, a Return Material Authorization number (RMA#) will be provided. RMA can be obtained via e-mail to service@armasight.com or via phone by calling Armasight Customer Service at (888)959-2259 Ext. 2 or via fax (888)959-2260.

When returning the N-14 for service or repair, the following procedures should be followed to prevent any additional damage:

1. Verify that the N-14 is free of all contaminants such as dirt or any other foreign material.
2. Remove the battery.
3. Place the cap over the lens.
4. Place the N-14 in the hard shipping/ storage case or soft carrying case (if available). If the hard shipping/ storage case is not available, individually package each N-14 unit being returned in a suitable container.

Place the N-14 and a copy of the test report or detailed description of the failure in a suitable packing/ shipping container. Mark the package with the RMA#. Ship the items using the fastest, most easily traceable, prepaid method to Armasight Inc., 815 Dubuque Avenue, South San Francisco, CA 94080, USA.

A. N-14 LIST OF SPARE PARTS

The parts authorized in this list of spare parts are required for operator maintenance. This list includes parts that must be removed in order to replace authorized parts.

ITEM NO. Column indicates the number used to identify items in Figure A-1.

PART NO. Column indicates the primary number used by the manufacturer to identify an item; this number controls the design and characteristics of the item by means of its engineering, specifications, standards, and inspection requirements.

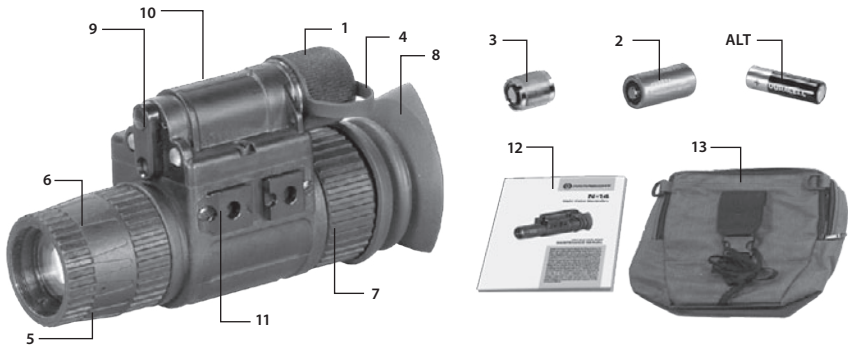

FIGURE A-1. N-14 SPARE PARTS

TABLE A-1. N-14 LIST OF SPARE PARTS

ITEM NO.	DESCRIPTION	PART NO.
1.	Battery Cap	N14BC
2.	CR123A Lithium Battery	CR123A
ALT	AA Alkaline Battery	
3.	Battery Adapter	N14BA
4.	Battery Cap Retainer	N14BCR
5.	Lens Cap	N14LC
6.	Objective Lens Assembly	N14OLA
7.	Eyepiece Assembly	N14EPA
8.	Eyecup Assembly	N14ECA
9.	Pivotal Focusing Lens	N14PFL
10.	Operation button	N14FS

ITEM NO.	DESCRIPTION	PART NO.
11.	Rail	N14PR
12.	Operation and Maintenance Manual	N14OUMM
13.	Soft Carry Case	N14SCC
14.	Shipping/Storage Case	N14SSC

B. INTENSIFIER TUBE REPLACEMENT MANUAL

The intensifier tube can be removed or installed without disassembling the unit's wired housing. Removing or installing the intensifier tube only requires the removal of the eyepiece. The airtight seal will be broken, and the final assembly must be purged with nitrogen to eliminate moisture within the monocular.

B.1 INITIAL SETUP

A. Test Facility

Clean station in the electronic repair service area.

B. Tools

None

C. Materials/Parts

Intensifier Tube

Cotton-tipped applicators

Isopropyl alcohol

WARNING:

The intensifier's phosphor screen contains toxic materials!

- If an intensifier tube breaks, be extremely careful to avoid inhaling the phosphor screen material. DO NOT allow the material to come in contact with the mouth, eyes, or open wounds on the skin.
- If the phosphor screen material contacts your skin, wash it off immediately with soap and water.
- If you inhale or swallow any phosphor screen material, drink a lot of water, induce vomiting, and **seek medical attention as soon as possible.**

NOTE:

Before replacing the intensifier tube, confirm that it is out of the warranty period.

B.2 PROCEDURE OF INTENSIFIER TUBE REPLACEMENT

1. Unscrew the eyepiece (E) from the unit body (A).
2. Unscrew the lock ring (D) from the unit body (A).
3. Extract the light guide (C) from the unit body (A).

CAUTION:

Handle the intensifier tube gently to prevent damage.

Treat any supposedly defective tubes as though they are in good condition so they are not damaged when returned to be reused.

Gently remove the intensifier tube from within the wired housing.

Slowly pull the tube out of the housing in a straight line.

If the intensifier tube is not defective, wrap it in lens paper to protect it and store it in a clean, dry location.

4. Extract the intensifier tube (B) from the body of the unit (A).

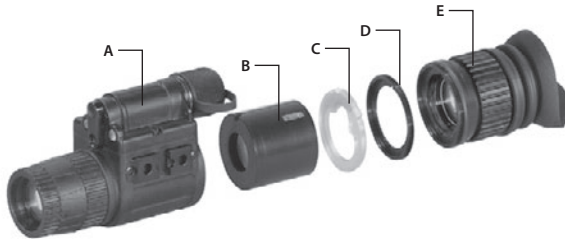

FIGURE B-1. INTENSIFIER TUBE REPLACEMENT

CAUTION:

To avoid damaging the tube, use caution when opening the shipping container.

Treat the defective intensifier tube carefully to avoid damaging it further before returning it.

Only set the intensifier tube down on its contact end.

DO NOT force the intensifier tube into the wired housing of the device.

NOTE:

Retain packaging material for use in returning defective intensifier tubes.

5. Clean both ends of the new intensifier tube with cotton-tipped applicators dampened with isopropyl alcohol.
6. Slide the intensifier tube, contact-end first, into the opening of the wired housing. The groove on the side of the tube should engage the ridge inside the opening of the wired housing.
7. Slide the light guide (C) into place within the body of the unit (A).
8. Screw the lock ring (D) into the body of the unit (A).
9. Screw the eyepiece (E) into the body of the unit (A).

C. PRODUCT WARRANTY REGISTRATION CARD

In order to validate the warranty on your product, Armasight must receive a completed Product Warranty Registration Card for each unit, or the user must complete warranty registration on our website (www.armsight.com). Please complete the included form and immediately mail it to our Service Center: Armasight Inc., 815 Dubuque Avenue, South San Francisco, CA 94080, USA

ARMASIGHT PRODUCT WARRANTY REGISTRATION CARD

PRODUCT INFORMATION

Product Name _____ Purchased From _____

Purchase Date _____ Product Serial # _____

CUSTOMER INFORMATION

Name _____

Address _____

City _____ Country _____ Zip _____

Day Phone # _____ Home Phone # _____

E-mail address _____

.....
Customer Signature Required



Armasight Inc.

815 Dubuque Avenue
South San Francisco
CA 94080, USA

Phone: (888)959-2259

Fax: (888)959-2260

Intl Phone/Fax: (650)492-7755

info@armasight.com

CAUTION:

This product contains natural rubber latex which may cause allergic reactions! The FDA has noted an increase in the number of reported deaths that are associated with an apparent sensitivity to natural latex proteins. If you are allergic to latex, it is a good idea to learn which products contain it and strictly avoid exposure to those products.

www.armasight.com