



iOptron[®] iEQ45 Pro[™] Equatorial Mount Instruction Manual

Product #8000E



This product is a precision instrument. Please read the included QSG before assembling the mount. Please read the entire Instruction Manual before operating the mount.

If you have any questions please contact us at support@ioptron.com



WARNING!

***NEVER USE A TELESCOPE TO LOOK AT THE SUN WITHOUT A PROPER FILTER!
Looking at or near the Sun will cause instant and irreversible damage to your eye.
Children should always have adult supervision while observing.***

Table of Content

Table of Content	3
1. iEQ45 Pro™ German Equatorial Mount Overview.....	5
2. iEQ45 Pro™ Mount Assembly.....	6
2.1. Parts List	6
2.2. Identification of Parts.....	7
2.3. iEQ45 Pro Mount Ports.....	8
2.4. Go2Nova® 8407+ Hand Controller.....	9
2.4.1. Key Description	9
2.4.2. The LCD Screen	10
3. iEQ45 Pro™ Mount Assembly.....	12
3.1. Introduction.....	12
3.2. iEQ45 Pro Mount Assembly	13
3.2.1. STEP 1. Setup Tripod	13
3.2.2. STEP 2. Attaching the Mount.....	13
3.2.3. STEP 3. Setting the Latitude.....	14
3.2.4. STEP 4. Installing the Counterweight (CW) Shaft.....	14
3.2.5. STEP 5. Installing Counterweight(s)	15
3.2.6. STEP 6. Balancing the Payload	15
3.2.7. STEP 7. Connecting Cables.....	16
3.2.8. STEP 8. Setup Hand Controller.....	16
3.2.9. STEP 9. Polar Alignment.....	18
3.2.10. STEP 9. Returning the Mount to Zero Position.....	20
4. Getting Started	21
4.1. Setup the Mount and Polar Alignment.....	21
4.2. Manual Operation of the Mount	21
4.3. One Star Alignment	21
4.4. GOTO the Moon and Other Objects.....	21
4.5. Star Identifying Function	22
4.6. Turn Off the Mount.....	22
5. Complete Functions of Go2Nova® Hand Controller	23
5.1. Slew to an Object.....	23
5.1.1. Solar System	23
5.1.2. Deep Sky Objects.....	23
5.1.3. Stars:	23
5.1.4. Comets	23
5.1.5. Asteroids	23
5.1.6. Constellations.....	24
5.1.7. Custom Objects.....	24
5.1.8. Custom R.A. DEC.....	24
5.2. Sync to Target.....	24
5.3. Alignment	24
5.3.1. Pole Star Position.....	24
5.3.2. One Star Alignment	24
5.3.3. Two Star Polar Align	25
5.3.4. Three Star Align.....	25
5.3.5. Solar System Align.....	25
5.3.6. Polar Iterate Align.....	25
5.3.7. View Model Error.....	25

5.3.8. Clear Alignment Data	26
5.4. Settings.....	26
5.4.1. Set Time and Site	26
5.4.2. Set Beep	26
5.4.3. Set Display	26
5.4.4. Set Guiding Rate	26
5.4.5. Set Tracking Rate.....	27
5.4.6. Set Parking Position.....	27
5.4.7. Meridian Treatment	27
5.4.8. Track Below Horizon.....	27
5.4.9. Set Eyepiece Light	27
5.4.10. HBX Heating OFF/ON	28
5.4.11. Language.....	28
5.4.12. Enter Alt-Azi Mode (or Enter EQ Mode).....	28
5.5. Electric Focuser	28
5.6. PEC Option	28
5.6.1. Record PEC.....	28
5.6.2. PEC Data Integrity	28
5.7. Park Telescope	29
5.8. Edit User Objects	29
5.8.1. Enter a New Comet.....	29
5.8.2. Enter Other Objects or Observation List	29
5.9. Firmware Information.....	30
5.10. Zero Position.....	30
5.10.1. Goto Zero Position.....	30
5.10.2. Set Zero Position.....	30
6. Maintenance and Servicing.....	31
6.1. Maintenance.....	31
6.2. iOptron Customer Service.....	31
6.3. Product End of Life Disposal Instructions.....	31
6.4. Battery Replacement and Disposal Instructions	31
Appendix A. Technical Specifications	32
Appendix B. iEQ45 Pro Go2Nova [®] 8407+ HC MENU STRUCTURE.....	33
Appendix C. Firmware Upgrade.....	36
Appendix D. Computer Control an iEQ45 Pro Mount	37
Appendix E. Go2Nova [®] Star List.....	38
IOPTRON TWO YEAR TELESCOPE, MOUNT, AND CONTROLLER WARRANTY	45

1. iEQ45 Pro™ German Equatorial Mount Overview

The iEQ45 Pro™ GOTO German equatorial mount is one of the next generation premium astro-imaging mounts from iOptron. Based on the success of iEQ45 mount, the iEQ45 Pro mount uses high resolution, low noise stepper motor with higher gear ratio to offer better GOTO and tracking accuracy. The mount is made of the highest quality materials to ensure stability and durability. With a payload of 45 lb (20 kg) balanced – it comes standard with a calibrated dark field illumination polar scope and a sturdy 2-inch stainless steel tripod. It also fits both Vixen and Losmandy-type mounting plates. Its lighter weight (only 25 lb or 11.4 kg) makes it much easier to carry.

Features:

- Specialized astrophotography mount ideal for entry-level and intermediate astrophotographers
- Portable, compact, and sturdy German equatorial mount with the highest Payload/Mount ratio (1.7) in the category
- Payload: 45 lb (20 kg) (excluding counterweight)
- Mount weight: 25 lb (11.4 kg)
- Ultra-accurate tracking with temperature-compensated crystal oscillator (TCXO)
- FlexiTouch™ Gap-free structure for both R.A. and DEC worm gears
- Resolution: 0.09 arc second
- Go2Nova® 8407+ controller with Advanced GOTO NOVA® GoTo Technology
- Permanent periodic error correction (PEC)
- Built-in 32-channel Global Positioning System (GPS)
- Integrated ST-4 compatible autoguiding port
- AccuAlign™ polar scope with dark-field illumination™ and Quick Polar Alignment procedure, allowing fast and accurate polar alignment
- BrightStar Polar Alignment routine for those who can't see the Pole Star
- iOptron port for electronic focuser, laser pointer, planetary dome control
- RS232 port for computer control via ASCOM platform
- Heated hand controller for low temperature operation (as low as -20°C)
- Spring loaded Vixen/Losmandy dual saddle
- 2 inch heavy-duty stainless steel tripod, with optional 42" or 48" tall pier, or new Tri-pier
- Die-cast metal tripod spreader with accessory tray
- Optional counterweight extension shaft (#8026)
- Optional carrying case (#8080)
- Optional PowerWeight™ rechargeable battery pack (#8128)
- Optional AZ base (#8050) to convert it to an AltAzimuth mount.

2. iEQ45 Pro™ Mount Assembly

2.1. Parts List¹

There are three shipping boxes for an iEQ45 Pro mount (#8000E). One box contains an EQ mount, an 8407+ hand controller and a Vixen/Losmandy dual dovetail saddle (attached to the mount). One Box for 2" tripod. One box contains two 11lb (5kg) counterweights (CWs) and accessories. There will be a forth box for an iEQ45 Pro AZ mount. The contents are:

- iOptron iEQ45 Pro telescope mount (#8200E) or iEQ45 Pro telescope mount with hard case (#8200E-HC)
- Accessories (#8020DA)
 - 5kg counterweight X2
 - 6P6C RJ11 (6 pin connector, straight wired) coiled controller cables X2
 - Illuminating LED with cable
 - AC adapter (100V~240V)
 - 12V DC adapter cable with car lighter plug
 - 4P4C RJ9 (4 pin connector) to DB9 RS232 serial cable for firmware upgrade and computer control.
 - Azimuth locking screws X3
- Tripod (#8021ACC)/42 inch pier (#8033)/48 inch pier (#8030)
- AZ option (#8050)
- Quick Start Guide

OPTIONAL PARTS

- 42 inch pier (#8033) /48 inch pier (#8030)
- Tri-Pier (#8034)
- Counterweight extension shaft (#8026)
- Carrying case (#8080)
- MiniPier (#8032)
- StarFi wireless adapter (#8434)
- USB to RS232 Converter with FTDI chipset (#8435)
- PowerWeight™ rechargeable counterweight battery (#8128)

ONLINE RESOURCES (click on the "Support" menu at www.iOptron.com)

- Quick Start Guide
- This instruction manual
- Tips for set up
- Hand controller and mount firmware upgrades (check online for latest version)
- ASCOM driver
- Reviews and feedback from other customers
- Accessories

¹ US market only. Actual contents may vary.

2.2. Identification of Parts

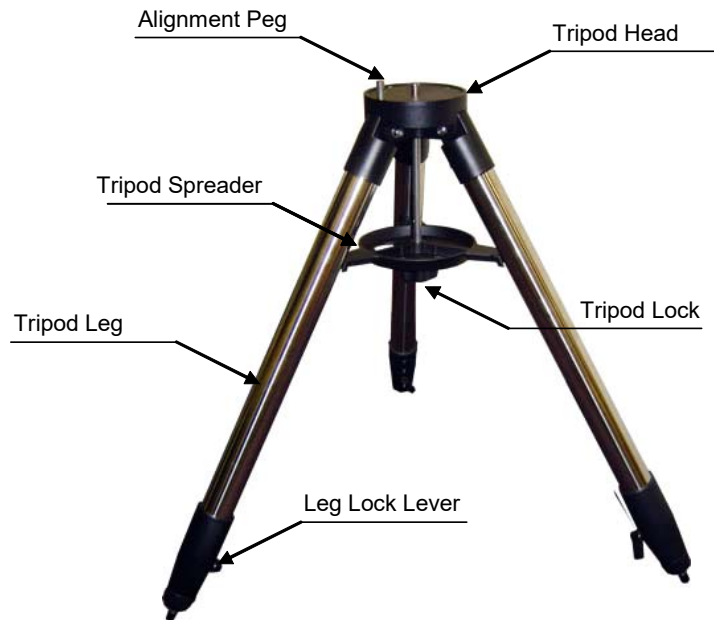
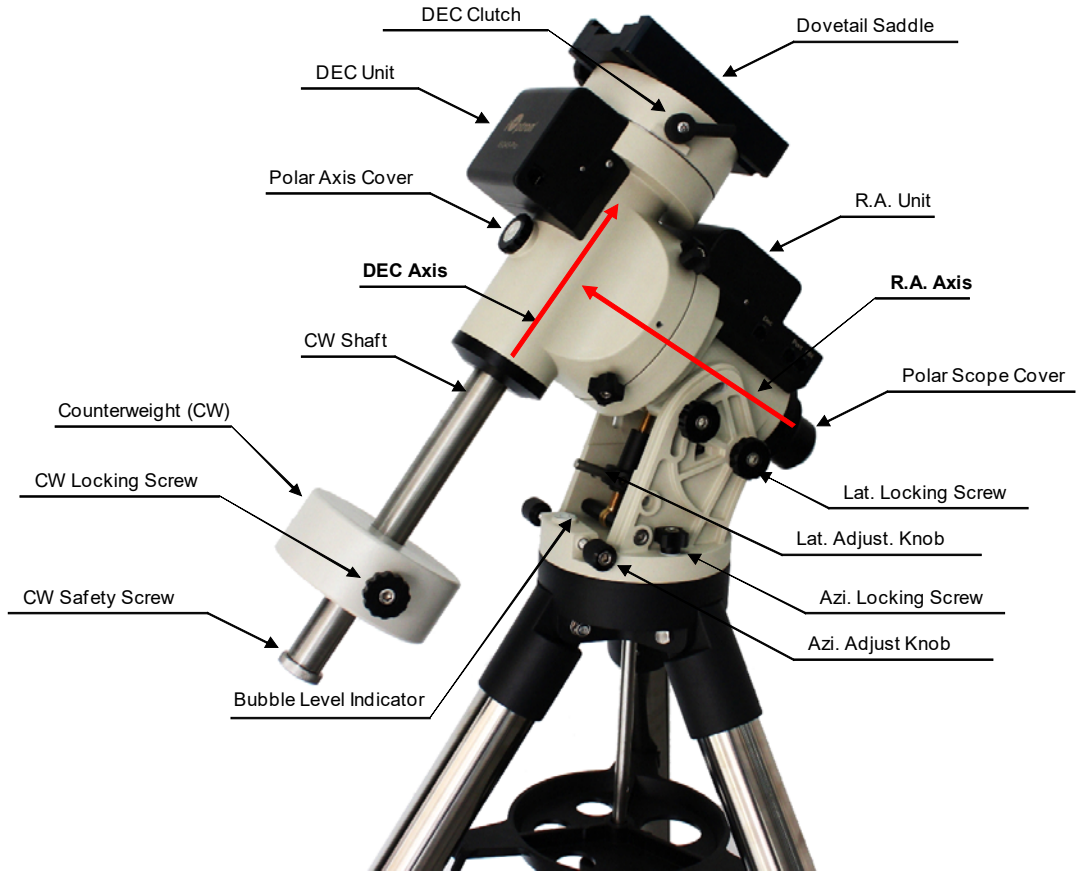

Figure 1. iEQ45 Pro mount assembly

2.3. iEQ45 Pro Mount Ports

Ports on Main Control Unit



Figure 2. Ports on main control unit

- Dec: For connecting to DEC driver unit
- Port: Auxiliary port for connecting to other iOptron accessories, such as an electronic focuser or for observatory dome control. **DO NOT** plug your ST-4 guiding camera cable into this port as it may damage the mount or guide camera electronics.
- HBX (Hand Box): For connecting to an 8407+ Hand Controller
- Reticle: Power supply for the polar scope illuminated reticle LED, or illuminated eyepiece
- DC 12V: DC power socket to power the mount (2.1mmX5.5mm, center positive)
- POWER: Power switch
- Guide: ST-4 compatible autoguiding port
- RS232: Serial port (4P4C RJ9 connector) for mount-computer control and firmware upgrade

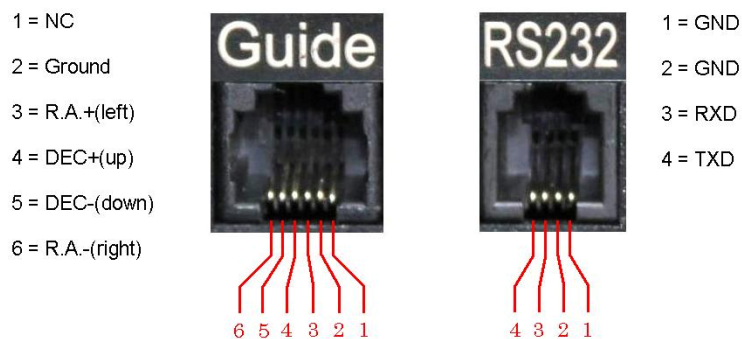

Figure 3. Guide port and RS232 (serial) port pin-out assignment

Port on DEC Unit

The only port on the DEC unit is used to connect to the Dec port on main control unit.

2.4. Go2Nova[®] 8407+ Hand Controller



Figure 4. Go2Nova[®] 8407+ hand controller

The Go2Nova[®] 8407+ hand controller (HC) shown in Figure 4 is the standard controllers that used for the iEQ45 Pro mount. It has an integrated temperature controller that ensures it can be operated as low as -20°C (-4°F). It has a large LCD screen, function, direction and number keys on the front; a red LED reading light on the back; and a HBX port (6-pin) and a serial port (4-pin) at the bottom.

2.4.1. Key Description

- MENU Key: Press “MENU” to enter the Main Menu.
- BACK Key: Move back to the previous screen, or end/cancel current operation, such as slewing.
- ENTER Key: Confirm an input, go to the next menu, select a choice, or slew the telescope to a selected object.
- Arrow (▲▼◀▶) Keys: The arrow keys are used to control the movement of DEC and R.A. axes. Press and hold ▲(DEC+), ▼(DEC-) buttons to move a telescope along the DEC direction, ◀(R.A.+), ▶(R.A.-) to move a telescope along the RA direction. They are also used to browse the menu or move the cursor while in the menu. Press and holding an arrow key for a fast scrolling.
- Number Keys: Input numerical values. Also used to adjust speeds (1: 1X; 2: 2X; 3: 8X; 4: 16X; 5: 64X; 6: 128X; 7: 256X; 8: 512X; 9: MAX)
- Light Key(☀): Turns on/off the red LED reading light on the back of the controller.
- Help (?) Key: Identify and display bright stars or objects where the telescope points to.
- STOP/0 Key: Stop the mount during GOTO. Also toggling between start and stop tracking.
- HBX (Handbox) port: connect the HC to the iEQ45 Pro mount using a 6P6C RJ11 cable.

- Serial port (*i.e.*, RS232 port): connect the HC to a Computer for HC firmware upgrade via a RS232-RJ9 cable.

2.4.2. The LCD Screen

The 8407+ HC has a large 8-line, 21-character per line LCD screen, which displays all the information as shown in Figure 5. The user interface is simple and easy to operate.

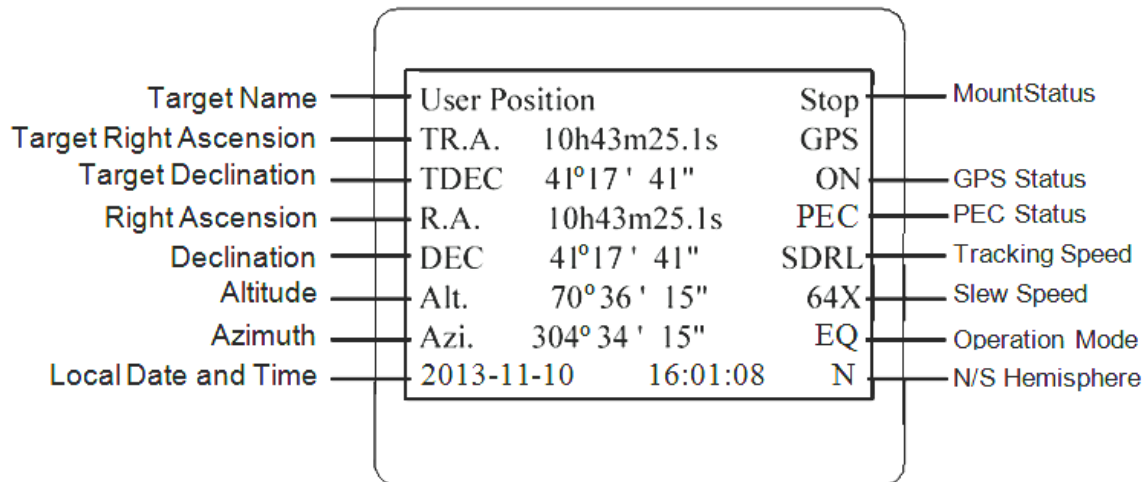

Figure 5. 8407+ HC LCD Information Screen

1. Target Name/Mount Position: displays the name of the target that telescope is currently pointed to or the current mount position.
 - Zero Position: The reference position for the mount. It will be displayed when moved to Zero Position using "**Goto Zero Position**";
 - User Position: The mount is point to a user defined position, which could be a particular celestial object or simply a position determined by pressing an arrow key;
 - An object name, such as "Mercury" or "Andromeda Galaxy": Name of the star or celestial object that the mount is currently slewing to or tracking.
2. Target R.A.: Right Ascension (R.A.) of the target object.
3. Target Declination: Declination (DEC) of the target object.
4. Right Ascension: Current R.A. of the telescope.
5. Declination: Current DEC of the telescope.
6. Altitude: Altitude of the telescope (degrees vertical from the local horizon - zenith is 90°).
7. Azimuth: Azimuth of the telescope (north is 0°, east 90°, south 180°, and west 270°).
8. Local Date and Time: display local time in a format of YY-MM-DD HH:MM:SS.
9. Mount Status: Display current operation status of the mount.
 - Stop: mount is not moving;
 - Slew: mount is moving with an arrow key is pressed or a GOTO command, such as "**Select and Slew**" or "**Goto Zero Position**";
 - Tracking: mount is at a tracking status.
10. GPS status: When the power is turned on, the initial GPS status will be "GPS ON", which means that the mount is connected to its GPS receiver and is seeking a satellite signal. When the GPS receiver finds the satellites and receives the GPS signal, the status will change to "GPS OK".
11. PEC status: Display of "PEC" here Indicates the Periodic Error Correction playback is turned on.
12. Tracking speed: Display current tracking rates of the mount
 - SDRL: mount is tracking at a sidereal speed;

- Solar: mount is tracking at a solar speed;
 - Lunar: mount is tracking at a lunar speed;
 - King: mount is tracking at a King speed;
 - CSTM: mount is tracking at a customer defined speed.
13. Slew speed: It has 9 speeds: 1X, 2X, 8X, 16X, 64X, 128X, 256X, 512X, MAX (1400X, ~5.8°/sec).
14. Operation Mode: EQ indicates that the mount is operating in an equatorial mode. AA is for alt-azimuth mode.

3. iEQ45 Pro™ Mount Assembly

3.1. Introduction

Congratulations! You have just purchased a new design of telescope mount that has a class leading payload capacity for its weight and is capable of high precision tracking. This makes the iEQ45 Pro a superb choice for observational astronomy and astrophotography whether permanently mounted on a pier, in an observatory, or as part of a portable setup for use in your backyard, at dark sky sites, and at star parties.

In order for you to get the optimum performance from the mount and your optical tube assembly (OTA) combination, you must assemble and set up the mount correctly.

The following basic principles are included to help you understand the fundamental concepts of telescope mounts before the specific details of the iEQ45 Pro mount are covered.

Telescope mounts are either equatorial or altitude-azimuth (Alt-Az). Both types of mount rotate the OTA around two perpendicular axes to point to a desired object in the night sky.

An Alt-Az is a simple mount that has a horizontal axis to provide vertical (altitude) OTA movement from the local horizon and a vertical axis to provide horizontal (azimuth) OTA movement and is therefore able to point at any part of the sky. In order to track an object across the sky, an Alt-Az mount has to continually move the OTA in both axes. This can provide tracking that is good enough for visual observing and short exposure photography. However, the mechanics of this system are such that an OTA carried by an Alt-Az mount will suffer from field rotation where stars will appear to rotate about the point being tracked forming arcs. As such Alt-Az mounts are not suitable for long exposure astrophotography which is needed to capture faint deep sky objects.

An equatorial mount has an axis, called the right ascension (R.A.) axis, aligned with the celestial North Pole (CNP) in northern latitudes, or the celestial South Pole (CSP) in the Southern Hemisphere. Equatorial mounts counteract the rotation of the Earth by driving the R.A. axis in the opposite direction thus tracking celestial objects as they appear to move across the sky. Once the mount has been accurately aligned to the celestial pole, only movement of the R.A. axis is required for accurate tracking and this design does not suffer from field rotation. R.A. is the celestial equivalent of longitude and is the angular distance measured eastward along the celestial equator as measured from a zero reference point (the vernal equinox). A second axis perpendicular to the R.A., the declination axis (DEC), provides elevation relative to the celestial equator.

As mentioned above, in order to track celestial objects the R.A. axis of an equatorial mount must be accurately aligned with the celestial pole. Your new iOptron mount comes equipped with features that make accurate alignment quick and easy. The iEQ45 Pro includes mechanical adjusters that move the mount in altitude and azimuth in order to align the R.A. axis, also known as the mount's Polar Axis, with the celestial pole. These adjustments do not involve any rotation of the mount's R.A. or DEC axes and can be performed without the OTA installed. The first step is to make an approximate azimuth alignment of the mount's Polar Axis by roughly aligning the R.A. axis to a reference point toward True North (or True South if in the Southern Hemisphere). A compass can be used for this initial azimuth alignment but you must allow for the variation between True and Magnetic North/South at your location. Precise horizontal alignment of the Polar Axis is accomplished with the azimuth adjustment bolts on the mount. The second step is to adjust the Polar Axis vertically (altitude) above the horizon by setting the observer's latitude on the provided latitude scale. This procedure is based on the fundamental geometry of the Earth's coordinate system in conjunction with the concept of the celestial sphere. You can verify this by visualizing yourself at the North Pole (latitude N90°) in which case Polaris will be 90° from the horizon, or directly overhead. These steps will place the Polar Axis very close to the celestial pole. The accuracy of both of the above adjustments can be enhanced by the use of the incorporated polar scope, which sits in an opening along the R.A. axis and allows direct viewing of the pole. In order to get the most out of your equatorial mount it is essential to understand the concept of polar alignment and how the equatorial mount helps you establish and maintain a true Polar Axis alignment. Now you are ready to set up the GOTO functionality of the iEQ45 Pro mount – which

gives access to more than 300,000 celestial objects – by performing star alignments using the equatorial mount’s electronic controller, and enjoy the night sky.

The iEQ45 Pro mount is a next-generation equatorial mount that provides the precision alignment capabilities required for today’s complete astronomy solution. The following sections of this manual provide the detailed steps required to successfully set up and operate the iEQ45 Pro mount.

3.2. iEQ45 Pro Mount Assembly

NOTE: The iEQ45 Pro is a precision astronomical instrument. It is highly recommended that you read the entire manual and become familiar with the nomenclature and function of all components before starting the assembly.

3.2.1. STEP 1. Setup Tripod

Expand the tripod legs and install the Tripod Spreader using the Tripod Lock as shown in Figure 6. Tightening the Tripod Lock will expand the tripod legs fully and provide maximum support for the mount and the Optical Tube Assembly (OTA). Adjust the tripod height by unlocking the tripod Leg Lock Levers, sliding the lower tripod leg to the desired length, and relocking the tripod Leg Lock Screws. It is recommended that you extend the legs fully during the first assembly and modify the length as required in subsequent adjustments. After the legs are adjusted and locked, stand the tripod with the Alignment Peg facing True North. If you are located in the southern hemisphere, face the Alignment Peg True South.

CAUTION: If the latitude of your location is below 20°, you may move the Alignment Peg to the opposite position to prevent the counterweights from hitting the tripod legs. If the latitude is below 10°, a pier (#8030, 48” tall or #8033, 42” tall) is recommended in place of a tripod. Or you may add a MiniPier (#8032). The mount can also be specially modified for the application near the equator.



Figure 6 Tripod

3.2.2. STEP 2. Attaching the Mount

Tighten the two (2) R.A. clutch screws. Carefully remove the mount from the shipping box and tighten the other two (2) R.A. clutch screws on the other side. Familiarize yourself with the components shown in Figure 1.

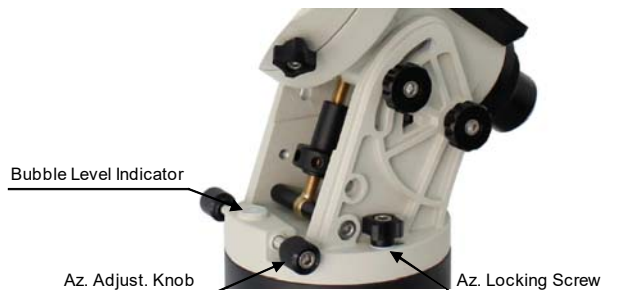

Figure 7



Figure 8

Back out the Azimuth Adjustment Knobs (next to the Bubble Level Indicator) to prevent blocking the Alignment Peg (Figure 7). Put the mount onto the tripod head (or pier top) with bubble level on top of the Alignment Peg (Figure 8). Secure the mount head by tightening Azimuth Locking Screws. Level

the mount by adjusting individual tripod leg (or pier foot). You may use the build-in Bubble Level Indicator or an external level to check leveling.

3.2.3. STEP 3. Setting the Latitude

Unlock the four R.A. Clutch Screws and rotate the mount 180° around the R.A. axis (Figure 9) to move the dovetail face upside. Tighten the R.A. Clutch Screws. Unscrew the Latitude Adjustment Lever from Latitude Adjustment Knob (Figure 10). Turn the Latitude Adjustment Knob to set your current latitude, which is displayed in Latitude Mark Window. Use the Lever for fine adjustments as needed. You may set the latitude without the load for an easy adjustment.

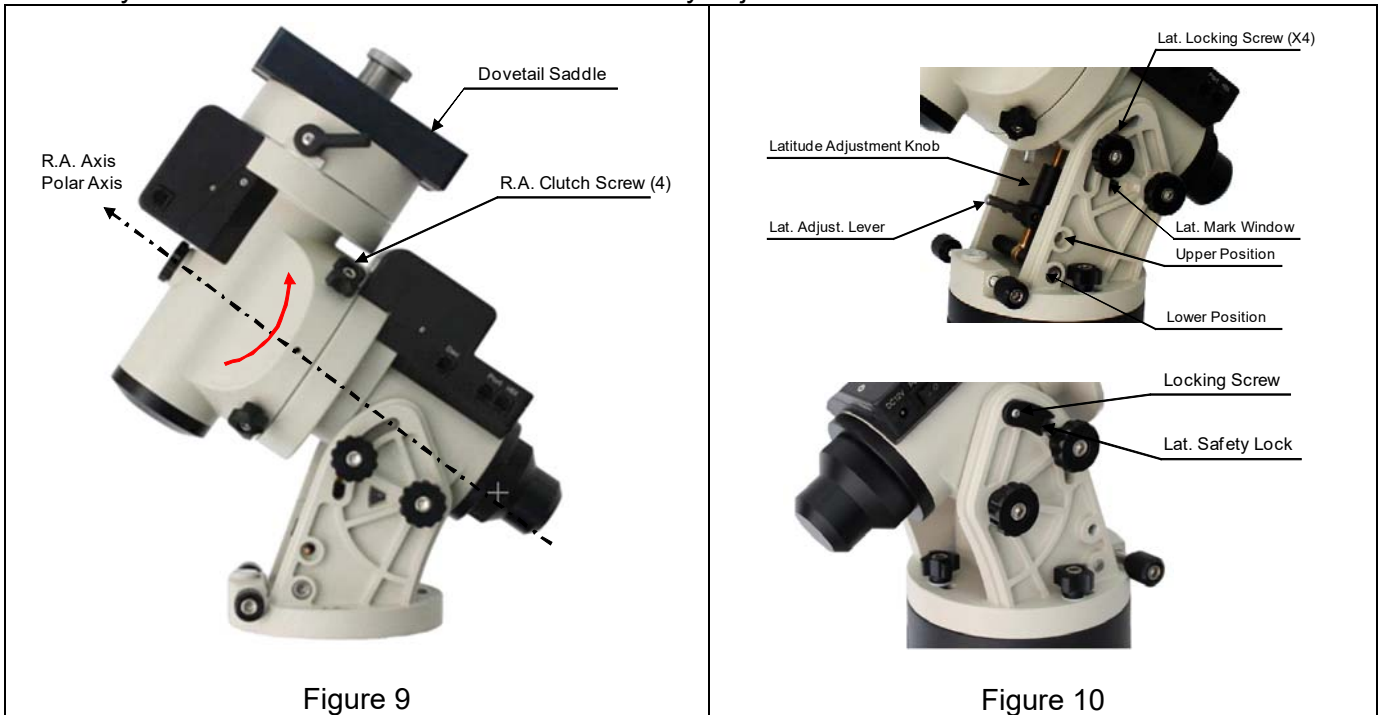

The factory default position is set at 5° to 40°. A Latitude Safety Block has to be installed for low latitude setting (Figure 10)

If your latitude is between 35° to 70°, set the Latitude Adjustment Knob to the upper position. Take the Latitude Safety Block off. Set the Latitude Adjustment Knob to the upper position. You should change the position before attaching the mount to the tripod head.

3.2.4. STEP 4. Installing the Counterweight (CW) Shaft

Unscrew the CW shaft from the top of the mount as shown in Figure 11(a) and thread it into the opening of the DEC axis as shown in Figure 11(b).

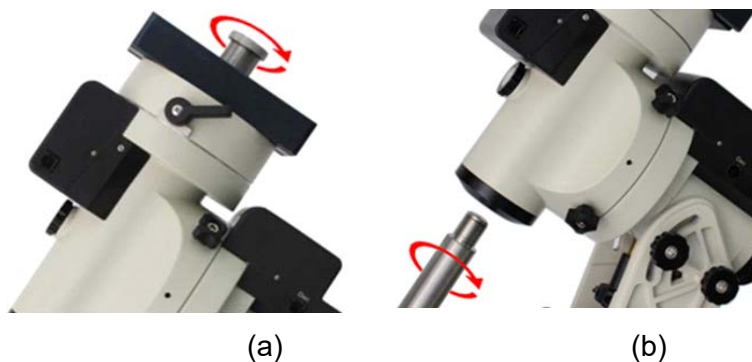

Figure 11

3.2.5. STEP 5. Installing Counterweight(s)

iEQ45 Pro mount comes with two 11lb (5kg) counterweights (CWs). Use one or both CWs as required for your particular OTA. Additional CW(s) or shaft extension bar may be needed to balance a heavier OTA.

Before installing the counterweight, make sure that both R.A. and DEC clutches are fully engaged to avoid sudden mount movements which could cause injury and/or damage the mount gear system and your equipment.

Make sure the mount is at the zero position (i.e. counterweight shaft is pointing to the ground) when installing the counterweight.

Remove the CW Safety Screw on the end of the CW shaft. Guide the CW over the shaft and tighten the CW Locking Screw to hold the CW in place. Always place the Safety Screw back onto the shaft prior to use to prevent personal injury and/or equipment damage. Lock four R.A. Clutch Screws again.



WARNING: The mount should always be kept in the zero position while it is being loaded with CWs and payload.



WARNING: The zero position is the only safe position the mount should stay in unless it is balanced.

Optional CW shaft extension, as shown in Figure 12(b) or extra counterweight(s) are available for purchase for those the payload (payload torque, more precisely) exceeds the equipped CWs.



Figure 12

3.2.6. STEP 6. Balancing the Payload

After attaching the scope and accessories, the mount must be balanced in both R.A. and DEC axes to ensure minimum stress on the mount driving mechanism. There are four (4) Clutch Screws on R.A. axis and one Clutch Handle on DEC axis. Each axis will rotate freely after the related clutch screws are released. The balancing procedure should be performed after the CWs, OTA, and all accessories are installed.



WARNING: The telescope will swing when the R.A. and DEC clutch screws or handle are released. Always hold on to the telescope assembly before releasing the clutch screws or handle to prevent it from swinging, which can cause personal injury and/or equipment damage.

Only balance one axis at a time and start with the DEC axis first. Double check the mount to make sure both the R.A. and DEC axes are balanced.

Balance the mount in DEC axis

Release the four (4) R.A. Clutch Screws and rotate the R.A. axis to place the DEC axis in the horizontal position, as shown in Figure 13(a), and then tighten the R. A. Clutch Screws. The OTA can be on either side. Then release the DEC Clutch Handle and rotate the OTA to a horizontal position as shown in Figure 13(b). If the OTA has a tendency to rotate about the DEC axis, you will have to slide

the OTA forward or backward to balance it in the horizontal position about the DEC axis. When the OTA is balanced horizontally, tighten the DEC Handle.

Balance the mount in R.A. axis

Release the four (4) R.A. Clutch Screws. If the DEC axis stays in the horizontal position, as shown in Figure 13(a), it means the R.A. axis is balanced. Otherwise, release the CW Locking Screw and move the CW as required to balance the R.A. axis. Tighten the CW Locking Screw.



Figure 13

3.2.7. STEP 7. Connecting Cables

Attach one RJ11 connector of a coiled cable into the socket on the side of the DEC unit and the other end into the DEC socket located on the main control unit. Use another coiled cable to connect the hand controller to the HBX socket located on the main control unit. **DO NOT plug the cable into Port or Guide port.** Plug the 12V DC power supply into the Power socket on the main control unit. The red LED will be on when the power switch is turned on.

3.2.8. STEP 8. Setup Hand Controller

The iEQ45 Pro mount is equipped with a GPS receiver which will receive the time, longitude and latitude information for your current location from satellites after a link is established. However, there are still some parameters which need to be entered to reflect your location, such as time zone information and whether daylight saving time is currently in effect. This information will be stored in the hand controller memory along with longitude and latitude coordinates until they need to be updated.

A clear sky and open space outside is needed for the GPS to establish a link with the satellites. The GPS is installed on the top of the main board under main control board cover. If the GPS module has difficulty receiving the satellite signal, you may rotate the R.A. axis to one side to exposure the GPS module.

To set up the controller, press **MENU =>“Settings”**

```
Select and Slew
Sync. to Target
Alignment
Settings
Electric Focuser
PEC Options
Park Telescope
Edit User Objects
```

Press **ENTER** and select **“Set Time and Site”**

```

Set Time & Site
Set Display and Beep
Set Guiding Rate
Set Tracking Rate
Set Parking Position
Meridian Treatment
Tracking Below Horizon
Set Eyepiece Light

```

Press **ENTER**. A time and site information screen will be displayed:

```

2014-03-09 10:19:18
Daylight Saving Time    Y
UTC -300 Minute(s)

Longitude:W071d08m50s
Latitude:  N42d30m32s

Northern Hemisphere

```

Set Local Time

The time will be updated automatically when the GPS receiver has established its link with the GPS satellites. In the event that the GPS module is unable to establish a link to the satellites, local time can be entered manually. Use the ◀ or ▶ key to move the cursor █ and use the number keys to change the numbers. Use the ▲ or ▼ button to toggle between “Y” and “N” for Daylight Saving Time, or “+” and “-” for UTC (Coordinated Universal Time) setting. Hold the arrow key to fast forward or rewind the cursor.

In order to make the Hand Controller reflect your correct local time, **time zone information has to be entered**. Press the ◀ or ▶ key, move the cursor to the third line “**UTC -300 Minute(s)**” to set the time zone information (add or subtract 60 minutes per time zone). For example:

- Boston is “UTC -300 minutes”
- Los Angeles is “UTC -480 minutes”
- Rome is “UTC +60 minutes”
- Beijing is “UTC +480 minutes”
- Sydney is “UTC +600 minutes”

All the time zones in North America are “UTC -”, as shown in the following table, so ensure the display shows “**UTC -**” instead of “**UTC +**” if in North or South America.

Time Zone	Hawaii	Alaska	Pacific	Mountain	Central	Eastern
Hour behind UT	-10	-9	-8	-7	-6	-5
Enter UTC	-600	-540	-480	-420	-360	-300

To adjust minutes, move the cursor to each digit and use the number keys to input the number directly. Use ▲ or ▼ key to toggle between “+” and “-”. After the time zone information is entered, press ENTER and go back to the previous screen. **Note that fractional time zones can be entered.**

Do not manually add or subtract an hour from displayed time to reflect Daylight Saving Time (DST). Only select “Y” after DST begins.

For other parts of the world you can find your “time zone” information from the internet.

Set Observation Site Coordinate

The third and fourth lines display the longitude and latitude coordinates respectively. The longitude and latitude coordinates will be automatically updated when the GPS picks up a satellite

signal. “W/E” means Western/Eastern Hemisphere; “N/S” means Northern/Southern Hemisphere; “d” means degree; “m” means minute; and “s” means second.

If, for any reason, your GPS does not pick up the satellite signal, you can manually enter your longitude and latitude coordinates. Press the ◀ or ▶ key to move the cursor, use the ▲ or ▼ key to toggle between “W” and “E”, and “N” and “S”, and use the number keys to change the numbers. It is always a good idea to do your homework and get longitude and latitude coordinates before traveling to a new observation site.

The site coordinates information can be found from your smart phone, GPS receiver or via the internet. Site information in decimal format can be converted into d:m:s format by multiplying the decimal numbers by 60. For example, N47.53 can be changed to N47°31'48": $47.53^\circ = 47^\circ + 0.53^\circ$, $0.53^\circ = 0.53 \times 60' = 31.8'$, $0.8' = 0.8 \times 60'' = 48''$. Therefore, $47.53^\circ = 47^\circ 31' 48''$ or 47d31m48s.

Select N/S Hemisphere

If the polar axis is aligned to the North Celestial Pole, then set the mount to Northern Hemisphere. If the polar axis is pointing to the South Celestial Pole, set the mount to Southern Hemisphere. Press the ◀ or ▶ key to move the cursor and use the ▲ or ▼ key to toggle between “Northern Hemisphere” and “Southern Hemisphere”.

As an example, select Northern Hemisphere if you are located in US and press **ENTER** to go back to the main menu.

The time and site information will be stored inside the hand controller’s memory chip. If you are not traveling to another observation site, they do not need to be changed.

Check the Battery

The hand controller has a real time clock (RTC) which should display the correct time every time the mount is turned on. If the time is incorrect, please check the battery inside the hand controller and replace it if needed. The battery is a 3V, CR1220 button battery.

3.2.9. STEP 9. Polar Alignment

In order for an equatorial mount to track properly, it has to be accurately polar aligned. With iOptron innovative Polar Scope and Quick Polar Alignment procedure, you can do a fast and accurate polar axis alignment.

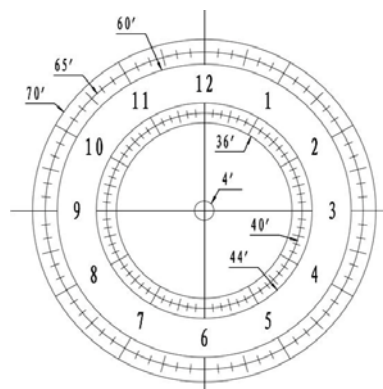

Figure 14. Polar Scope Dial

As indicated in Figure 14, the Polar Scope reticle has been divided into 12 hours along the angular direction with 10 minute tics. There are 6 concentric circles in 2 groups of 3 marked from 36' to 44' and 60' to 70', respectively. The 36' to 44' concentric circles are used for polar alignment in

Northern Hemisphere using Polaris, while the 60' to 70' circles are used for polar alignment in Southern Hemisphere using Sigma Octantis.

Quick Polar Alignment

- (1) Level the iEQ45 Pro mount. Make sure the telescope optical axis is parallel to the polar axis (R.A. axis) of the mount. If using a finder scope, adjust it to be parallel to the telescope optical axis. Remove both the Polar Axis Cover and Polar Scope Cover.
- (2) Thread the polar LED into the threaded hole located on the Polar Scope. Connect one end of the polar scope power cable to the illumination LED and the other end to the Reticle socket located on main control board. Turn the mount power on. Use the Hand Controller (“**Settings**” => “**Set Eyepiece Light**”) to set the illumination intensity.
- (3) Use the ▲ or ▼ key to turn the DEC axle to unblock the Polar Scope view.
- (4) Adjust polar scope eyepiece shown in Figure 15 to bring the polar scope dial in focus.
- (5) Use the ◀ or ▶ key to adjust polar scope dial to ensure that 12 o'clock is at the top. If the polar scope is equipped with a bubble level indicator, you may use the bubble as the reference. You may release four R.A. clutch screws and hold the OTA while rotate the Polar Scope. It is also convenient to rotate the polar scope before loading the CW and OTA.

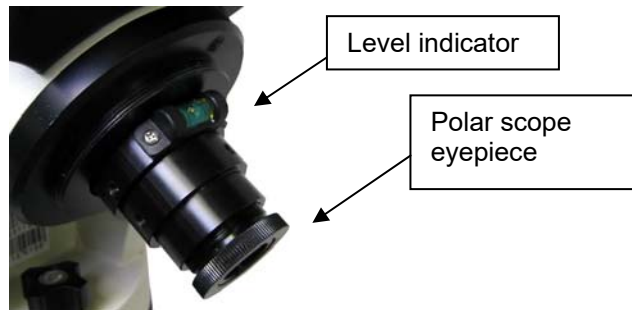

Figure 15. Polar scope with bubble level indicator

- (6) Use the Hand Controller (**MENU** => “**Alignment**” => “**Pole Star Position**”) to display the current position of Polaris on the LCD screen, as indicated in the left side of the figure below. For example, on June 22, 2014, 20:19:42 in Boston, US (alt N42°30’32” and long W71°08’50”), 300 min behind UT, the Polaris Position is 0h45.8m and 40.4m.
- (7) Look through the polar scope to find the Polaris. Use the Azimuth and Latitude Adjustment Knobs to adjust the mount in both directions and put the Polaris in the same position on the Polar Scope reticle as indicated on the HC display screen. In this case, Polaris will be located at a radius of 40.4 minutes and an angle of 0h 45.8 minutes, as shown in Figure 13 (b).

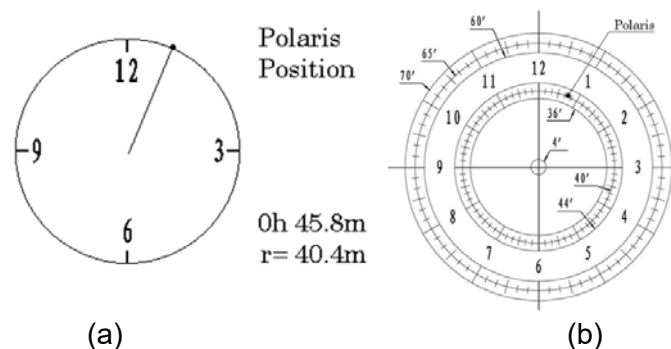

Figure 16. Polaris Position shown on HC (a) and where to put on polar scope reticle (b)

NOTE: Thread the polar scope eyepiece all the way in after polar alignment, before put the Polar Scope Cover back on. Otherwise, the polar scope eyepiece could be stuck inside the Polar Scope Cover to cause R.A. axis jamming.

NOTE: If you are located in the Southern Hemisphere, Sigma Octantis will be chosen for Polar Alignment. For example, on May 20, 2010, 20:00:00 in Sydney, Australia (Lat. S33°51'36" and Long.E151°12'40"), 600 min ahead of UT, the position of Sigma Octantis is located at a radius of 64.4 minutes and an angle of 1hour21.8minutes.

BrightStar Polar Alignment

For those who can't see the pole star, you can use BrightStar Polar Alignment procedure described in 5.3.6, ***Polar Iterate Align.***

3.2.10. STEP 9. Returning the Mount to Zero Position

Return the mount to the Zero Position after balancing, i.e. with the CW Shaft pointing to the ground and the telescope aperture at its highest position, as shown in Figure 17. Press **MENU=>Zero Position =>Set Zero Position** to set the mount zero position.

Always set or check the zero position before each use or after firmware upgrade.



Figure 17. Zero position

4. Getting Started

In order to experience the full GOTO capability of GOTONOVA[®] technology it is very important to set up the mount correctly before observation.

4.1. Setup the Mount and Polar Alignment

Assemble your iEQ45 Pro mount according to Section 3.2. Make sure the mount is leveled. Turn the mount power switch on. When the GPS receiver is connected to satellites, the hand controller LCD will display GPS OK and the mount will have the correct time and site information (this can also be entered manually as previously described). Polar align the mount using the **Quick Polar Alignment**. Mount an OTA and accessories, and carefully balance the mount on both R.A. and DEC axes. Double check the polar alignment. You may also align your mount after load the OTA and accessories using **BrightStar Polar Alignment Procedure**.

When the mount is powered on, it should be at the Zero Position, i.e. with the counterweight shaft pointing to ground, OTA at the highest position with its axis parallel to the polar axis and the telescope pointing to the Celestial Pole. Press **MENU => "Zero Position" => "Goto Zero Position"** to check if the mount is at zero position. If the mount is not at the Zero Position, press **MENU => "Zero Position" => "Set Zero Position,"** release the R.A. clutch screws and/or DEC clutch lever to adjust the mount to the Zero Position. Follow the hand control to confirm it.

The exception is when the mount is switched on after it was parked before powering off (**MENU => "Telescope Motion" => "Park Scope"**).

4.2. Manual Operation of the Mount

The mount can now be used to observe astronomical objects using the HC. Use the arrow keys (►, ◀, ▼, and ▲) to point the telescope to the desired part of the sky. Use the number keys to change the slewing speed. Press the **STOP/O** button to start tracking.

4.3. One Star Alignment

After setting the mount at zero position, perform a **"One Star Align"** to correct the Zero Position discrepancy.

To perform **"One Star Align,"** press **MENU** button, scroll down to **"Alignment"**, select **"One Star Align"** and press **ENTER**. The hand controller will display details of a bright object. Select a different object using the ▲ or ▼ keys. Then press **ENTER**. After the mount slews to the target, use the arrow keys to center it in your eyepiece. Then press **ENTER**. It can be skipped if this has been done during **Set Zero Position**.

You may use the number key to change the slewing speed to make the centering procedure easier.

4.4. GOTO the Moon and Other Objects

Now the mount is ready for GOTO operation which, using advanced GOTONOVA[®] technology, will automatically slew to, and track, a huge range of celestial targets. We will use the Moon as an example.

Press **MENU** on the hand controller and select **"Select and Slew"**. Select a category, in this example **"Solar System"**, and then select an object of interest, in this case **"Moon"**. Press **ENTER** and the telescope will slew to the object and automatically start tracking. If the target is not centered in your eyepiece, use the arrow keys to center it. Then use **MENU => "Sync to Target"** for better performance.

4.5. Star Identifying Function

The 8407+ hand controller has a star identification function. After setting the correct local time and location and completing polar alignment, slew the telescope to a bright star manually or using the GOTO function. Press the ? key to identify the star that the telescope is pointing to, as well as nearby bright stars if there is any.

4.6. Turn Off the Mount

When you have finished your observation, simply turn the mount power off and disassemble the mount and tripod.

If the mount is set up on a pier or inside an observatory, it is recommended that you return the mount to the Zero Position or park the telescope.

5. Complete Functions of Go2Nova[®] Hand Controller

NOTE: Not all functions are available for altazimuth (AA) mode.

5.1. Slew to an Object

Press the **MENU** button. From the main menu select “**Select and Slew.**” Select an object that you would like to observe and press the **ENTER** key.

The Go2Nova[®] 8407+ hand controller has a database of around 358,000 objects. Use the ► or ◀ buttons to move the cursor. Use the number buttons to enter the number, or the ▼ or ▲ buttons to change a number. Hold a button to fast scroll through the list. The “☉” symbol indicates that the object is above the horizon, and the “☾” symbol means it is below the horizon. In some catalogs the stars below the horizon will not be displayed on the hand controller.

5.1.1. Solar System

There are 9 objects in the Solar System catalog.

5.1.2. Deep Sky Objects

This menu includes objects outside our Solar System such as galaxies, star clusters, quasars, and nebulae.

- Named Objects: consists of 60 popular deep sky objects with their common names. A list of named deep sky objects is included in Appendix E.
- Messier Catalog: consists of all 110 Messier objects.
- NGC Catalog: consists of 7,840 objects
- IC Catalog: consists of 5,386 objects.
- UGC Catalog: consists of 12,921 objects.
- MCG Catalog: consists of 30,642 objects.
- Caldwell Catalog: consists of 109 objects.
- Abell Catalog: consists of 4,076 objects.
- Herschel Catalog: consists of 400 objects.

5.1.3. Stars:

- Named Stars: consists of 195 stars with their common names. They are listed alphabetically; a list is included in Appendix E.
- Binary Stars: consists of 210 binary stars; a list is attached in Appendix E.
- GCVS Variable Stars: consists of 38,528 GCVS variable stars; they are listed numerically.
- SAO Catalog: consists of 258,997 SAO catalog objects; they are listed numerically.

5.1.4. Comets

This catalog contains 15 comets.

5.1.5. Asteroids

This catalog contains 116 asteroids.

5.1.6. Constellations

This catalog consists of 88 modern constellations with their names. They are listed alphabetically; a list is attached in Appendix E.

5.1.7. Custom Objects

This allows the storage of up to 60 user-defined objects, including comets.

5.1.8. Custom R.A. DEC

Here you can go to a target by entering its R.A. and DEC coordinates.

5.2. Sync to Target

This operation will match the telescope's current coordinates to the Target Right Ascension and Declination. It can be used to correct GOTO pointing error. After slewing to an object, press **MENU** - then scroll to "**Sync to Target**" and press **ENTER**. Follow the screen to perform the sync. Using this function will re-align the telescope to the selected object. Multiple syncs can be performed if needed. This operation is useful to find a faint star or nebula near a bright star.

"**Sync to Target**" will only work after "**Select and Slew**" is performed. You can change the slew rate to make the centering procedure easier. Simply press a number (1 through 9) key to change the speed. The default slew rate is 64x.

"**Sync to Target**" will improve the local GOTO accuracy near by the synced star, which is useful for finding a faint object nearby.

5.3. Alignment

This function is used for aligning the telescope to the celestial pole and to create a sky model to calibrate the mount's GOTO[®] functionality.

The hand controller provides two polar alignment methods. "**Polar Align**" uses a set of 2 bright stars for polar alignment providing a viable polar alignment approach for those who can't see the pole. The "**Two Star Polar Align**" is used to refine the polar alignment using the AccuAlign[™] polar scope.

The system provides three alignment methods to calibrate the mount's GOTO function: "**Solar System Align**", "**One Star Align**", and "**Three Star Align**". The mount has to be at Zero Position before performing any alignment.

5.3.1. Pole Star Position

This function displays the position of the Pole Star for **Quick Polar Alignment** using the iOptron[®] AccuAlign[™] polar scope. In the Northern Hemisphere the position of Polaris is displayed, while in the Southern Hemisphere the position of Sigma Octantis is shown.

5.3.2. One Star Alignment

Press **MENU** => "**Alignment**" => "**One Star Align**". A list of alignment stars that are above the horizon is computed based on your local time and location. With the mount in the Zero Position, use the ▲ and ▼ buttons to select a star and press **ENTER**. Center the target in your eyepiece using the arrow keys. Press **ENTER** when finished. If your mount is set up correctly and polar aligned, one star alignment should be sufficient for good GoTo accuracy. To increase the pointing accuracy over the sky, you may choose to do a three star alignment.

5.3.3. Two Star Polar Align

Two Star Polar Align can improve the accuracy of the mount's polar alignment. Press **MENU** => "**Alignment**" => "**Two Star Polar Align.**" A list of alignment stars that are above the horizon is computed based on your local time and location. With the mount at the Zero Position, use the ▲ and ▼ buttons to select the first alignment star and press **ENTER**. Center the target in your eyepiece using the arrow keys after the mount slews to it. Press **ENTER** when finished. The hand controller will prompt you to choose a second star. After centering the second star, the two-star alignment is finished.

After the two-star alignment, the altitude and azimuth errors will be displayed. This number can be used to fine tune the Quick Polar Alignment.

For example, if the screen shows 7.5" low and 4.3" east, it means that THE MOUNT axis is pointing low and to the east of the Celestial Pole.

5.3.4. Three Star Align

The three-star alignment will further determine the cone error between the OTA and mount axis. The system will use these data to calculate the goto model. If the cone error is big enough, it is suggested to shim the OTA in DEC to minimize it.

Press **MENU** => "**Alignment**" => "**Three Star Align.**" A list of alignment stars that are above the horizon is computed based on your local time and location. With the mount at the Zero Position, use the ▲ and ▼ buttons to select the first alignment star and press **ENTER**. Center the target in your eyepiece using the arrow keys. Press **ENTER** when finished. The hand controller will prompt you to choose a second star. Select third star after the mount aligned to the second star.

The system will display the pointing and cone errors after the three star alignment accepted. The system will update the pointing model accordingly.

5.3.5. Solar System Align

This function uses a planet or the moon as an alignment object. Press **MENU** => "**Alignment**" => "**Solar System Align**" for a list of available alignment objects.

5.3.6. Polar Iterate Align

This alignment method allows you to polar align the mount even if you cannot view the Celestial Pole. Press the **MENU** button, then select "**Alignment**" and "**Polar Iterate Align**". The HC will display a list of bright alignment stars near the meridian as Alignment Star A. Follow the HC instructions to move Alignment Star A to the center of the eyepiece using a combination of the Latitude Adjustment Knob and the "◀" and "▶" buttons. Press **ENTER** to confirm the settings. Next, select a bright star that is close to the horizon as Alignment Star B. Center it using the Azimuth Adjustment Knobs and the "◀" and "▶" buttons (*the "▲" and "▼" buttons will not function*). Press **ENTER** to confirm the settings.

The telescope will now slew back to Alignment Star A to repeat the above steps. The iteration can be stopped when it is determined that the alignment error has been minimized. Press the **BACK** button to exit the alignment procedure.

NOTE: It is highly recommended to use an eyepiece with illuminated crosshairs for accurate centering.

NOTE: The movement of the alignment star in your eyepiece may not be perpendicular depending on its location in the sky.

5.3.7. View Model Error

This will display linear RA error, linear DEC error, polar misalignment, non-perpendicular between OTA and DEC, and non-perpendicular between HA and DEC.

5.3.8. Clear Alignment Data

This will clear all alignment data created during one star, two star or three star alignment process.

5.4. Settings

5.4.1. Set Time and Site

Refer to 3.2.8.

5.4.2. Set Beep

The Hand Controller allows a user to turn off the beep partially, or even go to a silent mode. To change this setting press **"MENU =>Settings =>Set Beep"**,

```
Set Up Time and Site
Set Beep
Set Display
Set Guiding Rate
Set Tracking Rate
Set Parking Position
Meridian Treatment
Tracking Below Horizon
```

Select one of three available modes:

"Always On" – a beep will be heard on each button operation or mount movement;

"On but Keyboard" – a beep will be heard only when the mount is slewing to the object or there is a warning message;

"Always Off" – all sounds will be turned off, including the SUN warning message.

5.4.3. Set Display

Press **"MENU =>Settings =>Set Display"**,

```
Set Up Time and Site
Set Beep
Set Display
Set Guiding Rate
Set Tracking Rate
Set Parking Position
Meridian Treatment
Tracking Below Horizon
```

Use the arrow keys to adjust LCD display contrast, LCD backlight intensity, and keypad's backlight intensity.

5.4.4. Set Guiding Rate

This is an advanced function for autoguiding when a guiding camera is utilized either via a Guide Port or using the ASCOM protocol. Before autoguiding align the polar axis carefully. Select an appropriate guiding speed. The suppositional guiding speed can be selected from $\pm 0.10X$ to $\pm 0.90X$ sidereal rate. Follow the instructions of your autoguiding software for detailed operation.

The guide port wiring is shown in Figure 18, which has same pin-out as that from Celestron / Starlight Xpress / Orion Mount / Orion Autoguider/ QHY5 autoguider.

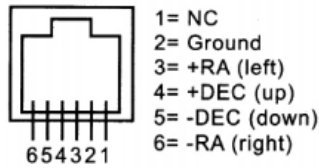

Figure 18. Guide port pin-out

If you have an autoguider which has a pin-out which is the same as the ST-I from SBIG, such as Meade/ Losmandy/ Takahashi/ Vixen, make sure a proper guiding cable is used. Refer to your guiding camera and guiding software for detailed operation.



WARNING: DO NOT plug your ST-4 guiding camera cable into the iOptron port or HBX port. It may damage the mount or guiding camera electronics.

5.4.5. Set Tracking Rate

You can set up the mount tracking rate by selecting “**Set Tracking Rate**”. Then the user can select “**Sidereal Rate**”, “**Lunar Rate**”, “**Solar Rate**”, “**King Rate**”, and “**User Defined Speed**”. The “User defined speed” can be adjusted from 0.9900X to 1.0100X of sidereal.

The “King Rate”, developed by Edward S. King, corrects the tracking rate of a telescope to account for atmospheric refraction. This is more useful for unguided tracking.

5.4.6. Set Parking Position

You may park the telescope before powering off the mount. This is very useful if the mount is on a permanent pier or the mount will not be moved in between observation sessions.

There are four parking positions. “**Default Horizon Pos.**” will park the scope horizontally on the right side of the mount. “**Default Zenith Pos.**” will park the scope vertically on the right side of the mount. “**Current Position**” will park the scope at its current position. Alternatively, you can enter any altitude and azimuth combination for “**Custom Parking Pos.**”. When the mount is parked and turned on, it will use the last parking position setting as the default setting.

5.4.7. Meridian Treatment

This function tells the mount what to do when it tracks past the meridian. You can tell the mount if it needs a meridian flip and when to do it.

- “**Set Position Limit**” will tell the mount when to stop tracking or to do a meridian flip. The limit can be set at from 0° to 15° (1 hour) pass meridian.
- “**Set Behavior**” will tell the mount if a meridian flip will be performed.

5.4.8. Track Below Horizon

This function allows the mount to keep tracking an object even if it is below the horizon but can still be seen, for example from an elevated observation site, such as a hill. The power on default is **Forbidden**. One can turn it on when needed.

5.4.9. Set Eyepiece Light

Use this function to adjust the light intensity of iEQ45 Pro illuminated polar scope. If you have an illuminated-reticule eyepiece and has the same socket, you may use this option to adjust its light intensity.

5.4.10. HBX Heating OFF/ON

Turn on/off the controller LCD back heater. When “**Heating Controller**” is set to **ON**, the heater will automatically be turned on when the ambient temperature reaches 0°C (32°F) and shut off at 10°C.

5.4.11. Language

Select one of supported language.

5.4.12. Enter Alt-Azi Mode (or Enter EQ Mode)

Switch the iEQ45 Pro operation between EQ and AA modes.

5.5. Electric Focuser

This function controls an iOptron electric focuser.

5.6. PEC Option

You can turn “**PEC Playback On**” to improve tracking accuracy which is especially useful for long exposure astrophotography. The default status is “**PEC Playback Off**” when the mount is turned on.

5.6.1. Record PEC

All equatorial mounts have a small variation in the worm gears which may be corrected by using Period Error Correction or PEC. PEC is a system which improves the tracking accuracy of the mount by compensating for variations in the worm gear and is especially useful when doing astrophotography without autoguiding. Because the variations are regular, it is possible to record the corrections required to cancel out the worm gear variations and to play them back to correct the periodic error caused by the variations.

In order to use the PEC function, the Go2Nova[®] hand controller first needs to record the periodic error. The periodic error of the worm gear drive will be used to correct periodic error.

We recommend using a guiding camera to record the PE with autoguiding. Here’s how to use the PEC function:

1. Setup the mount with a telescope in autoguiding configuration by connecting a guiding camera via the mount’s Guide Port or using the ASCOM protocol;

2. Select “**MENU=>Settings => Set Guiding Rates**”. Set a guiding speed from 0.10X to 0.90X. The default setting is 0.25X;

3. Then press the **BACK** button and select “**PEC Option**” from the menu. Use the **▲** and **▼** scroll buttons to display the “**Record PEC**” option and press **ENTER** to start recording the periodic error.

4. It takes the worm gear 337.5 seconds to make one complete revolution. After 337.5 seconds PEC will automatically stop recording. The PEC value will be permanently stored inside PEC chip on R.A. motor drive until a new data are recorded.

5. If you want to re-record the periodic error, select “**Record PEC**” and repeat the recording processes again. The previously recorded information will be replaced with the current information.

5.6.2. PEC Data Integrity

This function will check the recorded PEC data integrity.

5.7. Park Telescope

This function parks the scope to one of four preset park positions.

5.8. Edit User Objects

Besides various star lists available in the hand controller, you can add, edit or delete your own user-defined objects. This is especially useful for newly found comets. You can also add your favorite observation object into the user object list for easy sky surfing. Up to 60 comets and other user objects can be stored.

5.8.1. Enter a New Comet

Press “MENU =>Edit User Objects” to set user objects.

```
User Defined Comet
Other Objects
```

Select “User Defined Comet” to add/browse/delete the user-defined comet list. Find the orbit parameters of a comet in the SkyMap format. For example, the C/2012 ISON has an orbit parameter:

No.	Name	Year	M	Day	q	e	ω	Ω	I	H	G
C/2012	S1 ISON	2013	11	28.7960	0.0125050	1.0000030	345.5088	295.7379	61.8570	6.0	4.0

Select “Add a New Comet” to add a new one:

```
Add a New Comet
Browse Comets
Delete a Comet
Delete All Comets
```

The hand controller will display the parameter entry screen:

```
Enter Comet Parameter
Date: 0000-00-00.0000
q: 0.000000
e: 0.000000
 $\omega$ : 000.0000
 $\Omega$ : 000.0000
i: 000.0000
```

Enter the parameters using the arrow buttons and number keys. Press **ENTER** and a confirmation screen will be displayed. Press **ENTER** again to store the object under the assigned user object number, or press **BACK** button to cancel.

5.8.2. Enter Other Objects or Observation List

Press “MENU =>Edit User Objects” to set user objects.

```
User Defined Comet
Other Objects
```

Select “Other Objects” to enter you own object:

```
Add a New Object
Browse Objects
Delete One Object
Delete All Objects
```

Select “**Add a New Object**”. A screen will be displayed asking you to **Enter R.A. and DEC coordinates**:

```
Enter R.A. and DEC
R.A.: 00h00m00s
DEC: +00d00m00s
```

You may enter the R.A. and DEC coordinates of the object you want to store, and press **ENTER** to confirm.

A more useful application of this function is to store your favorite viewing objects before heading to the field. When the “**Enter R.A. and DEC**” screen appears, press the **MENU** button. It brings up the catalogs that you can select the object from. Follow the screen instructions to add your favorite objects. Press **BACK** button to go back one level.

Press the **BACK** button to go back to the object entry submenu. You may review the records or delete those that are no longer wanted. Press the **BACK** button to finish the operation. Now you can slew to your favorite stars from “**Custom Objects**” catalog using “**Select and Slew.**”

5.9. Firmware Information

This option will display the mount type, firmware version information for the hand controller (HC), Main board (Main), R.A. board (RA), and DEC board (DEC).

5.10. Zero Position

5.10.1. Goto Zero Position

This moves your telescope to its Zero Position. When the power is turned on, the mount assumes the Zero Position. This is the reference point for alignment and GoTo functions.

5.10.2. Set Zero Position

This set the Zero Position for the firmware.

The Zero Position reference will be an undefined value after firmware upgrade, or it may lost during power outage or HC battery replacement. You can use this function to set the zero position referece.

Press the **ENTER** after moving the mount to Zero Position either manually or with the hand controller.

6. Maintenance and Servicing

6.1. Maintenance

The iEQ45 Pro mount is designed to be maintenance free. Do not overload the mount. Do not drop the mount as this will damage the mount and / or permanently degrade GOTO performance and tracking accuracy. Use a wet cloth to clean the mount and hand controller. Do not use solvent.

If your mount is not to be used for an extended period, dismount the OTAs and counterweight(s).

6.2. iOptron Customer Service

If you have any question concerning your iEQ45 contact iOptron Customer Service Department. Customer Service hours are 9:00 AM to 5:00 PM, Eastern Time, Monday through Friday. In the unlikely event that the iEQ45 requires factory servicing or repairing, write or call iOptron Customer Service Department first to receive an RMA# before returning the mount to the factory. Please provide details as to the nature of the problem as well as your name, address, e-mail address, purchase information and daytime telephone number. We have found that most problems can be resolved by e-mails or telephone calls. So please contact iOptron first to avoid returning the mount for repair.

It is strongly suggested that to send technical questions to support@ioptron.com. Call in the U.S. 1.781.569.0200.

6.3. Product End of Life Disposal Instructions



This electronic product is subject to disposal and recycling regulations that vary by country and region. It is your responsibility to recycle your electronic equipment per your local environmental laws and regulations to ensure that it will be recycled in a manner that protects human health and the environment. To find out where you can drop off your waste equipment for recycling, please contact your local waste recycle/disposal service or the product representative.

6.4. Battery Replacement and Disposal Instructions



Battery Disposal: Batteries contain chemicals that, if released, may affect the environment and human health. Batteries should be collected separately for recycling, and recycled at a local hazardous material disposal location adhering to your country and local government regulations. To find out where you can drop off your waste battery for recycling, please contact your local waste disposal service or the product representative.

Appendix A. Technical Specifications

Mount	German Equatorial Mount
Payload	45 lb (20kg)
Mount weight	20 lb (11.4kg)
Payload/Mount weight	1.75
Right Ascension worm wheel	Φ130mm, 256 teeth aluminum
Declination worm wheel	Φ116mm, 228 teeth aluminum
Right Ascension axis shaft	Φ50mm steel
Declination axis shaft	Φ40mm steel
Right Ascension bearing	Φ80mm ball bearing
Declination bearing	Φ68mm ball bearing
R.A. and DEC worm	Φ17mm brass
Motor drive	128X microstep stepper motor
Resolution	0.09 arc seconds
Transmission	Synchronous belt/Gear
Latitude adjustment range	5° ~ 70°
Azimuth adjustment range	± 6°
GPS	Built-in 32-channel GPS
Polar Scope	AccuAlign™ G2 with dark field illumination
Level indicator	Precision bubble
Hand Controller	Go2Nova® 8407+ with 358,000 objects database
PEC	Permanent PEC
Tracking	Automatic
Speed	1×,2×,8×,16×,64×,128×,256×,512×,MAX(1400X)
Counterweight bar	Φ28mm stainless steel
Counterweight	11 lb (5kg) X 2 (included)
Tripod	2" Stainless Steel (16.5lb or 7.5kg)
Dovetail	6" VIXEN/LOSMANDY-D dual saddle
Power consumption	0.45A(Tracking), 0.75A(GOTO)
Power requirement	12V DC(10 ~ 14V), 2Amp
AC adapter	100V ~ 240V (included)
Serial port	Yes (RJ9 on both mount and hand controller)
Autoguide port	Yes
Firmware upgrade	Yes
PC computer control	Yes (ASCOM)
Operation temperature	-20°C ~ 40°C

Appendix B. iEQ45 Pro Go2Nova[®] 8407+ HC MENU STRUCTURE

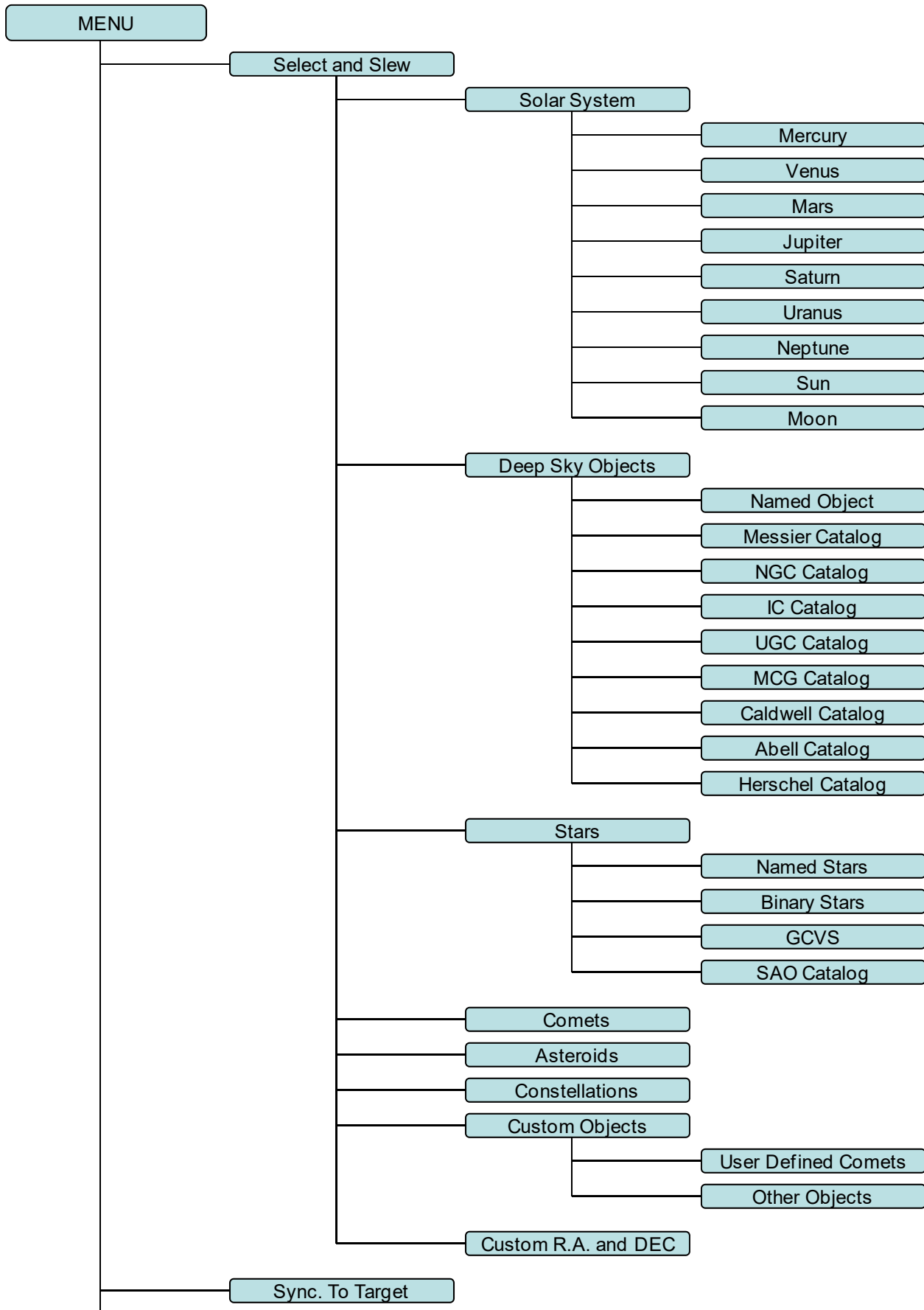

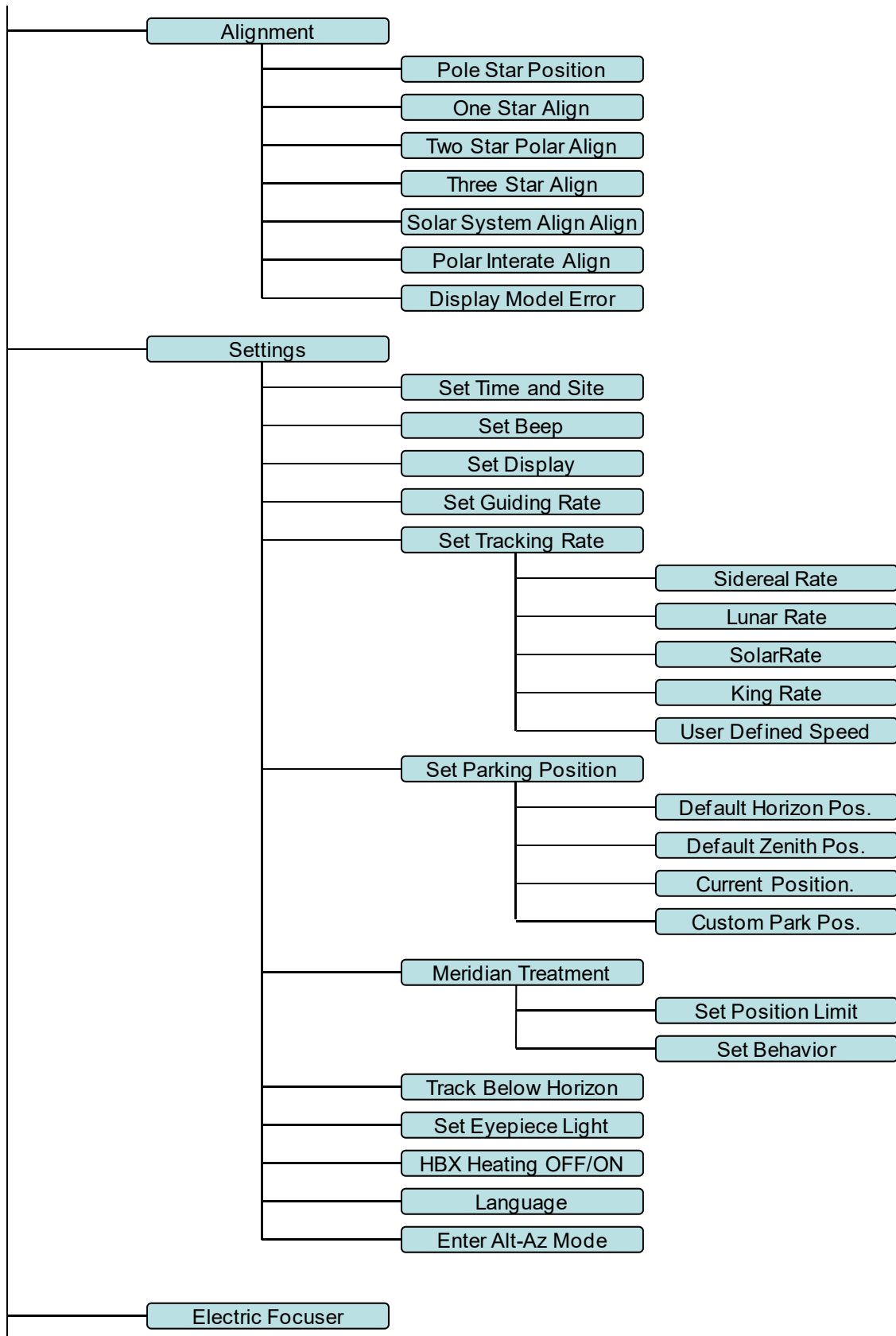

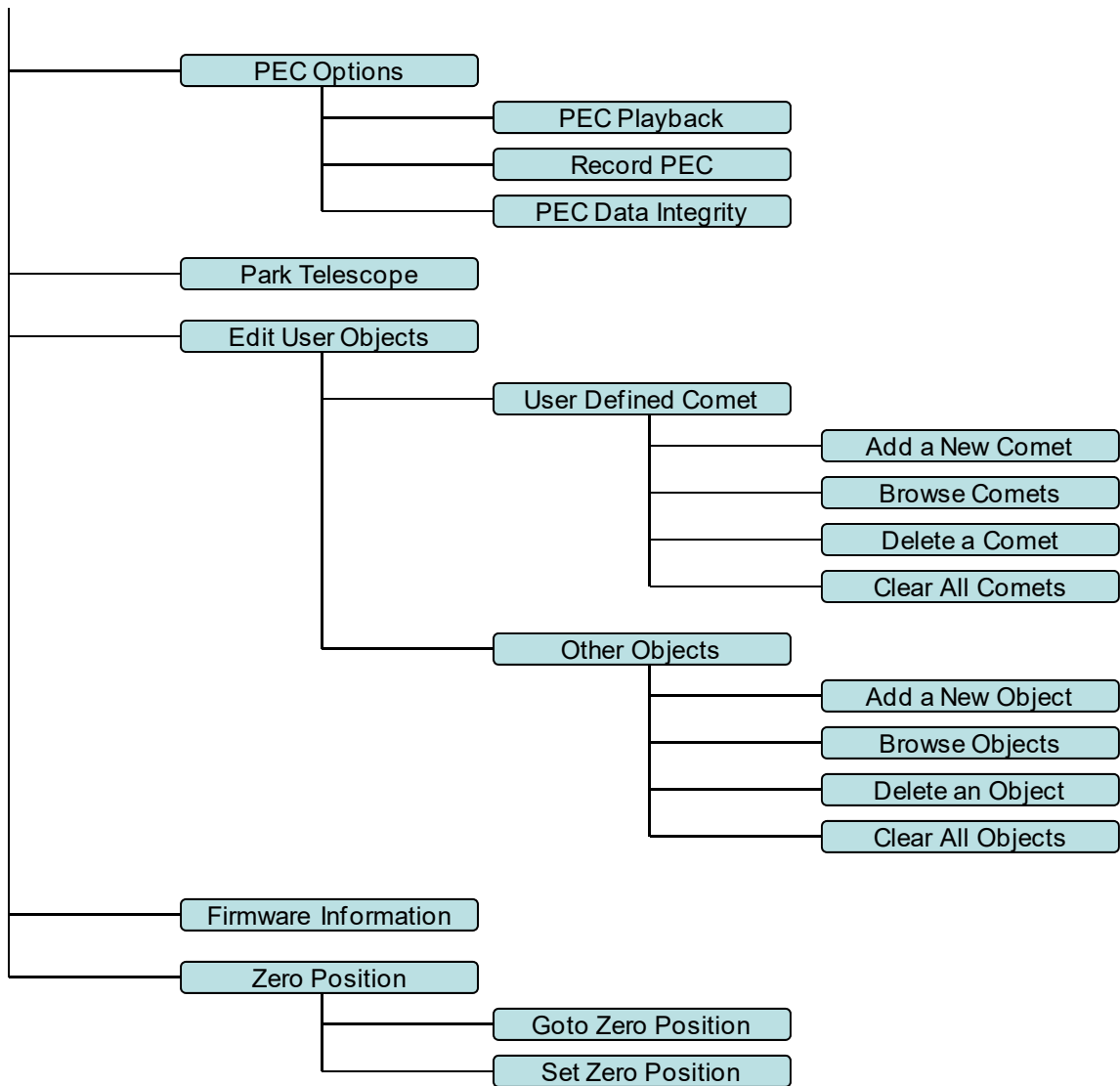

Appendix C. Firmware Upgrade

The firmware in the 8407+ Hand Controller and control boards can be upgraded by the customer. Please check iOptron's website, www.iOptron.com, under Support/iEQ Mount, select iEQ Pro for details.

Appendix D. Computer Control an iEQ45 Pro Mount

The iEQ45 Pro mount can be controlled by a SmartPhone, a Pad or a computer. It is supported by two types of computer connections:

- Connect to a computer via RS232 serial port. An optional RS232 to USB adapter (iOptron part #8435) is needed if your computer does not have a serial port, like most of the laptops on the market today. Follow the adapter instructions to install the adapter driver. The mount can be controlled via ASCOM protocol (Windows OS), or directly by some software, such as Sky Safari (Mac OS)
- Connect wirelessly with iOptron StarFi adapter (#8434) or some other third party adapter (may with limited function). The mount can be controlled via ASCOM protocol (Windows OS), SmartPhone/Pad and Mac OS wirelessly. See StarFi Instruction Manual for detailed information.

To control the mount via ASCOM protocol, you need:

1. Download and install the latest ASCOM Platform, currently 6.1 SP1, from <http://www.ascom-standards.org/>. Make sure your PC meets the software requirement. For 6.1 SP1, Windows XP users should install .NET Framework 4 (not the Client Profile). Windows Vista and Windows 7 users should install .NET Framework 4.5.2. Windows 8 and 8.1 users do not need install any additional components.
2. Download and install the latest iOptron Telescope ASCOM drive for iEQ45 Pro from iOptron website.
3. Planetarium software that supports ASCOM protocol. Follow software instructions to select the iOptron Telescope.

Please refer to iOptron website, www.iOptron.com, under Support Directory/ASCOM Driver, iOptron Telescope ASCOM Driver, for more detail.

Appendix E. Go2Nova[®] Star List

Messier Catalog

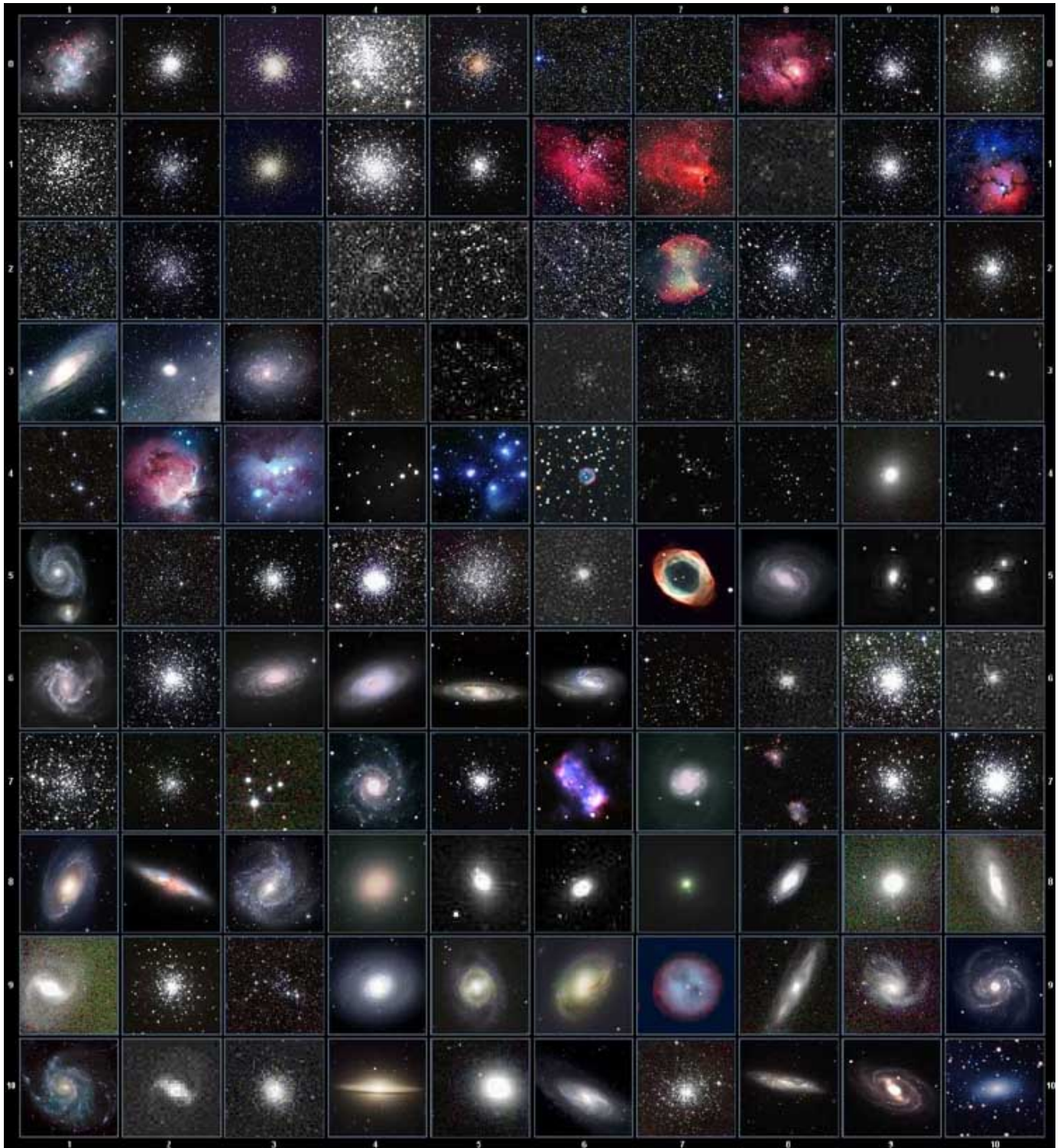

This table is licensed under the [GNU Free Documentation License](#). It uses material from the [Wikipedia article List of Messier objects](#)

Named Star List

001 Acamar	050 Asellus Australis	099 Kaus Media	148 Rastaba
002 Achernar	051 Asellus Borealis	100 Keid	149 Regulus
003 Acrux	052 Aspidiske	101 Kitalpha	150 Rigel
004 Acubens	053 Atik	102 Kochab	151 Rigel Kentaurus
005 Adhafera	054 Atlas	103 Kornephoros	152 Ruchbah
006 Adhara	055 Atria	104 Kurhah	153 Rukbat
007 Al Na'ir	056 Avoir	105 Lesath	154 Sabik
008 Albali	057 Azha	106 Maia	155 Sadachbia
009 Alberio	058 Baten Kaitos	107 Marfik	156 Sadalbari
010 Alchibar	059 Beid	108 Markab	157 Sadalmelik
011 Alcor	060 Bellatrix	109 Matar	158 Sadalsuud
012 Alcyone	061 Betelgeuse	110 Mabsuta	159 Sadr
013 Aldebaran	062 Biham	111 Megrez	160 Saiph
014 Alderamin	063 Canopus	112 Meissa	161 Scheat
015 Alfirk	064 Capella	113 Mekbuda	162 Schedar
016 Algedi	065 Caph	114 Menkalinan	163 Seginus
017 Algenib	066 Castor	115 Menkar	164 Shaula
018 Algiebra	067 Celabrai	116 Menkent	165 Sheiak
019 Algol	068 Celaeno	117 Menkib	166 Sheratan
020 Algorab	069 Chara	118 Merak	167 Sirius
021 Alhena	070 Chertan	119 Merope	168 Skat
022 Alioth	071 Cor Caroli	120 Mesartim	169 Spica
023 Alkaid	072 Cursa	121 Miaplacidus	170 Sterope
024 Alkalurops	073 Dabih	122 Mintaka	171 Sulafat
025 Alkes	074 Deneb	123 Mira	172 Syrma
026 Almach	075 Deneb Algedi	124 Mirach	173 Talitha
027 Alnasl	076 Deneb Kaitos	125 Mirfak	174 Tania Australis
028 Alnilam	077 Denebola	126 Mirzam	175 Tania Borealis
029 Alnitak	078 Dubhe	127 Mizar	176 Tarazed
030 Alphard	079 Edasich	128 Muphrid	177 Taygeta
031 Alphecca	080 Electra	129 Muscida	178 Thuban
032 Alpheratz	081 Elnath	130 Nashira	179 Unukalhai
033 Alrakis	082 Eltanin	131 Nekkar	180 Vega
034 Alrescha	083 Enif	132 Nihal	181 Vindemiatrix
035 Alshain	084 Errai	133 Nunki	182 Wasat
036 Altair	085 Fomalhaut	134 Nusakan	183 Wazn
037 Altais	086 Furud	135 Peacock	184 Yed Posterior
038 Alterf	087 Gacrux	136 Phact	185 Yed Prior
039 Aludra	088 Giasar	137 Phecda	186 Zaniah
040 Alula Australis	089 Gienah	138 Pherkad	187 Zaurak
041 Alula Borealis	090 Gomeisa	139 Pleione	188 Zavijava
042 Alya	091 Graffias	140 Polaris	189 Zosma
043 Ancha	092 Groombridge 1830	141 Pollux	190 Zubenelgenubi
044 Ankaa	093 Grumium	142 Porrima	191 Zubeneschamali
045 Antares	094 Hamal	143 Procyon	192 Barnard's Star
046 Arcturus	095 Homan	144 Propus	193 Kapteyn's Star
047 Arkab	096 Izar	145 Rassalas	194 Kruger 60
048 Arneb	097 Kaus Australis	146 Rasagethi	195 Luyten's Star
049 Ascella	098 Kaus Borealis	147 Rasalhague	

Modern Constellations

No.	Constellation	Abbreviation
1	Andromeda	And
2	Antlia	Ant
3	Apus	Aps
4	Aquarius	Aqr
5	Aquila	Aql
6	Ara	Ara
7	Aries	Ari
8	Auriga	Aur
9	Boötes	Boo
10	Caelum	Cae
11	Camelopardalis	Cam
12	Cancer	Cnc
13	Canes Venatici	CVn
14	Canis Major	CMA
15	Canis Minor	CMi
16	Capricornus	Cap
17	Carina	Car
18	Cassiopeia	Cas
19	Centaurus	Cen
20	Cepheus	Cep
21	Cetus	Cet
22	Chamaeleon	Cha
23	Circinus	Cir
24	Columba	Col
25	Coma Berenices	Com
26	Corona Australis	CrA
27	Corona Borealis	CrB
28	Corvus	Crv
29	Crater	Crt
30	Crux	Cru
31	Cygnus	Cyg
32	Delphinus	Del
33	Dorado	Dor
34	Draco	Dra
35	Equuleus	Equ
36	Eridanus	Eri
37	Fornax	For
38	Gemini	Gem
39	Grus	Gru
40	Hercules	Her
41	Horologium	Hor
42	Hydra	Hya
43	Hydrus	Hyi
44	Indus	Ind

No.	Constellation	Abbreviation
45	Lacerta	Lac
46	Leo	Leo
47	Leo Minor	LMi
48	Lepus	Lep
49	Libra	Lib
50	Lupus	Lup
51	Lynx	Lyn
52	Lyra	Lyr
53	Mensa	Men
54	Microscopium	Mic
55	Monoceros	Mon
56	Musca	Mus
57	Norma	Nor
58	Octans	Oct
59	Ophiuchus	Oph
60	Orion	Ori
61	Pavo	Pav
62	Pegasus	Peg
63	Perseus	Per
64	Phoenix	Phe
65	Pictor	Pic
66	Pisces	Psc
67	Piscis Austrinus	PsA
68	Puppis	Pup
69	Pyxis	Pyx
70	Reticulum	Ret
71	Sagitta	Sge
72	Sagittarius	Sgr
73	Scorpius	Sco
74	Sculptor	Scl
75	Scutum	Sct
76	Serpens	Ser
77	Sextans	Sex
78	Taurus	Tau
79	Telescopium	Tel
80	Triangulum	Tri
81	Triangulum Australe	TrA
82	Tucana	Tuc
83	Ursa Major	UMa
84	Ursa Minor	UMi
85	Vela	Vel
86	Virgo	Vir
87	Volans	Vol
88	Vulpecula	Vul

Deep Sky Object List

ID No.	OBJECT	NGC #	Messier#	IC#	A(Abell)	U(UGC)	ID No.	OBJECT	NGC #	Messier#	IC#	A(Abell)	U(UGC)
1	Andromeda Galaxy	224	31				31	Hind's Variable Nebula	1555				
2	Barnards Galaxy	6822					32	Hubble's Variable Nebula	2261				
3	Beehive Cluster	2632	44				33	Integral Sign Galaxy					3697
4	Blackeye Galaxy	4926	64				34	Jewel Box Cluster	4755				
5	Blinking Planetary Nebula	6826					35	Keyhole Nebula	3372				
6	Blue Flash Nebula	6905					36	Lagoon Nebula	6523	8			
7	Blue Planetary	3918					37	Little Gem	6445				
8	Blue Snowball Nebula	7662					38	Little Gem Nebula	6818				
9	Box Nebula	6309					39	Little Ghost Nebula	6369				
10	Bubble Nebula	7635					40	North American Nebula	7000				
11	Bipolar Nebula	6302					41	Omega Nebula	6618	17			
12	Butterfly Cluster	6405	6				42	Orion Nebula	1976	42			
13	California Nebula	1499					43	Owl Nebula	3587	97			
14	Cat's Eye Nebula	6543					44	Pelican Nebula			5070		
15	Cocoon Nebula			5146			45	Phantom Streak Nebula	6741				
16	Cone Nebula	2264					46	Pinwheel Galaxy	598	33			
17	Cork Nebula	650-51	76				47	Pleiades		45			
18	Crab Nebula	1952	1				48	Ring Nebula	6720	57			
19	Crescent Nebula	6888					49	Ring Tail Galaxy	4038				
20	Draco Dwarf					10822	50	Rosette Nebula	2237				
21	Duck Nebula	2359					51	Saturn Nebula	7009				
22	Dumbbell Nebula	6853	27				52	Sextans B Dwarf					5373
23	Eagle Nebula		16				53	Small Magellanic Cloud	292				
24	Eight-Burst Nebula	3132					54	Sombrero Galaxy	4594	104			
25	Eskimo Nebula	2392					55	Spindle Galaxy	3115				
26	Flaming Star Nebula			405			56	Tank Track Nebula	2024				
27	Ghost of Jupiter	3242					57	Trifid Nebula	6514	20			
28	Great Cluster	6205	13				58	Ursa Minor Dwarf					9749
29	Helix Nebula	7293					59	Whirlpool Galaxy	5194	51			
30	Hercules Galaxy Cluster				2151		60	Wild Duck Cluster	6705	11			

Double Star List

No.	Object	Const	Sep.	Magitude	SAO	Comm. Name
1	Gam	And	9.8	2.3 / 5.1	37734	Almaak
2	Pi	And	35.9	4.4 / 8.6	54033	
3	Bet	Aql	12.8	3.7 / 11	125235	Alshain
4	11	Aql	17.5	5.2 / 8.7	104308	
5	15	Aql	34	5.5 / 7.2	142996	
6	E2489	Aql	8.2	5.6 / 8.6	104668	
7	57	Aql	36	5.8 / 6.5	143898	
8	Zet	Aqr	2.1	4.3 / 4.5	146108	
9	94	Aqr	12.7	5.3 / 7.3	165625	
10	41	Aqr	5.1	5.6 / 7.1	190986	
11	107	Aqr	6.6	5.7 / 6.7	165867	
12	12	Aqr	2.5	5.8 / 7.3	145065	
13	Tau	Aqr	23.7	5.8 / 9.0	165321	
14	Gam	Ari	7.8	4.8 / 4.8	92681	Mesartim
15	Lam	Ari	37.8	4.8 / 6.7	75051	
16	The	Aur	3.6	2.6 / 7.1	58636	
17	Nu	Aur	55	4.0 / 9.5	58502	
18	Ome	Aur	5.4	5.0 / 8.0	57548	
19	Eps	Boo	2.8	2.5 / 4.9	83500	Izar
20	Del	Boo	105	3.5 / 7.5	64589	
21	Mu 1	Boo	108	4.3 / 6.5	64686	Alkalurops
22	Tau	Boo	4.8	4.5 / 11	100706	
23	Kap	Boo	13.4	4.6 / 6.6	29046	
24	Xi	Boo	6.6	4.7 / 6.9	101250	
25	Pi	Boo	5.6	4.9 / 5.8	101139	
26	lot	Boo	38	4.9/7.5/13	29071	
27	E1835	Boo	6.2	5.1 / 6.9	120426	
28	44	Boo	2.2	5.3 / 6.2	45357	
29		Cam	2.4	4.2 / 8.5	24054	
30	32	Cam	21.6	5.3 / 5.8	2102	
31	Alp 2	Cap	6.6	3.6 / 10	163427	Secunda giedi
32	Alp 1	Cap	45	4.2 / 9.2	163422	Prima giedi
33	Pi	Cap	3.4	5.2 / 8.8	163592	
34	Omi	Cap	21	5.9 / 6.7	163625	
35	Alp	Cas	64.4	2.2 / 8.9	21609	Shedir

No.	Object	Const	Sep.	Magitude	SAO	Comm. Name
36	Eta	Cas	12.9	3.5 / 7.5	21732	Achird
37	lot	Cas	2.3	4.7/7.0/8.2	12298	
38	Psi	Cas	25	4.7 / 8.9	11751	
39	Sig	Cas	3.1	5.0 / 7.1	35947	
40	E3053	Cas	15.2	5.9 / 7.3	10937	
41	3	Cen	7.9	4.5 / 6.0	204916	
42	Bet	Cep	13.6	3.2 / 7.9	10057	Alfirk
43	Del	Cep	41	3.5 / 7.5	34508	
44	Xi	Cep	7.6	4.3 / 6.2	19827	Al kurhah
45	Kap	Cep	7.4	4.4 / 8.4	9665	
46	Omi	Cep	2.8	4.9 / 7.1	20554	
47	E2840	Cep	18.3	5.5 / 7.3	33819	
48	E2883	Cep	14.6	5.6 / 7.6	19922	
49	Gam	Cet	2.8	5.0 / 7.7	110707	Kaffaljdhma
50	37	Cet	50	5.2 / 8.7	129193	
51	66	Cet	16.5	5.7 / 7.5	129752	
52	Eps	CMa	7.5	1.5 / 7.4	172676	Adhara
53	Tau	CMa	8.2	4.4/10/11	173446	
54	145	CMa	25.8	4.8 / 6.8	173349	
55	Mu	CMa	2.8	5.0 / 7.0	152123	
56	Nu 1	CMa	17.5	5.8 / 8.5	151694	
57	lot	Cnc	30.5	4.2 / 6.6	80416	
58	Alp	Cnc	11	4.3 / 12	98267	Acubens
59	Zet	Cnc	6	5.1 / 6.2	97646	
60	24	Com	20.6	5.0 / 6.6	100160	
61	35	Com	1.2	5.1/7.2/9.1	82550	
62	2	Com	3.7	5.9 / 7.4	82123	
63	Zet	CrB	6.1	5.0 / 6.0	64833	
64	Gam	Crt	5.2	4.1 / 9.6	156661	
65	Del	Crv	24.2	3.0 / 9.2	157323	Algorab
66	Alp	CVn	19.4	2.9 / 5.5	63257	Cor caroli
67	25	CVn	1.8	5.0 / 6.9	63648	
68	2	CVn	11.4	5.8 / 8.1	44097	
69	Gam	Cyg	41	2.2 / 9.5	49528	Sadr
70	Del	Cyg	2.5	2.9 / 6.3	48796	

No.	Object	Const	Sep.	Magitude	SAO	Comm. Name
71	Bet	Cyg	34.4	3.1 / 5.1	87301	Albireo
72	Omi 1	Cyg	107	3.8 / 6.7	49337	
73	52	Cyg	6.1	4.2 / 9.4	70467	
74	Ups	Cyg	15.1	4.4 / 10	71173	
75	Mu	Cyg	1.9	4.7 / 6.1	89940	
76	Psi	Cyg	3.2	4.9 / 7.4	32114	
77	17	Cyg	26	5.0 / 9.2	68827	
78	61	Cyg	30.3	5.2 / 6.0	70919	
79	49	Cyg	2.7	5.7 / 7.8	70362	
80	E2762	Cyg	3.4	5.8 / 7.8	70968	
81	E2741	Cyg	1.9	5.9 / 7.2	33034	
82	Gam	Del	9.6	4.5 / 5.5	106476	
83	Eta	Dra	5.3	2.7 / 8.7	17074	
84	Eps	Dra	3.1	3.8 / 7.4	9540	Tyl
85	47	Dra	34	4.8 / 7.8	31219	
86	Nu	Dra	61.9	4.9 / 4.9	30450	
87	Psi	Dra	30.3	4.9 / 6.1	8890	
88	26	Dra	1.7	5.3 / 8.0	17546	
89	16&17	Dra	90	5.4/5.5/6.4	30012	
90	Mu	Dra	1.9	5.7 / 5.7	30239	
91	40/41	Dra	19.3	5.7 / 6.1	8994	
92	1	Equ	10.7	5.2 / 7.3	126428	
93	The	Eri	4.5	3.4 / 4.5	216114	Acamar
94	Tau 4	Eri	5.7	3.7 / 10	168460	
95	Omi 2	Eri	8.3	4.4/9.5/11	131063	Keid
96	32	Eri	6.8	4.8 / 6.1	130806	
97	39	Eri	6.4	5.0 / 8.0	149478	
98	Alp	For	5.1	4.0 / 6.6	168373	Fornacis
99	Ome	For	10.8	5.0 / 7.7	167882	
100	Alp	Gem	3.9	1.9 / 2.9	60198	Castor
101	Del	Gem	5.8	3.5 / 8.2	79294	Wasat
102	Lam	Gem	9.6	3.6 / 11	96746	
103	Kap	Gem	7.1	3.6 / 8.1	79653	
104	Zet	Gem	87	3.8/10/8.0	79031	Mekbuda
105	38	Gem	7.1	4.7 / 7.7	96265	

No.	Object	Const	Sep.	Magitude	SAO	Comm. Name
106	Del	Her	8.9	3.1 / 8.2	84951	Sarin
107	Mu	Her	34	3.4 / 9.8	85397	
108	Alp	Her	4.6	3.5 / 5.4	102680	Rasalgethi
109	Gam	Her	42	3.8 / 9.8	102107	
110	Rho	Her	4.1	4.6 / 5.6	66001	
111	95	Her	6.3	5.0 / 5.2	85647	
112	Kap	Her	27	5.0 / 6.2	101951	
113	E2063	Her	16.4	5.7 / 8.2	46147	
114	100	Her	14.3	5.9 / 5.9	85753	
115	54	Hya	8.6	5.1 / 7.1	182855	
116	HN69	Hya	10.1	5.9 / 6.8	181790	
117	Eps	Hyd	2.7	3.4 / 6.8	117112	
118	The	Hyd	29.4	3.9 / 10	117527	
119	N	Hyd	9.4	5.6 / 5.8	179968	
120		Lac	28.4	4.5 / 10	72155	
121	8	Lac	22	5.7/6.5/10	72509	
122	Gam 1	Leo	4.4	2.2 / 3.5	81298	Algieba
123	lot	Leo	1.7	4.0 / 6.7	99587	
124	54	Leo	6.6	4.3 / 6.3	81583	
125	Gam	Lep	96	3.7 / 6.3	170757	
126	lot	Lep	12.8	4.4 / 10	150223	
127	Kap	Lep	2.6	4.5 / 7.4	150239	
128	h3752	Lep	3.2	5.4 / 6.6	170352	
129	lot	Lib	57.8	4.5 / 9.4	159090	
130		Lib	23	5.7 / 8.0	183040	
131	Mu	Lib	1.8	5.8 / 6.7	158821	
132	Eta	Lup	15	3.6 / 7.8	207208	
133	Xi	Lup	10.4	5.3 / 5.8	207144	
134	38	Lyn	2.7	3.9 / 6.6	61391	
135	12	Lyn	1.7	5.4/6.0/7.3	25939	
136	19	Lyn	14.8	5.8 / 6.9	26312	
137	Bet	Lyr	46	3.4 / 8.6	67451	Sheliak
138	Zet	Lyr	44	4.3 / 5.9	67321	
139	Eta	Lyr	28.1	4.4 / 9.1	68010	Aldafar
140	Eps 1	Lyr	2.6	5.0 / 6.1	67309	Double dbl1

No.	Object	Const	Sep.	Magitude	SAO	Comm. Name
141	Eps 2	Lyr	2.3	5.2 / 5.5	67315	Double dbl2
142	Alp	Mic	20.5	5.0 / 10	212472	
143	Zet	Mon	32	4.3 / 10	135551	
144	Eps	Mon	13.4	4.5 / 6.5	113810	
145	Bet	Mon	7.3	4.7/4.8/6.1	133316	
146	15	Mon	2.8	4.7 / 7.5	114258	
147	70	Oph	4.5	4.0 / 5.9	123107	
148	67	Oph	55	4.0 / 8.6	123013	
149	Lam	Oph	1.5	4.2 / 5.2	121658	Marfic
150	Xi	Oph	3.7	4.4 / 9.0	185296	
151	36	Oph	4.9	5.1 / 5.1	185198	
152	Tau	Oph	1.7	5.2 / 5.9	142050	
153	Rho	Oph	3.1	5.3 / 6.0	184382	
154	39	Oph	10.3	5.4 / 6.9	185238	
155	Bet	Ori	9.5	0.1 / 6.8	131907	Rigel
156	Del	Ori	53	2.2 / 6.3	132220	Mintaka
157	lot	Ori	11.3	2.8 / 6.9	132323	Nair al saif
158	Lam	Ori	4.4	3.6 / 5.5	112921	Meissa
159	Sig	Ori	13	3.8/7.2/6.5	132406	
160	Rho	Ori	7.1	4.5 / 8.3	112528	
161	E747	Ori	36	4.8 / 5.7	132298	
162	1	Peg	36.3	4.1 / 8.2	107073	
163	Eps	Per	8.8	2.9 / 8.1	56840	
164	Zet	Per	12.9	2.9 / 9.5	56799	Atik
165	Eta	Per	28.3	3.3 / 8.5	23655	Miram in bevar
166	The	Per	18.3	4.1 / 10	38288	
167	E331	Per	12.1	5.3 / 6.7	23765	
168	Del	PsA	5.1	4.2 / 9.2	214189	
169	lot	PsA	20	4.3 / 11	213258	
170	Bet	PsA	30.3	4.4 / 7.9	213883	
171	Gam	PsA	4.2	4.5 / 8.0	214153	
172	Eta	PsA	1.7	5.8 / 6.8	190822	
173	Alp	Psc	1.8	4.2 / 5.2	110291	Alrisha
174	55	Psc	6.5	5.4 / 8.7	74182	
175	Psi	Psc	30	5.6 / 5.8	74483	

No.	Object	Const	Sep.	Magitude	SAO	Comm. Name
176	Zet	Psc	23	5.6 / 6.5	109739	
177	Kap	Pup	9.9	4.5 / 4.7	174199	
178	Eta	Pup	9.6	5.8 / 5.9	174019	
179	Eps	Scl	4.7	5.4 / 8.6	167275	
180	Bet	Sco	13.6	2.6 / 4.9	159682	Graffias
181	Sig	Sco	20	2.9 / 8.5	184336	Alniyat
182	Nu	Sco	41	4.2 / 6.1	159764	Jabbah
183	2	Sco	2.5	4.7 / 7.4	183896	
184		Sco	23	5.4 / 6.9	207558	
185	Hn39	Sco	5.4	5.9 / 6.9	184369	
186	12	Sco	3.9	5.9 / 7.9	184217	
187	Bet	Ser	31	3.7 / 9.0	101725	
188	Del	Ser	4.4	4.2 / 5.2	101624	
189	Nu	Ser	46	4.3 / 8.5	160479	
190	The	Ser	22.3	4.5 / 5.4	124070	Alya
191	59	Ser	3.8	5.3 / 7.6	123497	
192	Zet	Sge	8.5	5.0 / 8.8	105298	
193	Eta	Sgr	3.6	3.2 / 7.8	209957	
194		Sgr	5.5	5.2 / 6.9	209553	
195	Phi	Tau	52	5.0 / 8.4	76558	
196	Chi	Tau	19.4	5.7 / 7.6	76573	
197	118	Tau	4.8	5.8 / 6.6	77201	
198	6	Tri	3.9	5.3 / 6.9	55347	
199	Zet	UMa	14	2.4 / 4.0	28737	Mizar
200	Nu	UMa	7.2	3.5 / 9.9	62486	Alula borealis
201	23	UMa	23	3.6 / 8.9	14908	
202	Ups	UMa	11.6	3.8 / 11	27401	
203	Xi	UMa	1.8	4.3 / 4.8	62484	Alula australia
204	Sig 2	UMa	3.9	4.8 / 8.2	14788	
205	57	UMa	5.4	5.4 / 5.4	62572	
206	Alp	UMi	18.4	2.0 / 9.0	308	Polaris
207	Gam	Vir	1.4	3.5 / 3.5	138917	Porrima
208	The	Vir	7.1	4.4 / 9.4	139189	
209	Phi	Vir	4.8	4.8 / 9.3	139951	
210	84	Vir	2.9	5.7 / 7.9	120082	

IOPTRON TWO YEAR TELESCOPE, MOUNT, AND CONTROLLER WARRANTY

A. iOptron warrants your telescope, mount, or controller to be free from defects in materials and workmanship for two years. iOptron will repair or replace such product or part which, upon inspection by iOptron, is found to be defective in materials or workmanship. As a condition to the obligation of iOptron to repair or replace such product, the product must be returned to iOptron together with proof-of-purchase satisfactory to iOptron.

B. The Proper Return Merchant Authorization Number must be obtained from iOptron in advance of return. Call iOptron at 1.781.569.0200 to receive the RMA number to be displayed on the outside of your shipping container. All returns must be accompanied by a written statement stating the name, address, and daytime telephone number of the owner, together with a brief description of any claimed defects. Parts or product for which replacement is made shall become the property of iOptron.

The customer shall be responsible for all costs of transportation and insurance, both to and from the factory of iOptron, and shall be required to prepay such costs.

iOptron shall use reasonable efforts to repair or replace any telescope, mount, or controller covered by this warranty within thirty days of receipt. In the event repair or replacement shall require more than thirty days, iOptron shall notify the customer accordingly. iOptron reserves the right to replace any product which has been discontinued from its product line with a new product of comparable value and function.

This warranty shall be void and of no force of effect in the event a covered product has been modified in design or function, or subjected to abuse, misuse, mishandling or unauthorized repair. Further, product malfunction or deterioration due to normal wear is not covered by this warranty.

IOPTRON DISCLAIMS ANY WARRANTIES, EXPRESS OR IMPLIED, WHETHER OF MERCHANTABILITY OF FITNESS FOR A PARTICULAR USE, EXCEPT AS EXPRESSLY SET FORTH HERE. THE SOLE OBLIGATION OF IOPTRON UNDER THIS LIMITED WARRANTY SHALL BE TO REPAIR OR REPLACE THE COVERED PRODUCT, IN ACCORDANCE WITH THE TERMS SET FORTH HERE. IOPTRON EXPRESSLY DISCLAIMS ANY LOST PROFITS, GENERAL, SPECIAL, INDIRECT OR CONSEQUENTIAL DAMAGES WHICH MAY RESULT FROM BREACH OF ANY WARRANTY, OR ARISING OUT OF THE USE OR INABILITY TO USE ANY IOPTRON PRODUCT. ANY WARRANTIES WHICH ARE IMPLIED AND WHICH CANNOT BE DISCLAIMED SHALL BE LIMITED IN DURATION TO A TERM OF TWO YEARS FROM THE DATE OF ORIGINAL RETAIL PURCHASE.

Some states do not allow the exclusion or limitation of incidental or consequential damages or limitation on how long an implied warranty lasts, so the above limitations and exclusions may not apply to you.

This warranty gives you specific legal rights, and you may also have other rights which vary from state to state.

iOptron reserves the right to modify or discontinue, without prior notice to you, any model or style telescope.

If warranty problems arise, or if you need assistance in using your telescope, mount, or controller contact:

iOptron Corporation
Customer Service Department
6E Gill Street
Woburn, MA 01801
www.ioptron.com
support@ioptron.com
Tel. (781)569-0200
Fax. (781)935-2860
Monday-Friday 9AM-5PM EST

NOTE: This warranty is valid to U.S.A. and Canadian customers who have purchased this product from an authorized iOptron dealer in the U.S.A. or Canada or directly from iOptron. Warranty outside the U.S.A. and Canada is valid only to customers who purchased from an iOptron Distributor or Authorized iOptron Dealer in the specific country. Please contact them for any warranty.