

MODEL SSP-5

Generation 2

PHOTOELECTRIC PHOTOMETER

TECHNICAL MANUAL FOR

THEORY OF OPERATION AND OPERATING PROCEDURES

***** IMPORTANT *****

**PLEASE READ THIS MANUAL
THOROUGHLY BEFORE ATTEMPTING
TO OPERATE THE PHOTOMETER**

 ***OPTEC, Inc.***

OPTICAL AND ELECTRONIC PRODUCTS

**sales@optecinc.com
<http://www.optecinc.com>**

**199 Smith St.
Lowell, MI 49331
U.S.A.
(616) 897-9351
(616) 897-8229 FAX
(888) 488-0381 Toll-Free**

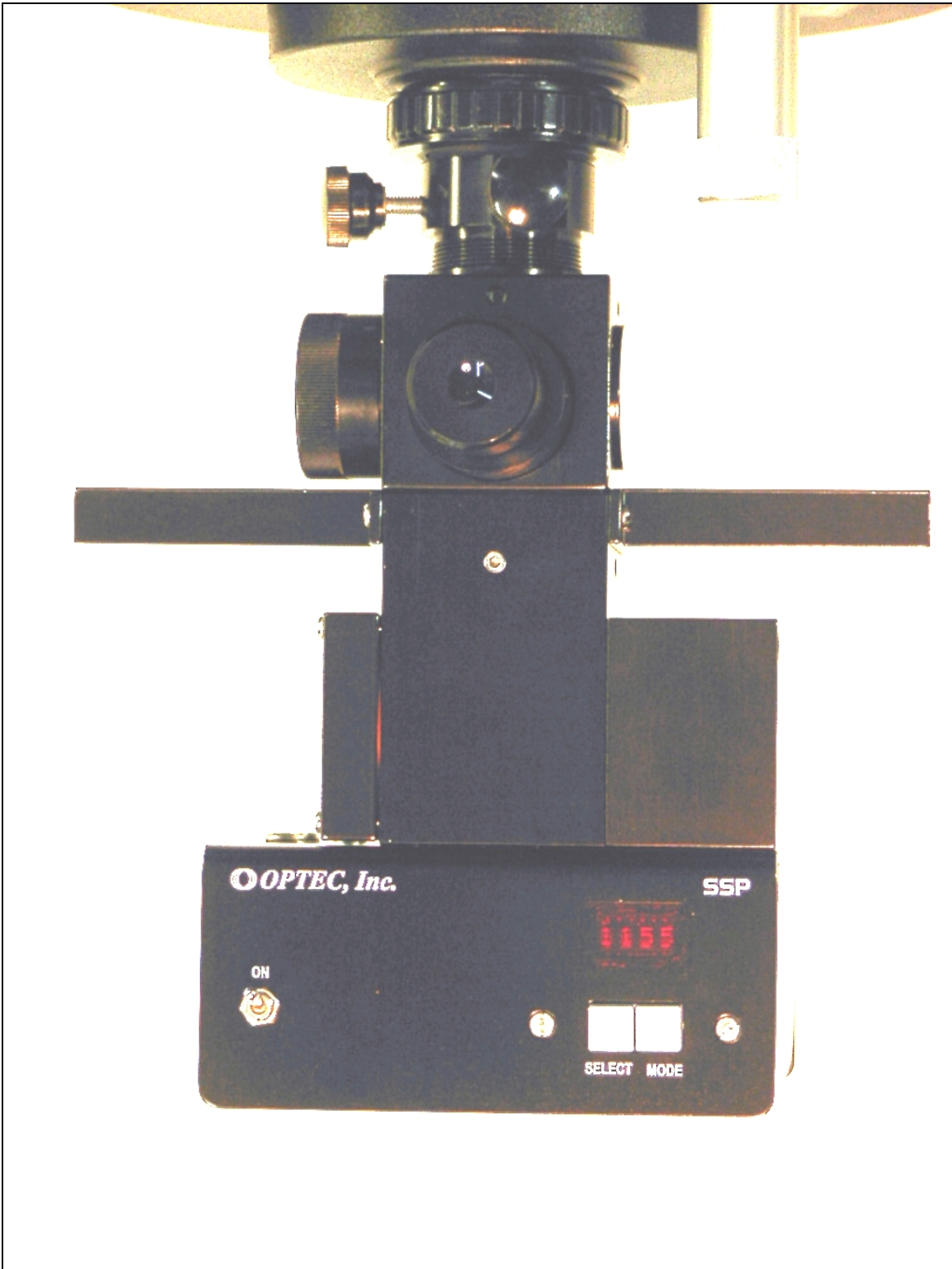

Model SSP-5A photoelectric photometer shown with 8-inch Telescope.

TABLE OF CONTENTS

June 2006

<i>Section</i>		<i>Page</i>
1.0	INTRODUCTION.	1
2.0	THEORY OF OPERATION.	3
	2.1 Photometer Head.	3
	2.2 Detector - PMT Options.	4
	2.3 Field Aperture.	5
	2.4 Fabry Lens.	5
	2.5 Filters.	5
	2.6 High Voltage Supply.	6
	2.7 Preamp & Low Pass Amplifier.	7
	2.8 Main Board.	8
	2.9 Performance.	9
3.0	OPERATING PROCEDURES.	10
	3.1 Check-Out List.	10
	3.2 Using the Photometer.	11
	3.3 Calibration and Adjustment.	12
	3.4 PC Interface Program	13
4.0	TROUBLE-SHOOTING GUIDE.	14
5.0	SPECIFICATIONS.	16
6.0	JOHNSON FILTERS.	18
7.0	STRÖMGREN FILTERS.	23
 <i>Appendices</i>		
A	Motorized Filter Bar Option	A-1
B	Determination of Field Aperture Size	B-1
C	SSP-3 Wiring Diagram	C-1
D	SSP-5 Circuit Diagram	D-1
E	Sample Data Entry Form	E-1
F	PMT Data Sheets	F-1
G	SSP Firmware Command Set	G-1

LIST OF FIGURES

<i>Figure</i>		<i>Page</i>
1-1	SSP-5a attached to a Schmidt Cass. Telescope (SCT).	Cover
1-2	The SSP-5 photometer system and accessories	2
2-1	Cross-sectional view of the SSP-5.	3
2-2	Power supply and signal processing function diagram.	7
2-3	Performance of the SSP-5 compared with the SSP-3.	9
3-1	Identification of controls and features of the SSP-5.	10

LIST OF TABLES

<i>Table</i>		<i>Page</i>
6-1	Physical characteristics of the Optec filters.	18
6-2	Standard UBVR I response functions according to Johnson.	19
6-3	R6350 normalized response with Optec UB V filters.	20
6-4	R6358 normalized response with Optec UBVR filters.	21
6-5	Transmission of the Optec SSP-5 UB V and SSP-3 UBVR filters.	22
7-1	Optical specifications of Strömngren filters.	23
7-2	Physical specifications of Strömngren filters.	24

SECTION 1.0

INTRODUCTION

Optec has developed a high-precision stellar photoelectric photometer that makes use of a miniature photomultiplier tube for sensitivity and faster time response. Using the same design philosophy encompassed in the popular SSP-3, the SSP-5 looks and operates in very much the same way. The use of a photomultiplier tube (PMT) allows fainter stars to be measured accurately and the enhanced response time, of 1 ms, allows fast events such as lunar occultation to be recorded with greater time resolution.

With the R6350 PMT option, the SSP-5 can exhibit an S-5 response similar to the original 1P21 photomultiplier tube. For researchers interested in greater low light sensitivity and extended red response to 830 nm, the R6358 PMT option is available along with Johnson UBV filters. Each PMT is a 9-stage, side-on, low-noise photomultiplier housed in a small ½-inch diameter enclosure.

In spite of the fact that a PMT based photometer is more sensitive to damage from bright lights or rough handling, a great deal of effort has been expended to make the SSP-5 nearly as survivable as the SSP-3. The SSP-5 will allow the researcher to measure both bright and faint stars in the UBV spectral region with the degree of precision and reliability associated with the venerable SSP-3.

The SSP-5 Photometer is the central part of a complete stellar magnitude measurement system as shown in Figure 1-2. This latest version of the SSP-5 features a serial output port for connection to a PC or laptop computer. An interface program called SSPDATAQ (freeware) is available with updated version found on the Optec web site. This program can control all aspects of the instrument and produce data files that are compatible with RPHOT. RPHOT is a complete data reduction program.

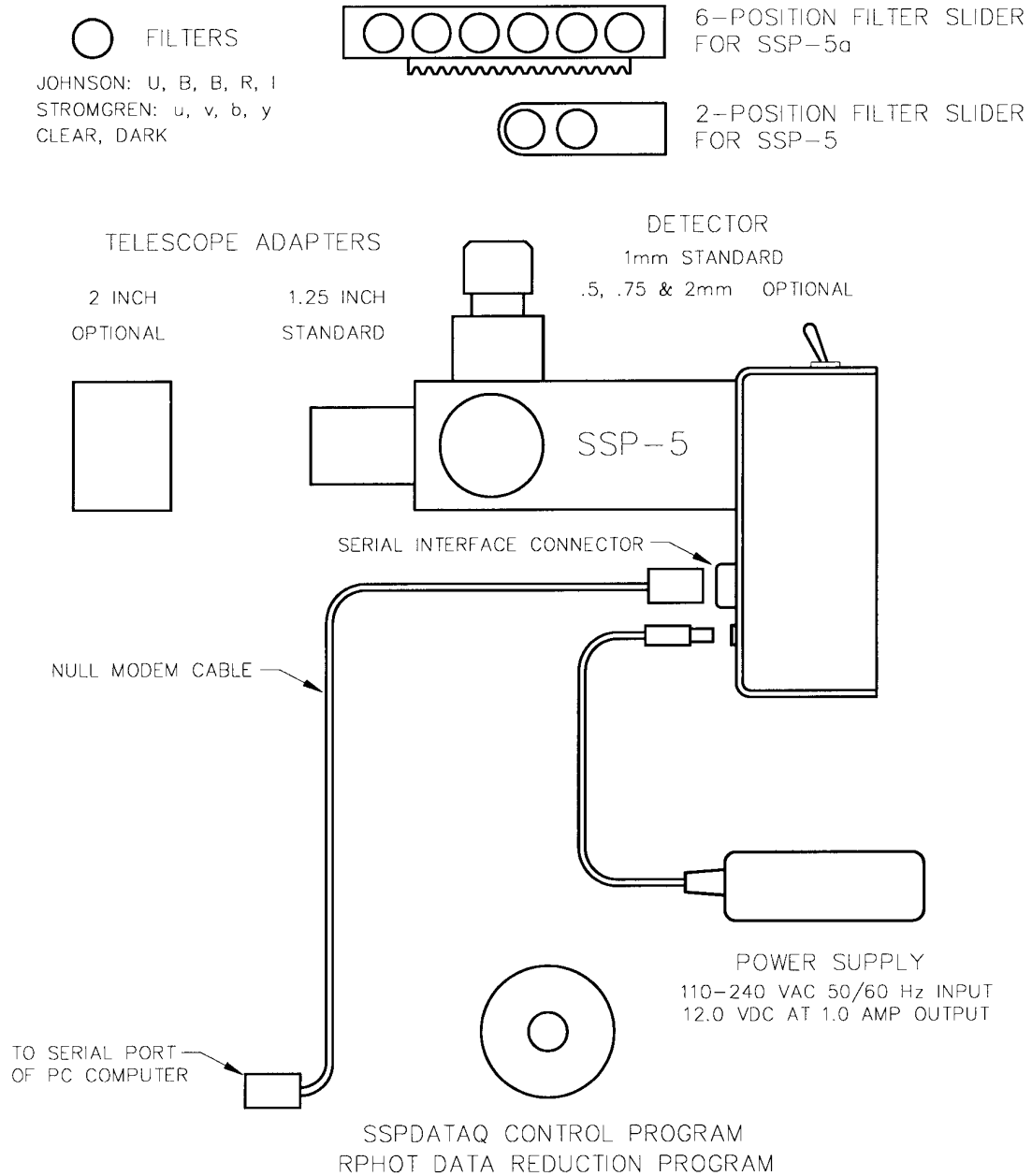

Figure 1-2. The SSP-5 photometer system and accessories.

SECTION 2.0

THEORY OF OPERATION

2.1 PHOTOMETER HEAD

A cross-sectional view of the photometer head is shown in Figure 2-1. Light enters the photometer through the 1¼-inch telescope adapter and is directed either to the focusing eyepiece or the photomultiplier tube (PMT) by means of a flip-mirror. The focusing eyepiece consists of a 1-inch focal length Ramsden and illuminated reticle with a precisely scribed ring that defines the aperture field of view. After a star is centered in the ring, the flip-mirror is rotated to allow light to pass through the aperture stop which separates the star from the background. A Fabry lens then projects an image of the primary mirror/lens onto the photocathode of the PMT.

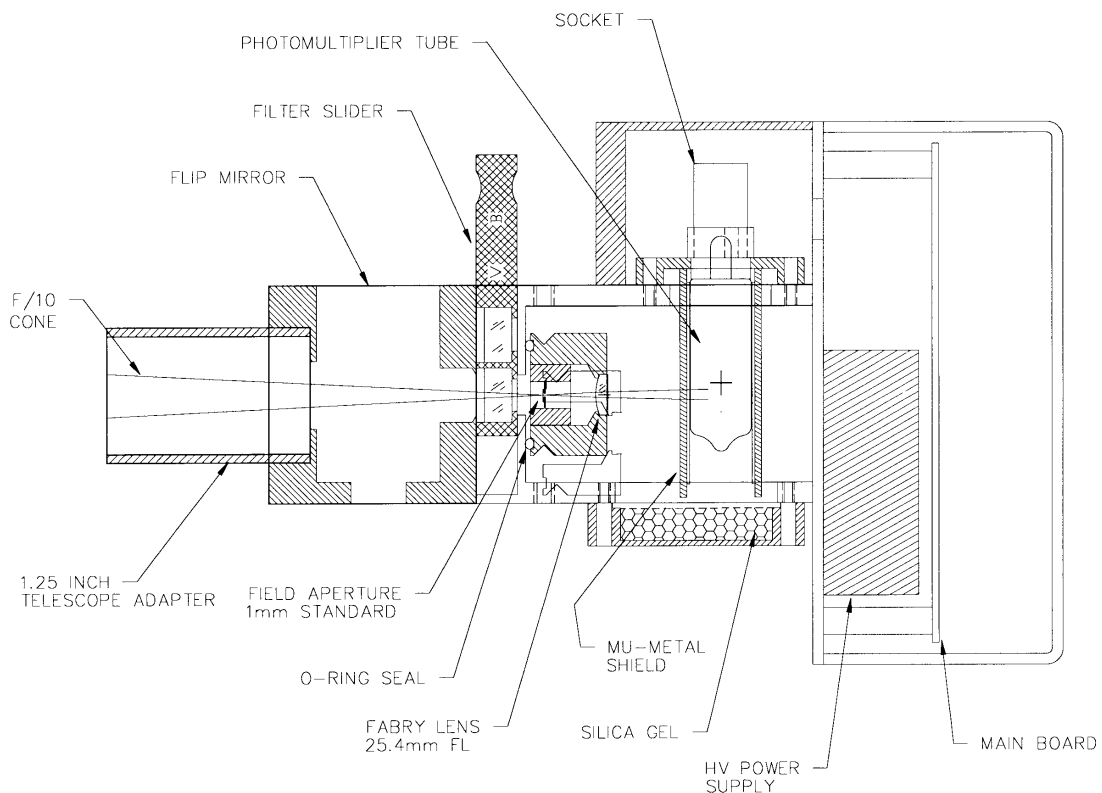

Figure 2-1. Cross-sectional view of the SSP-5 looking from the top.

2.2 DETECTOR - PMT OPTIONS

Optec currently offers two different models of side-on photomultiplier tubes (PMT's) which can be used in the SSP-5. These PMT's are manufactured by Hamamatsu Corporation and measure only 40 mm long by 13 mm in diameter. In this small package is a well designed 9-stage photomultiplier which can operate at -1000 VDC. At the operating voltage of -850 VDC and after several hours of warm-up, the model R6350 PMT has a typical measured dark current of around 8 pA at 70° F ambient temperature.

The model R6358 is an extended red response PMT that can allow measurements into the Johnson R band. The overall gain and quantum efficiency (QE) of the R6358 is much better than the R6350. The QE at the center of the Johnson V band, 540 nm, is approximately 3% for the R6350 and 17% for the R6358. Because of this increased sensitivity, when the R6358 PMT is specified the operating supply voltage is set to -750 VDC rather than -850 VDC. At this voltage, the measured dark current is typically less than 2 pA at 70° ambient temperature.

Because of the Sb-Cs photocathode material used, the spectral response of the R6350 is S-5. This is identical to the S-4 response of the traditional 1P21 tube except for extended response in the UV. The extended response to about 185 nm is due to the special UV transmitting glass used in the tube. The multialkalin material used in the R6358 photocathode surface extends the spectral response from the same 185 nm at the blue end to 830 nm at the red end. A Fabry lens of B270 glass and 2.9 mm center thickness cuts the transmission to 50% at 315 nm and to 0 at 300 nm. This small loss of UV transmission near 300 nm should not adversely affect the U filter transformation to the standard system.

The R6350 tube is powered by an -850 VDC power supply to give a current amplification of about 1×10^6 . This value was chosen after measuring the signal to dark-noise ratio at several applied voltages and using the voltage giving the highest value. Once set, the operating voltage cannot be changed by the user. When the R6358 PMT is specified, the voltage is turned down to -750 VDC. This lower voltage setting is needed to allow the user to observe brighter stars (brighter than 4th magnitude) without saturating the detector. The current amplification of the R6358 at -750 VDC is about 6×10^5 .

A mu-metal shield of high permeability is placed around the PMT to reduce the effect of external magnetic fields (dome motors, the earth's field, conductors inside the SSP-5, etc.) on the path of photoelectrons in the tube. See Figure 2-1. In addition the shield is brought to the same potential as the photocathode, so that photoelectrons are not drawn to the glass tube. To protect against shock hazard, the shield is connected to the high voltage supply through a 22 M ohm current limiting resistor.

As discussed by Miles¹ (1986) the dark current of a PMT is decreased substantially by dehumidifying the tube in a desiccating chamber. This apparently reduces current leakage around the tube pins and socket connectors to a minimum. Before assembly, the tube and socket used in

¹ Miles, R. 1986, IAPPP Communication 24, 6.

the SSP-5 are placed in a vacuum desiccator for several days before they are installed into the SSP-5. To insure continued dry operating conditions, a rechargeable silica gel canister is used as an access cover on the side of the unit. The silica gel pellets are dark blue when activated and turn pale pink when its drying ability is diminished. At that time, the silica gel canister/cover can be recharged by removing the unit (only 4 screws to take out), and baking it for 4 hours at 250° F. Additional access port covers with desiccant are available (stock #17555) for a small charge. The internal cavity of the photometer head is sealed by using silicon sealant on the non-movable parts and O-ring seals on those parts that are removable, such as the silica gel canister/access port cover.

2.3 FIELD APERTURE

As in the SSP-3, a single field aperture of either 0.5, 0.75, 1.0 or 2.0 mm diameter is placed at the focus of the telescope inside the photometer head. This aperture is not removable or changeable after assembly. Experience with the SSP-3 has indicated that the need for adjustable field apertures is not great for the vast majority of applications that usually consist of stellar brightness measurements. The focusing eyepiece contains an illuminated reticle with a scribed ring, which precisely coincides with the boundary of the field aperture. Normally, the star is centered within the ring of the focusing eyepiece and then a measurement is started by rotating the flip mirror to the measurement position - a turn of about 180 degrees.

2.4 FABRY LENS

Because the photomultiplier tube's cathode surface has very poor response uniformity, a Fabry lens is needed to fill a large area of the cathode uniformly without regard to where the star is positioned within the field aperture. Considering an f/10 cone of light as produced by a Celestron or Meade telescope, the Fabry lens used in the SSP-5 will image the telescope's entrance pupil slightly past the wire mesh screen in front of the photocathode with a spot having a diameter of 2.5 mm. Telescopes with f-ratios in the range of 7 to 20 should work with the 25.4 mm focal length Fabry lens without difficulty. The Fabry lens has a plano-convex shape and a diameter of 9 mm.

2.5 FILTERS

In addition to the standard UBVR Johnson filters, the four color (uvby) Strömgren and Hydrogen β wide and narrow filter sets are available. See Section 6.0 and 7.0 for Johnson and Strömgren filter specifications.

Filters are mounted in two-position sliders that are inserted through a side port. A spring plunger screw keeps a slight amount of pressure on the slider to keep it in place and to locate one position by a detent machined in the slider. The other position is found by pushing the filter slider in until it stops. Filters, or clear windows of identical thickness, have to be used in order to keep the focus in the same position as determined by the focusing eyepiece. Using no filter at all will move the focus up by about 2.3 mm. A black felt light seal is used on the filter slider port to prevent

external lights from being picked up by the PMT. Experience at Optec has shown that even bright office lights do not affect the output when a slider is in place and the flip mirror is in the viewing position. Removing the filter slider does cause stray light to be picked up, but not enough to trip the over voltage protection circuit to be discussed later.

The Model SSP-5A is supplied with a motorized filter slide that allows any of six filters to be selected by computer control. Filter selection cannot be made manually with the SSP-5a since the filter covers and geared drive to the stepper motor prevent any other selection except by proper activation of the stepper motor. The SSPDATAQ control program allows for selection of filters.

2.6 HIGH VOLTAGE POWER SUPPLY

For stable PMT operation an extremely well regulated and low noise high voltage power supply is needed. The gain of the PMT used in the SSP-5 is proportional to the 7th power of the applied voltage. Thus, for small values a percent change in gain is equal to 7 times the percent change in the applied voltage. For example, a 1-volt change at -850 VDC is equal to a .8% change in PMT gain, or nearly a 0.01 magnitude error. Following a 30 minute warm-up time, the voltage stability for the SSP-5 is ± 0.2 V for periods of at least 15 minutes. In the bandwidth of 1 to 0.05 Hz, the voltage noise is less than 0.1 V.

The high voltage supply (see Figure 2-2) uses a 20 kHz oscillator to drive a pot core transformer with a 1 to 55-turn ratio. A voltage doubler and rectifier circuit produces a maximum voltage of about -925 VDC when fully powered. The output is regulated down to the working voltage of -850 VDC or -750 VDC (with the R6358 PMT) by feeding a fraction of the output to a high-gain difference amplifier that compares the output to a very stable voltage reference (10ppm T-C) and amplifies the difference as a correcting voltage to the pot core voltage driver. A failure of the feedback mechanism will not overdrive the PMT causing an expensive tube replacement since the maximum voltage that can be produced is approximately -925 VDC, which is within the maximum ratings of the PMT.

In addition to the base requirement of stability, the high voltage circuitry must fit within the available space of the control box and use a minimum of power. For safety and noise constraints, the pot core transformer, high current TMOS switcher and rectifier circuit are built into a small steel enclosure with approximate dimensions of 1 x 1 x 2 inches which is mounted under the main circuit board. Power consumption of the high voltage supply is about 1.5 watts.

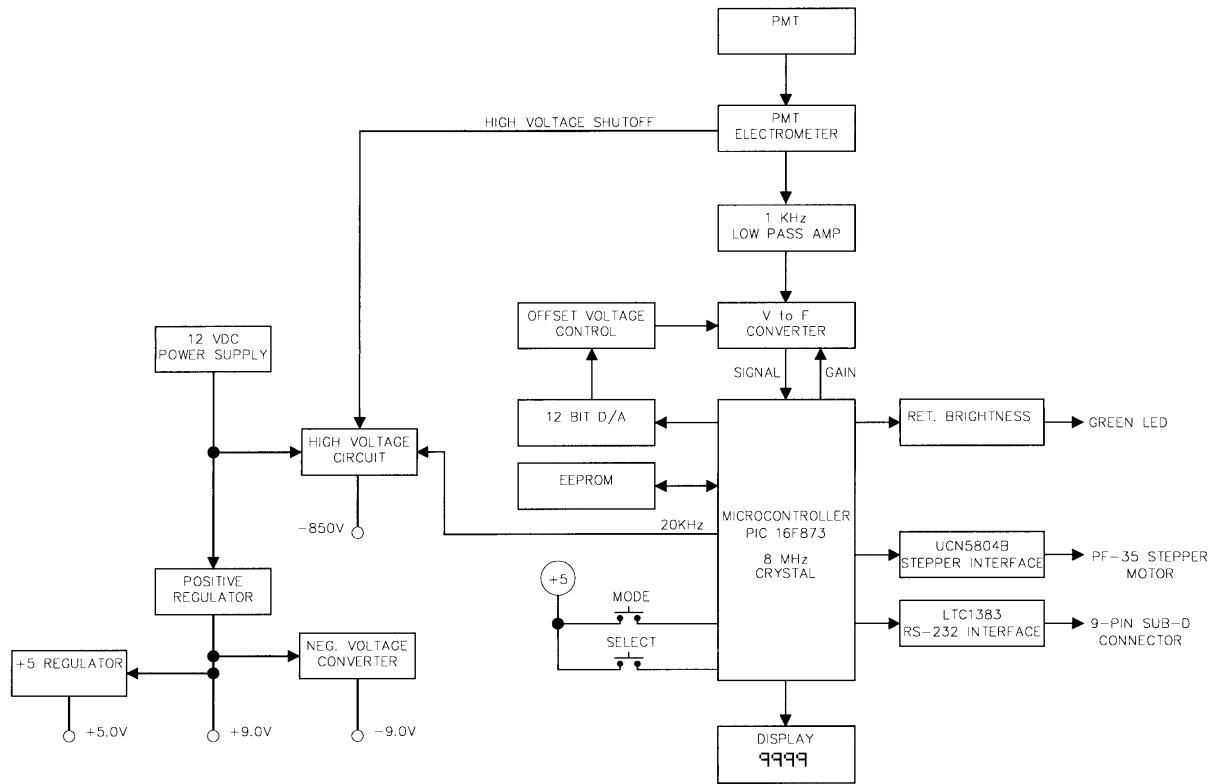

Figure 2-2. Power supply and signal processing circuit function diagram.

If the PMT is exposed to bright lights such as the moon or a bright planet, permanent damage could result to the anode stage of the tube. To prevent this, the output of the preamp is connected to a protection circuit that will turn off the high voltage within a few milliseconds when the preamp output nears its saturation point. Thus a 2nd magnitude or brighter star when observed with the V filter and 11 inch aperture telescope will trip the protection circuit and turn on an LED near the power switch. This circuit can only be reset by turning the SSP-5 completely off and then back on after a few seconds wait.

2.7 PREAMP & LOW PASS AMPLIFIER

Even with the million-fold gain of the PMT, the output current is still very small, on the order of picoamperes for dim stars. This current has to be amplified sufficiently for the V/F converter to work properly without introducing gain instabilities or noise to the output signal.

The preamp used in the SSP-5 is divided into two stages. The first stage is a current-to-voltage amplifier with a gain of 7.9×10^6 . The output voltage is related to the input current from the PMT by the following equation:

$$E_{out} = 7.9 \times 10^6 \cdot I_{in}$$

The amplifier used is an Analog Devices model 549K electrometer which has a bias current of less than 0.1 pA and noise currents much smaller. The second stage is a low pass amplifier of 1.5 gain which also inverts the signal since the V/F converter needs a negative voltage level. The total measured voltage drift is $6\mu\text{V}/^\circ\text{C}$ and output noise is less than $0.1\mu\text{V}$ in the 0.05 to 350 Hz bandwidth of interest. The response time is defined as the time taken for the output signal to go from 10% to 90% of its final value. The response time of the preamp and low pass amp combination is 1 millisecond. This rapid response allows for the measurement of stellar angular diameters by observing lunar occultations.

2.8 SIGNAL PROCESSING

The voltage signal from the low pass amplifier is processed by the voltage-to-frequency (V/F) converter to a frequency that is directly proportional to the input voltage. It is extremely linear, resulting in a laboratory measured correlation coefficient using a least squares regression of $r = 0.99995$. There is an offset adjustment available with the two-button interface that allows the user to select the output count for zero input light or dark count. It is important to set this to a positive count of around 2 to 3 with the gain set to 1 and the integration time set to 1 second. This insures that if the electrometer amplifier drifts slightly, the dark count will still be above 0. If the offset drifts to a negative value, a reading of the dark count will show 0000 on the display

Since the SSP-5 is operating in a DC mode as compared to other PMT photometers which operate in a photon (pulse) counting mode, it is important to distinguish the difference between the pulses coming from the V/F converter and the photons of light. They are not the same. This becomes very important when considering dark count. With the flip mirror in the viewing position, the 'dark' count of the SSP-5 is the sum total of PMT dark current and V/F amplifier offset voltage, which is many times higher than the dark current. The offset voltage is set high in order that there is some negative voltage going into the V/F converter at all times resulting in a count. The counter will not count backward if input noise voltages change polarity; that is, go from a negative to a positive voltage.

Gains of 1, 10 and 100 are selectable with the SSP-5. This gain control sets the signal voltage that will result in a full-scale output frequency of 10K hertz. On 1, the least sensitive gain setting, an input of -6.6 volts corresponds to 9999 counts. On the 10 and 100 gain settings, the 10K hertz V/F output corresponds to -660 mv and -66.0 mv respectively. The user can adjust the gain, much in the same way it is done with a DC amplifier/photometer, to keep the signal reading as near as possible to full scale. By doing this, errors due to quantumization become insignificant.

An integration or gate time of 1, 5 and 10 seconds is available for the SSP-5 when used in the manual mode. For most observation of variable stars, the 10-second integration time is normally selected. The 1-second integration time is used for setup only. At the conclusion of each integration period, the display will flash briefly indicating that the count has been updated.

2.9 PERFORMANCE

Testing has shown that the SSP-5 is substantially more sensitive in the UBV bands than the SSP-3 which uses a silicon photodiode. Figure 2-3 compares instrument responses in B and V. The display count is expressed in counts per second vs. magnitude for the various filters using an 11 inch aperture telescope. It should be noted that these are approximate display counts, and that accurate determinations of magnitude should be made using the accepted techniques of astronomical photometry. The lower noise limits were measured by taking the standard deviation of 10 consecutive readings at either 1 or 10 seconds of integration with no light incident on the detector. With its lower sensitivity, the SSP-3 low-light-limit shown in Figure 2-3 approximates the operational limit when using the instrument on a star since the contribution of sky and signal noise (shot noise from the star and background sky) is small compared to the instrument noise. However, these terms will effect the low light limit of the SSP-5, thus the true low light limit will be higher than what is indicated.

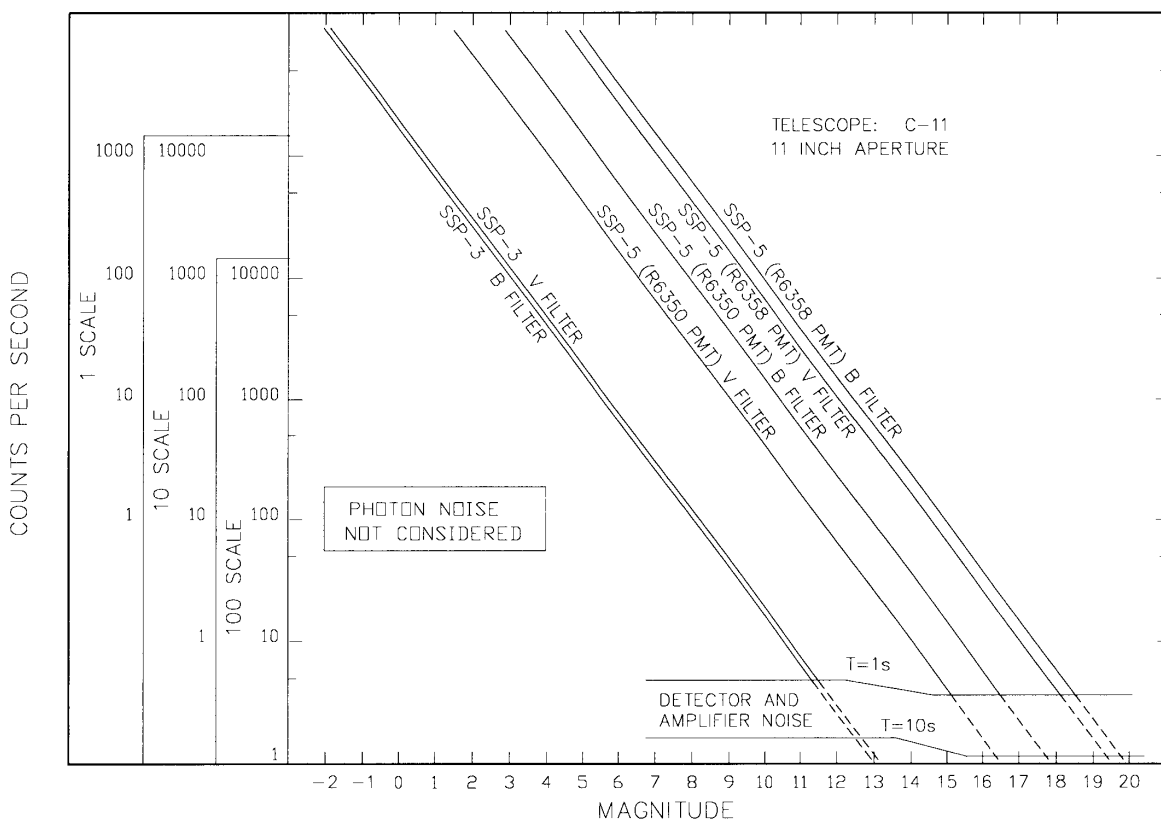

Figure 2-3. Performance of SSP-5 compared with SSP-3 which uses a silicon photodiode detector.

SECTION 3.0

OPERATING PROCEDURES

3.1 CHECK-OUT LIST

Consult Figure 3-1 for identification of the various controls and features of the SSP-5.

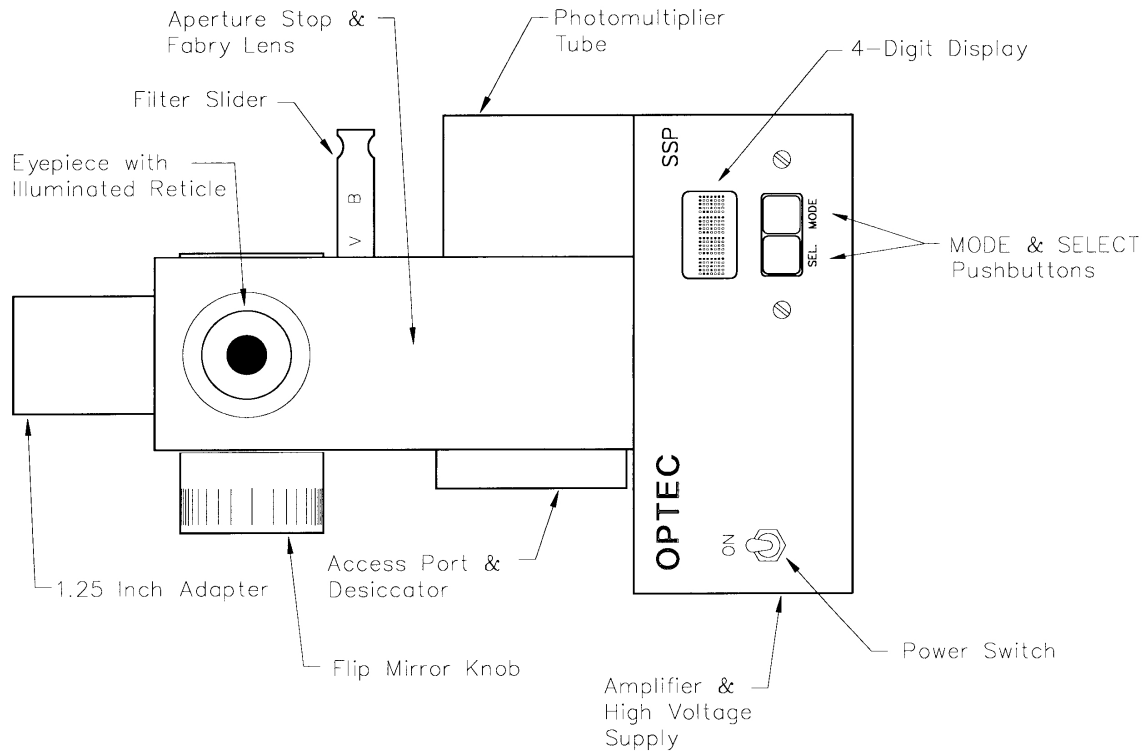

Figure 3-1. Identification of controls and features of the SSP-5 photometer.

IMPORTANT: The use of a photomultiplier tube in this photometer presents a serious shock hazard if the user is careless. If the rear cover is removed for any reason, PLEASE UNPLUG the power supply first. In addition to the possible damage that the PMT can do to the user, be attentive to the fact that serious damage can be brought on the PMT by the same carelessness. The tube should be shielded from bright lights including room lights at all times even when the power is off. NOISY TUBES AND BURNT ANODE STAGES WILL NOT BE COVERED UNDER WARRANTY TERMS. **When not used, the photometer should be stored in a dry place away from heat, vibration, lights and kids.** Remove the filter slider and clean filters, only if necessary, with a cotton swab dipped in alcohol or lens cleaning fluid. Do NOT rub hard.

Before taking readings, plug the wall-mounted power supply into an AC outlet with suitable voltage and connect the 2.5 mm mini-plug into the jack located on the control box near the bottom. Turn the photometer on and allow at least 30 minutes warm-up time at ambient observatory temperature. Make sure the filter slider is in position and the flip mirror is down so no incident light reaches the photomultiplier tube.

After warm-up, observe that the count on the 4-Digit Display with the mirror down (no light on detector) is within the range of 2 to 3 with GAIN and TIME set at 1. If readings are not within this range, adjust the OFFSET using the two button interface described below.

With the U, B and V filters, the common low wattage red lights found in most observatories that provide low-level illumination will not affect the reading if some precautions are taken to shield the telescope optics from direct illumination. However, when using R6358 PMT, the R filter can allow more than 100 times more light energy from red light to irradiate the detector. Even interior observatory surfaces that are illuminated by the red light and near the front of the telescope will affect the reading. Before taking important readings with the R filter, it is recommended that the user experiment with the illumination in his observatory to gauge the effect it will have on the SSP-5 count.

3.2 USING THE PHOTOMETER

With the mirror down, site the star or sky region in the center of the reticle. After confirming that the telescope is tracking properly, carefully flip the mirror up and record the readings.

Because of the extreme low-light sensitivity of the SSP-5, care must be taken to insure that field stars just beyond the visual limit are not within the field aperture during the measurement process as this may cause errors. For example, when using an 11-inch aperture telescope, a 15th magnitude star should be beyond the visual limit. However, if it is within the field aperture, nearly a 0.1 magnitude error could result in the measurement of a 12th magnitude star. A careful check of a photographic star atlas should be made to determine if the aperture field is clear of dim stars.

To take a star or sky brightness measurement, three consecutive readings of 10 seconds integration time (TIME set for 10) each are normally taken. Always ignore the first reading since the mirror can never be flipped up exactly at the beginning of a new 10-second cycle. After seeing the first count displayed, record the next three. After the reading sequence is completed, return the mirror to the viewing position and confirm that the star is still centered properly in the reticle. Normally, if the star is within a circle of 0.35 radius of the scribed ring center, the detector has collected more than 99% of the star's light. This rule of thumb does depend on seeing quality.

To change gain and/or integration time, hold the MODE key down until the GAIN word is displayed. Pressing the MODE key again will show the next option on the menu, which is INTG or integration time in seconds. The other MODE selections after this are OFF (offset adjustment) and RET (reticle lamp brightness). Pressing the SELECT key will allow the user to change the

values for GAIN, INTG, OFF and RET. When the selection is made using the SELECT key, press the MODE key and you will see the word DONE displayed. At that point other menu selections can be selected using the MODE key. The last item is RUN which allows the user to exit the selection menu routine and return to the operating program. When RUN is selected and the menu routine is exited, the display will remain blank until a new reading is completed. It takes a little getting used to, but with practice, the selections can be made very rapidly. There is no way in which any harm can be done to the instrument by making an improper selection.

The possible selections for GAIN are 1, 10 and 100. The possible selections for INTG are 1, 5 and 10 seconds.

IMPORTANT: In order to enter the serial program loop and use the instrument with SSPDATAQ, it is necessary that 1 second be selected for INTG.

At this point, the user has successfully completed making a reading and is referred to other sources of information about stellar photometry. The user is advised to obtain a good working knowledge of the data reduction process. However, a number of computer programs are available to simplify the data acquisition and data reduction process. For instance, Optec offers the *RPHOT Automated Data Acquisition and Reduction Software Package for Aperture Photometry*. *RPHOT* is a complete package for performing Johnson standard photometry using either "all-sky" or differential techniques. Contact Optec for additional information on *RPHOT*.

3.3 CALIBRATION AND ADJUSTMENTS

For precise determination of stellar magnitude, the filters used in the SSP-5 must be calibrated with standard stars. The procedure for doing this is beyond the scope of this manual and the user is referred to the IAPPP organization and standard texts on photometry. Simple determination of filter correction factors can be made by using a close pair of stars with a wide color temperature difference. This method is used by many members of the IAPPP and is recommended for novice users. Optec also sells a number of data reduction packages for various computers. Contact Optec for descriptive information.

The reticle and detector are critically aligned at Optec and the user should make no attempt to adjust them. If the eyepiece is removed from its mount it will be necessary to realign the field aperture, a procedure that will probably have to be done at Optec. If dust on the reticle is troublesome, remove it by blowing air (canned air for camera cleaning is suggested) through the 1.25-inch snout.

If the reticle ring needs to be adjusted in brightness, enter the menu selection by pressing and holding down the MODE key. When GAIN is seen on the display, press the MODE key again until RET is displayed. Press the SELECT key and you will see the current brightness setting. The default setting is MED (medium brightness). Press the MODE key to select another brightness. After selecting another brightness setting or if the user wishes to keep the current setting, press the SELECT key and DONE will be displayed. The user now has the option to pick another menu selection. The RUN selection will return the user to the operating program.

Offset is adjusted at Optec and should not have to be changed. However, if the instrument is used in extremely cold or hot climate, the offset may have to be adjusted. Do this adjustment in a dimly lit room with the flip mirror in the down position. Wait at least 10 minutes for the electronics to stabilize. Enter the menu selections by pressing and holding down the MODE key until GAN is seen on the display. First, select a GAIN of 10 and INTG of 1 before proceeding with the offset adjustment. Press the MODE key repeatedly until OFF is seen on the display. Press the SELECT key to show the current offset value. After a couple of seconds, a + and – symbols will appear on the display. To raise the offset, press the key under the + symbol and to lower the offset press the key under the – symbol. If the user delays more than a few seconds to make an adjustment, the display will show done and the program will return to the menu selection routine. After pressing the + or – key for making an adjustment, the display will immediately show the new offset which should change by about 3 or 4 counts. The + and – symbol will again be displayed allowing the user another opportunity to adjust the offset. Keep adjusting the offset until a value around 25 is obtained. At that point, stop and wait for the DONE to be displayed. Exit the menu selection routine after the desired INTG and GAIN values are selected.

If the photometer is exposed to a bright star, moon or other source of illumination, which exceeds the safe threshold level of the tube's anode current, the high voltage will be turned off and HV=0 will be displayed. After appropriate measures are taken to reduce the illumination levels to the photomultiplier tube, turn the power off and then back on to reset the high voltage power and continue use.

3.4 PC INTERFACE PROGRAM

The SSP-5 and 5a can be controlled with windows based program written by Optec called SSPDATAQ. This is a freeware program and the latest version can be downloaded from the Optec web site at: www.optecinc.com. Look for the software download link in the SSP-5 pages. Once installed, the integrated help file has information concerning setup and operation. SSPDATAQ controls all aspects of the SSP-5 and 5a photometers including data logging. In addition, reduction of B and V data to standard magnitude is also accomplished.

SECTION 4.0

TROUBLE-SHOOTING GUIDE

The following common problems and solutions have been collected over the years from our customers and our attempts to solve their instrument problems. Before calling us, read through these and the relevant sections of this manual to see if an easy solution exists for your errant photometer.

- 1) **Unit has been turned on and left to warm up for the proper time but no display is seen unless light is incident on the detector.**

Adjust offset as described in the previous section.

- 2) **The dark count (no light on the detector) appears to drift with time and temperature beyond what you have been accustomed to.**

This could be a moisture problem especially for observatories located in humid locations. Moisture contamination of the PMT socket pins and around the first preamp stage could cause erratic changes in the count. The photometer should always be stored in a warm dry place when not used. The desiccant contained in the side access port of the photometer head may have to be reactivated. Remove the four mounting screws holding the cover on and check to see if the small pellets still have a deep blue color. If they are a pale transparent blue or pink, bake the cover containing the pellets at a temperature of 250° F for about 4 hours. Make sure you do the work on the photometer head in a dimly lit room so as not to expose the photomultiplier tube to bright lights. Exposure to bright lights even with the power off can cause the noise counts from the tube to increase for several days. Allow the unit to stabilize for several hours at ambient temperature before measuring the drift. If the problem does not disappear or reduce to acceptable levels, it will have to be returned to Optec for repair.

- 3) **The unit seems to drift and give erratic readings with the R filter but appears to work OK with the U, B and V filters. This applies only to users with the R6358 PMT.**

The most common chip to fail on the main circuit board is the ICM7217 counter chip from Harris. Experience has shown the above symptom occurs when this chip fails in the usual way. Since the chip is socketed, the part can be easily replaced. Contact Optec for a replacement.

4) The unit appears to give much higher than expected counts every once in a while.

Any surge in the power line may cause an increase in the number of counts for the integration interval. Refrigerator compressors, dome motors, and telescope position servos could easily be the cause of this problem. Vibration and strong radio signals from nearby stations may also cause similar symptoms. Use a surge protector with RF filtering to solve the power surge problem. There is no solution for nearby radio stations.

5) The night appears clear but the star count is diminishing with time faster than expected due to changing extinction conditions.

A common problem, especially with Celestron and Meade telescopes, is that a nearly invisible film of condensed water will develop on the corrector plate or main mirror during the night if the dew point is high enough. Usually this fog film can only be seen when a strong light is projected down the front of the telescope and the optics carefully inspected. A hair dryer is the only cure.

6) As the star approaches the edge of the detector the count begins to fall but it looks as if the star is still completely within the ring as seen in the eyepiece.

The stellar light profile (energy vs. radius from the center of the star) is much larger than what is seen. On a good night a seeing disk could appear to be about 2 arc second in diameter. However, to capture over 99% of the energy a detector diameter (field aperture) of over 20 arc seconds is needed. A hazy night or a night with much greater turbulence could increase the stellar profile many more times. Thus, care must be taken to keep the star from drifting near the edge of the detector since some of the incident energy will be lost.

SECTION 5.0

SPECIFICATIONS

DETECTOR (R6350 option)

Type	9-stage side-on photomultiplier tube
Model	R6350 from Hamamatsu
Photocathode	Sb-Cs
Spectral Range	185 - 650 nm (S-5)
Cathode Sensitivity	35 mA/W at 360 nm (Johnson U band) 10 mA/W at 550 nm (Johnson V band)
Quantum Efficiency	QE=14% at 360 nm QE=3% at 540 nm
Operating Voltage	-850 V
Gain	$\approx 1 \times 10^6$ at -850 V
Rise Time	1.4 ns (PMT only)
Dark Current	≈ 8 pA at -850 V and 25° C

DETECTOR (R6358 option)

Type	9-stage side-on photomultiplier tube
Model	R6358 from Hamamatsu
Photocathode	Multialkali
Spectral Range	185 - 830 nm
Cathode Sensitivity	60 mA/W at 360 nm (Johnson U band) 70 mA/W at 550 nm (Johnson V band) 20 mA/W at 700 nm (Johnson R band)
Quantum Efficiency	QE=20% at 360 nm QE=17% at 540 nm QE=3.5% at 700 nm
Operating Voltage	-750 V
Gain	$\approx 2 \times 10^5$ at -750 V
Rise Time	1.4 ns (PMT only)
Dark Current	≈ 2 pA at -750 V and 25 C

PREAMP/LOW PASS AMPLIFIER

Type	Current-to-Voltage for 1st Stage
Bias Current	.15 pA Max.
Offset Voltage	<.25 mV
1st Stage Gain	7.9×10^6
2nd Stage Gain	1.5
Input Voltage Noise	4 μ V(p-p) (.1 to 10Hz)
Input Current Noise	.003 pA (.1 to 10Hz)
Maximum Output Voltage	-4.0 V
Operating Frequency Range	0.05 to 350 Hz
Response Time	1 msec

A/D CONVERTER

Type	Voltage-to-Frequency
Full Scale Frequency	10 KHz (13 KHz maximum)
Full Scale Input Voltages	-66 mV (100 SCALE) -660 mV (10 SCALE) -6.6 V (1 SCALE)
Linearity	<0.3%
Offset	<.5 mV (adjustable to 0)

CONTROLLER/DISPLAY

Microcontroller	16F873
Oscillator	Quartz crystal, 8.0000 MHz
Timer Accuracy	+/-25ppm at 25° C
Display	4-character, 5x7 matrix
Character Height/Color	.11 inch - Red

POWER SUPPLY

Type	AC to DC wall mount
Input Voltage	110-240 VAC, 50/60 Hz
Output Voltage	12.0 volts DC, regulated
Current Requirements	200 ma (300ma for SSP-5a)

EYEPIECE

Focal Length	25 mm
Optical Design	Ramsden
Reticle Illumination	Green LED
Field of View	0.4 degrees at 2000 mm focal length

MECHANICAL

Body Material	Aluminum 6061-T6 alloy
Finish	Bright Dip Black Anodized
Overall Length	9 inches (tip to tip)
Weight	3 lb. 6 oz.
Telescope Coupler	1.25 inch (standard)

SECTION 6.0

JOHNSON FILTERS

The UB_V filter system established by Johnson is generally followed today for photoelectric systems using a 1P21 or equivalent photomultiplier tube. This system defines wide color bands in the spectrum interval from 300 to 720 nm. Using the red-sensitive R6358 PMT, SSP-5 owners can now perform photometry into the Johnson R band. The S-5 response of the R6350 is nearly identical to the S-4 response of the original 1P21 photomultiplier tube, so the recommended filters for the R6350 most closely match Johnson's original filter specifications. However, by specifying some of the SSP-3 filters for use with the R6358 PMT, the response of this filter-detector combination can more closely match Johnson's standard UB_{VRI} response functions.

Filter-detector response is defined as the normalized product of filter transmission times detector response for each wavelength interval. Table 6-2 lists the filter-detector responses (also referred to as the response function) of the Johnson UB_{VRI} system. The filter-detector responses shown in Tables 6-3 (R6350 PMT) and 6-4 (R6358 PMT) are provided for comparison. Table 6-5 lists the filter transmission values for both SSP-5 UB_V and SSP-3 UB_{VR} filters. These values were used to calculate the filter-detector responses shown in Tables 6-2 and 6-3.

The SSP-5 UB_V filters are all made from combinations of Schott colored glass. The glass types and thickness for each filter has been computer optimized for the best fit with the Johnson standards. Table 6-1 list the physical specifications for the SSP-5 UB_V and SSP-3 UB_{VR} filters.

PHYSICAL SPECIFICATIONS	
Diameter	12.7±0.15 mm
Thickness	7.0±0.3 mm
Surface Quality	80 - 50
Flatness	2 Waves within center 6 mm
Wedge	Not to exceed 5 ARC minutes

Table 6-1. Physical characteristics of the Optec filters.

Wavelength nm	Johnson U	Johnson B	Johnson V	Johnson R	Johnson I
300	0.00	----	----	----	----
310	0.10	----	----	----	----
320	0.61	----	----	----	----
330	0.84	----	----	----	----
340	0.93	----	----	----	----
350	0.97	----	----	----	----
360	1.00	0.00	----	----	----
370	0.97	----	----	----	----
380	0.73	0.11	----	----	----
390	0.36	----	----	----	----
400	0.05	0.92	----	----	----
410	0.01	----	----	----	----
420	0.00	1.00	----	----	----
440	----	0.94	----	----	----
460	----	0.79	0.00	----	----
480	----	0.58	0.02	----	----
500	----	0.36	0.38	----	----
520	----	0.15	0.91	0.00	----
540	----	0.04	0.98	0.06	----
560	----	0.00	0.72	0.28	----
580	----	----	0.62	0.50	----
600	----	----	0.40	0.69	----
620	----	----	0.20	0.79	----
640	----	----	0.08	0.88	----
660	----	----	0.02	0.94	----
680	----	----	0.01	0.98	0.00
700	----	----	0.01	1.00	0.01
720	----	----	0.01	0.94	0.17
740	----	----	0.00	0.85	0.36
760	----	----	----	0.73	0.56
780	----	----	----	0.57	0.76
800	----	----	----	0.42	0.96
820	----	----	----	0.31	0.98
840	----	----	----	0.17	0.99
860	----	----	----	0.11	1.00
880	----	----	----	0.06	0.98
900	----	----	----	0.04	0.93
920	----	----	----	0.02	0.84
940	----	----	----	0.01	0.71
960	----	----	----	0.00	0.58
980	----	----	----	----	0.47
1000	----	----	----	----	0.36
1020	----	----	----	----	0.28
1040	----	----	----	----	0.20
1060	----	----	----	----	0.15
1080	----	----	----	----	0.10
1100	----	----	----	----	0.08
1120	----	----	----	----	0.05

Table 6-2. Standard UBVRI Response Functions According to Johnson.

wavelength nm	SSP-5 U	SSP-5 B	SSP-5 V	R6350 PMT
300	0.00	----	----	0.98
310	0.33	----	----	0.98
320	0.58	----	----	1.00
330	0.79	----	----	1.00
340	0.94	----	----	1.00
350	1.00	----	----	0.98
360	0.98	0.00	----	0.96
370	0.93	0.04	----	0.94
380	0.73	0.21	----	0.91
390	0.36	0.47	----	0.88
400	0.07	0.73	----	0.86
410	0.03	0.89	----	0.84
420	0.00	0.99	----	0.80
440	----	0.99	----	0.72
460	----	0.82	0.00	0.63
480	----	0.48	0.00	0.55
500	----	0.17	0.04	0.46
520	----	0.03	0.99	0.39
540	----	0.01	0.98	0.32
560	----	0.00	0.78	0.25
580	----	0.00	0.53	0.17
600	----	----	0.38	0.12
620	----	----	0.22	0.07
640	----	----	0.12	0.04
660	----	----	0.07	0.02
680	----	----	0.03	0.01
700	----	----	0.01	0.002
720	----	----	0.00	0.0005
740	----	----	0.00	0.0000
760	----	----	----	0.0000
780	----	----	----	0.0000
800	----	----	----	0.0000
820	----	----	----	0.0000
840	----	----	----	0.0000
860	----	----	----	0.0000
880	----	----	----	0.0000
900	----	----	----	0.0000
920	----	----	----	0.0000
940	----	----	----	0.0000
960	----	----	----	0.0000
980	----	----	----	0.0000
1000	----	----	----	0.0000
1020	----	----	----	0.0000
1040	----	----	----	0.0000
1060	----	----	----	0.0000
1080	----	----	----	0.0000
1100	----	----	----	0.0000
1120	----	----	----	0.0000

Table 6-3. R6350 Normalized Response with Response Functions of Optec UVB Filters.

Wavelength nm	SSP-3 U	SSP-3 B	SSP-3 V	SSP-3 R	R6358 PMT
300	0.00	----	----	----	0.77
310	0.00	----	----	----	0.76
320	0.00	----	----	----	0.79
330	0.15	----	----	----	0.81
340	0.40	----	----	----	0.84
350	0.61	----	----	----	0.83
360	0.92	0.05	----	----	0.86
370	1.00	0.17	----	----	0.86
380	0.82	0.36	----	----	0.86
390	0.37	0.56	----	----	0.86
400	0.00	0.71	----	----	0.86
410	0.00	0.82	----	----	0.87
420	0.00	0.94	----	----	0.89
440	----	1.00	----	----	0.91
460	----	0.76	0.00	----	0.93
480	----	0.44	0.00	----	0.95
500	----	0.26	0.59	----	0.97
520	----	0.11	0.96	0.00	1.00
540	----	0.04	1.00	0.07	0.99
560	----	0.01	0.85	0.09	0.96
580	----	0.00	0.57	0.36	0.91
600	----	----	0.29	0.71	0.86
620	----	----	0.11	0.92	0.79
640	----	----	0.03	1.00	0.71
660	----	----	0.01	0.96	0.64
680	----	----	0.00	0.86	0.57
700	----	----	0.00	0.40	0.29
720	----	----	----	0.27	0.21
740	----	----	----	0.17	0.16
760	----	----	----	0.09	0.10
780	----	----	----	0.04	0.06
800	----	----	----	0.00	0.007
820	----	----	----	0.00	0.006
840	----	----	----	0.00	0.004
860	----	----	----	0.00	0.003
880	----	----	----	0.00	0.0014
900	----	----	----	0.00	0.0000
920	----	----	----	0.00	0.0000
940	----	----	----	0.00	0.0000
960	----	----	----	0.00	0.0000
980	----	----	----	0.00	0.0000
1000	----	----	----	0.00	0.0000
1020	----	----	----	----	0.0000
1040	----	----	----	----	0.0000
1060	----	----	----	----	0.0000
1080	----	----	----	----	0.0000
1100	----	----	----	----	0.0000
1120	----	----	----	----	0.0000
1140	----	----	----	----	0.0000

Table 6-4. R6358 Normalized Response with Response Functions of Optec UBVR Filters.

Wavelength nm	SSP-5 U	SSP-5 B	SSP-5 V	SSP-3 U	SSP-3 B	SSP-3 V	SSP-3 R
300	0.08	0.00	0.00	0.00	0.00	0.00	0.00
310	0.23	0.00	0.00	0.00	0.00	0.00	0.00
320	0.40	0.00	0.00	0.00	0.00	0.00	0.00
330	0.53	0.00	0.00	0.05	0.00	0.00	0.00
340	0.64	0.00	0.00	0.20	0.00	0.00	0.00
350	0.70	0.00	0.00	0.37	0.00	0.00	0.00
360	0.71	0.00	0.00	0.46	0.01	0.00	0.00
370	0.68	0.02	0.00	0.50	0.08	0.00	0.00
380	0.54	0.10	0.00	0.41	0.24	0.00	0.00
390	0.28	0.24	0.00	0.17	0.37	0.00	0.00
400	0.04	0.39	0.00	0.00	0.48	0.00	0.00
410	0.00	0.48	0.00	0.00	0.54	0.00	0.00
420	0.00	0.56	0.00	0.00	0.60	0.00	0.00
440	0.00	0.63	0.00	0.00	0.63	0.00	0.00
460	0.00	0.60	0.00	0.00	0.58	0.00	0.00
480	0.00	0.40	0.00	0.00	0.35	0.01	0.00
500	0.00	0.17	0.03	0.00	0.13	0.53	0.00
520	0.00	0.04	0.73	0.00	0.02	0.76	0.00
540	0.00	0.01	0.88	0.00	0.01	0.75	0.07
560	0.00	0.00	0.92	0.00	0.00	0.62	0.47
580	0.00	0.00	0.92	0.00	0.00	0.42	0.63
600	0.00	0.00	0.92	0.00	0.00	0.20	0.71
620	0.00	0.00	0.92	0.00	0.00	0.09	0.74
640	0.00	0.00	0.92	0.00	0.00	0.02	0.72
660	0.00	0.00	0.92	0.00	0.00	0.00	0.68
680	0.00	0.00	0.92	0.00	0.00	0.00	0.59
700	0.01	0.00	0.92	0.00	0.00	0.00	0.49
720	0.15	0.00	0.92	0.00	0.00	0.00	0.40
740	0.30	0.00	0.92	0.00	0.00	0.00	0.32
760	----	----	----	0.00	0.00	0.00	0.26
780	----	----	----	0.00	0.00	0.00	0.21
800	----	----	----	0.00	0.00	0.00	0.15
820	----	----	----	0.00	0.00	0.00	0.11
840	----	----	----	0.00	0.00	0.00	0.08
860	----	----	----	0.00	0.00	0.00	0.06
880	----	----	----	0.00	0.00	0.00	0.05
900	----	----	----	0.00	0.00	0.00	0.03
920	----	----	----	0.00	0.00	0.00	0.02
940	----	----	----	0.00	0.00	0.00	0.01
960	----	----	----	0.00	0.00	0.00	0.01
980	----	----	----	0.00	0.00	0.00	0.01
1000	----	----	----	0.00	0.00	0.00	0.01
1020	----	----	----	0.00	0.00	0.00	0.00
1040	----	----	----	0.00	0.00	0.00	0.00
1060	----	----	----	0.00	0.00	0.00	0.00
1080	----	----	----	0.00	0.00	0.00	0.00
1100	----	----	----	0.00	0.00	0.00	0.00
1120	----	----	----	0.00	0.00	0.00	0.00

Table 6-5. Transmission of the Optec SSP-5 UBVR and SSP-3 UBVR filters.

SECTION 7.0

STRÖMGREN FILTERS

The Strömgren uvby is the most widely used intermediate-band photometric system. The letters u, v, b, y refer to the colors ultraviolet, violet, blue and yellow respectively. Because these filters have a narrow passband, the system is totally filter defined, and variations in detector spectral response, telescope transmission, and the second order terms used for the extinction corrections and the transformation equations can be safely ignored. In addition, the use of these filters provides more useful astrophysical information than the Johnson UBV system. Table 7-1 lists the filter specifications.

The vby filters are multiple cavity interference type using dielectric quarter wave stacks with spacers of metal film. They have excellent transmission characteristic and long life when properly stored. However, all interference filters can be damaged when exposed to high humidity for long periods of time. When not used, these filters should be stored in a glass jar with a small amount of desiccant added to keep the air dry. In such an environment, these filters will last virtually forever.

OPTICAL SPECIFICATIONS			
Filter	Center Wavelength	Bandpass	Type
u	342 nm	25 nm	6mm UG11 + 1mm WG345
v	410±2 nm	16±1.6 nm	interference
b	470±2 nm	19±1.9 nm	interference
y	550±2 nm	24±2.4 nm	interference

Table 7-1. Optical specifications of Strömgren filters.

The u filter is made from 2 pieces of Schott colored glass. The first glass of UG11 defines the red side of the pass band and the WG345 defines the blue side. The red leak of the UG11 glass beyond 700 nm should not be a source of error with the R6350 PMT since the spectral response is extremely small at that wavelength and redder. The surface of the UG11 glass has poor resistance to weathering (humidity) and must be protected in a manner similar to the vby filters. Unlike the interference filters, which cannot be restored, the weathered surface of this filter can be repolished. If a small amount of weathering is observed, a white haze on the surface, a Q-tip with jeweler's rouge and water can normally repolish the surface. Use light pressure and blow-dry the filter immediately afterwards.

PHYSICAL SPECIFICATIONS	
Diameter	12.7±0.15 mm
Thickness	7.0±0.3 mm
Surface Quality	80-50
Wedge	Not to exceed 5 ARC minutes

Table 7-2. Physical specifications of Strömgren filters.

Appendix A

MOTORIZED FILTER BAR OPTION

A motorized filter slider option can be added to the SSP-5 to make it an SSP-5a. This allows the SSPDATAQ (freeware) program to select filters under program control. A Noppon model PF35 stepper motor is added to the instrument to operate the filter slider. The slider can hold up to six of the ½” diameter filters in any order the user wishes. Filters must be mounted by Optec since it involves sealing the filters in place with a RTV compound. Filters can be removed if necessary.

The filter slider is first HOMED by moving the slider a sufficient number of steps in one direction until the slider bottoms out on the filter cover. This defines position one. From that position, the other 5 positions can be found by moving the slider the appropriate number of steps. Each filter position is 33 steps apart. Approximate time to move from one filter to the next is 0.5 seconds. A UCN5804B driver chip is used to interface to the stepper motor. With SSPDATAQ, it is necessary to select the AUTO mode in the setup menu.

Description	Value
Number of Phases	4
Step Angle (full step)	7.5 degrees
Holding Torque	2.8 oz.-in.
Operating Temperature	-25 to +50 °C
DC Operating Voltage	12 volts
Resistance per Winding	70Ω

Table A-1. Specifications for Model PF35-48C Stepper Motor from Nippon.

Appendix B

DETERMINATION OF FIELD APERTURE ANGULAR SIZE

The SSP-5 and SSP-3 photometers offer a fixed aperture which must be selected at initial purchase. In most instances the standard field aperture of 1mm diameter is best suited. However, 0.5mm, 0.75mm and 2mm field apertures are also offered optionally.

To determine the angular size of each field aperture with a particular telescope, refer to Table B-1 below. Remember that even though the seeing disk of a star may appear as small as 2arc seconds, the stellar profile may be many times larger. A good rule of thumb is to ensure the star's image remains within the central 70% of the field aperture to ensure that 99% of the stellar energy falls upon the detector. The reader is referred to section 9.4 of *Astronomical Photometry* by Henden & Kaitchuck (Optec stock no. 17330) for a full discussion of diaphragm selection and stellar profiles.

Another important consideration in selecting an aperture size is the accuracy of the telescope mounting system. Periodic errors (as well as erratic errors) can cause the star to drift within the field. Your aperture must be large enough to ensure that the star remains within the center of the detector field of view for the duration of the photometer integration period, typically 10 to 60 seconds.

TELESCOPE FOCAL (Common Configurations)	DETECTOR APERTURE SIZE			
	0.5mm	0.75mm	1.0mm	2.0mm
1280 mm (8 inch f/6.3)	81"	121"	161"	322"
1600 mm (10 inch f/6.3)	64"	97"	129"	258"
2000 mm (17½ inch f/4.5)	52"	77"	103"	206"
2032 mm (8 inch f/10)	51"	76"	101"	203"
2540 mm (10 inch f/10)	41"	61"	81"	162"
2794 mm (11 inch f/10)	37"	55"	74"	148"
3912 mm (14 inch f/11)	26"	40"	53"	105"

Table B-1. Angular Size of Common Telescope/Aperture Combinations in Arc Seconds.

Appendix C
WIRING DIAGRAM

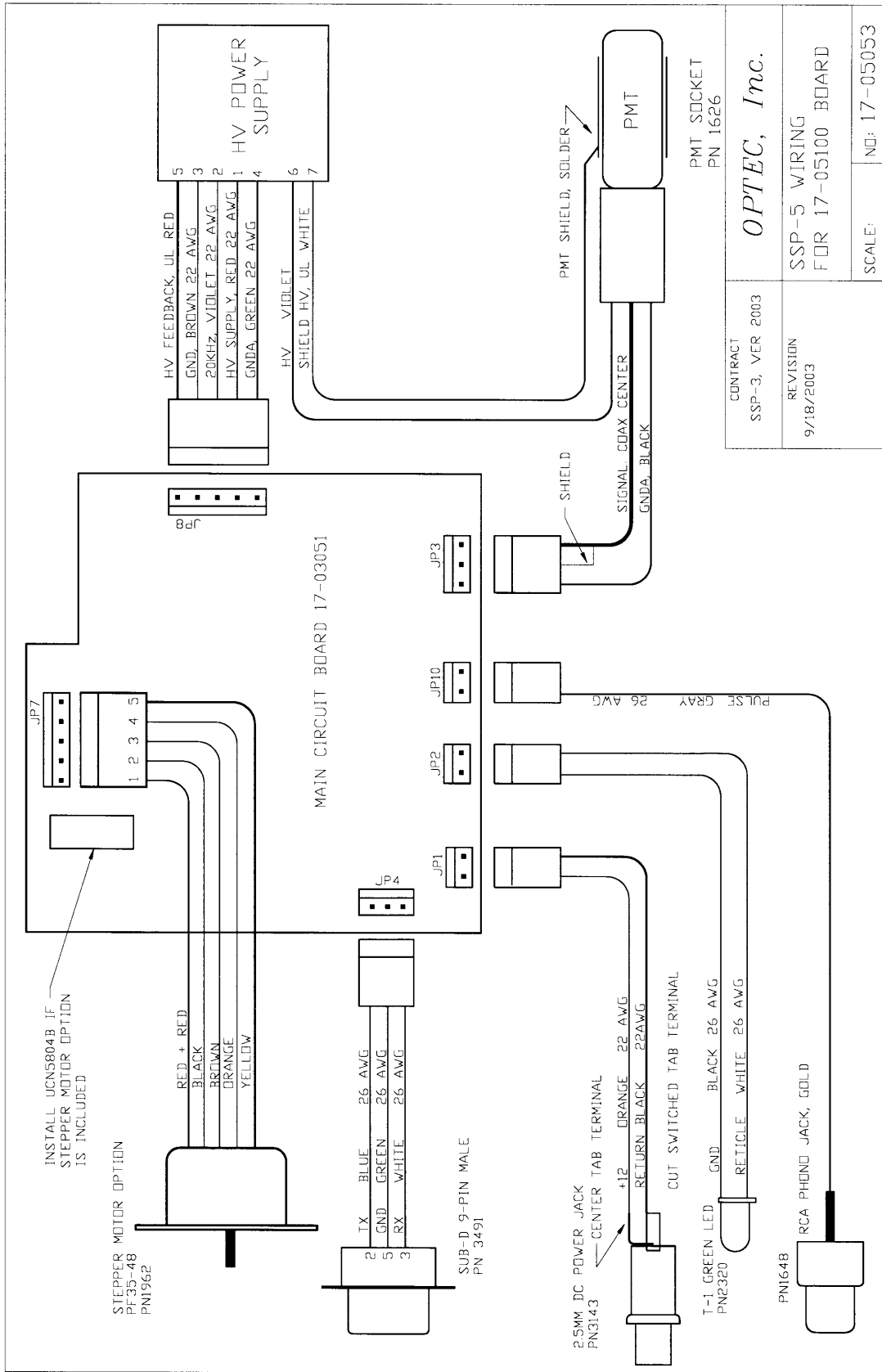

Appendix D

MAIN CIRCUIT DIAGRAM

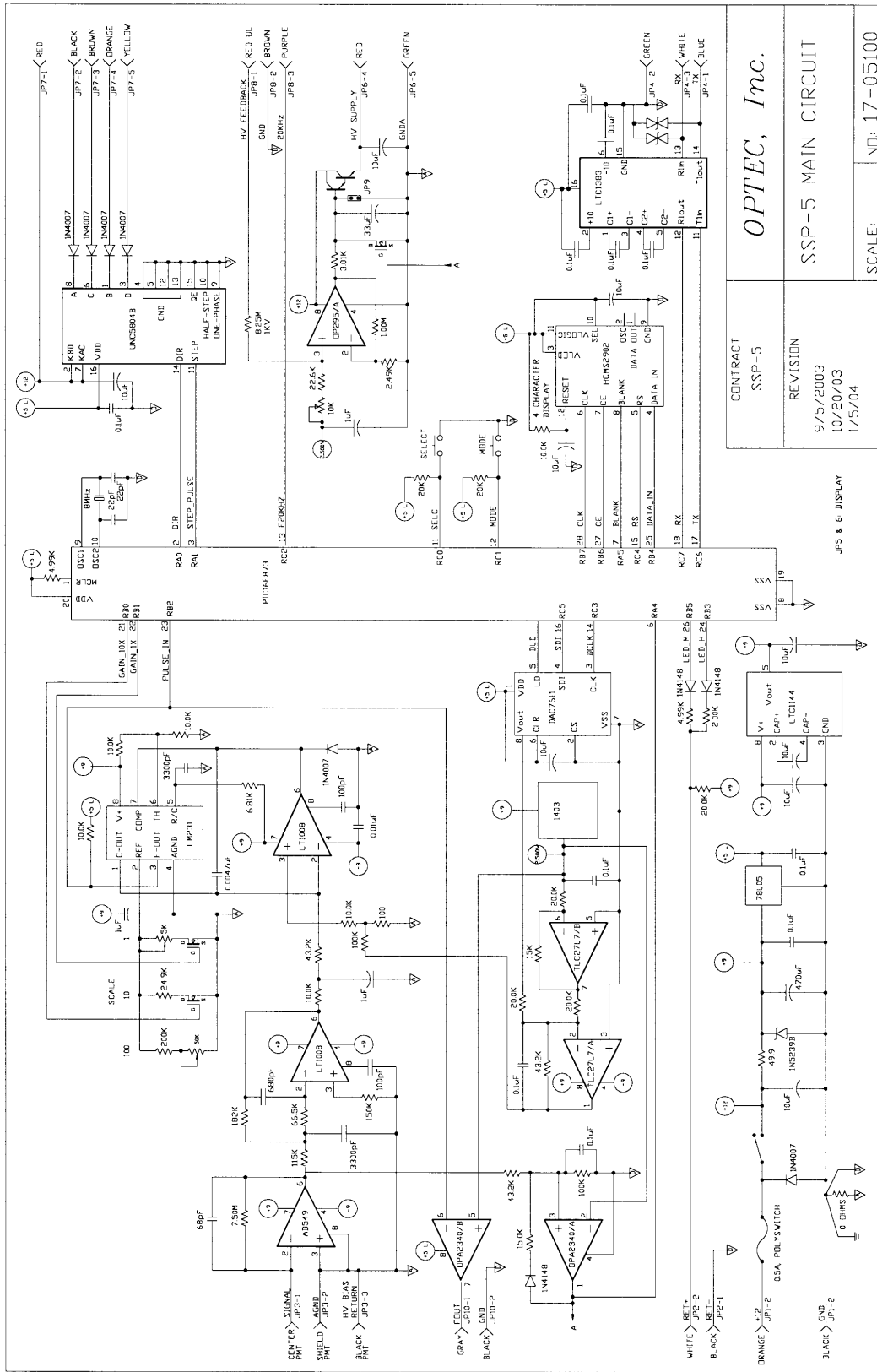

CONTRACT SSP-5		OPTEC, Inc.	
REVISION 9/5/2003 10/20/03 1/5/04		SSP-5 MAIN CIRCUIT	
SCALE: JPS & 6 DISPLAY		NO: 17-05100	

Appendix E

SAMPLE DATA ENTRY FORM

The sample report form printed on the back cover is useful for recording data when using the differential photometry technique. Basically, this method is to compare the brightness of the variable star to that of a nearby comparison star, which is known to have no variability. No attempt is made here to educate the user in all aspects of proper observing procedure and the associated data reduction. A number of texts about astronomical photometry are available which describe the proper methodology.

Figure C-1 shows an observing report for the night of September 18-19, 1984, of Nova Vulpecula and the comparison star HD182618. Observations were made with the V filter using an 11 inch aperture telescope.

VAR. __NOVA__	DOUBLE DATE __Sept. 18-19, 2004__
COMP. __HD 182618__	PAGE ____ OF ____

OBSERVER __J.P.____	NOTES _____
TELESCOPE __C-11____	_____
CONDITIONS __GOOD____	_____

UT	STAR	FILTER	SCALE	TIME	COUNT	SKY	COMMENTS
1::21	COM P	V	10	10	894	402	
					891	402	
					594	401	
1:24	NOVA	V	10	10	509		
					507		
					510		
1.:29	COM P	V	10	10	881		
					880		
					877		
					.		
					.		
					.		

Figure C-1. Sample Data Entry Using the Report Form.

VAR _____	DOUBLE DATE _____
COMP. _____	PAGE ____ OF _____

OBSERVER _____	NOTES _____
TELESCOPE _____	_____
CONDITIONS _____	_____

UT	STAR	FILTER	SCALE	TIME	COUNT	SKY	COMMENTS

Appendix F
PMT TUBE DATA

New Electro-Optical Design 13mm (1/2 Inch) Diameter, 9-stage, Side-on Type

Our new electro-optic construction allows Hamamatsu to introduce an improved line of compact side-on PMTs. The X-axis anode uniformity full width half maximum (FWHM) is greater than existing models. This wider "sweet" spot increases detection efficiency and can make optical alignment easier.

The R6357 is a unique addition, it is the new meshless multialkali compact PMT having over 100mA/W photocathode radiant sensitivity.

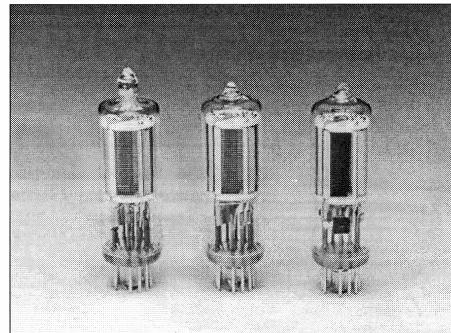

▲ Left: Quartz window Center: UV window
Right: Meshless type (R6357)

APPLICATIONS

- Emission Spectroscopy (ICP, Direct Reader)
- Environmental Monitoring (NO_x, SO₂, etc.)
- Fluorescence Immunoassay
- Chemiluminescence Immunoassay
- Hygiene Monitor (Bio Luminescence)
- X-ray Phototimer
- Fluorometer
- Microscope (Laser Scanning Microscope)

Subject to local technical requirements and regulations, availability of products included in this promotional material may vary. Please consult with our sales office.
Information furnished by HAMAMATSU is believed to be reliable. However, no responsibility is assumed for possible inaccuracies or omissions. Specifications are subject to change without notice. No patent rights are granted to any of the circuits described herein. © 1998 Hamamatsu Photonics K.K.

NEW COMPACT TYPE PMT SERIES

Side-On New Compact Type Photomultiplier Tubes

Type No.	Remarks	Spectral Response		Photo-cathode Material [Ⓐ]	Window Material [Ⓑ]	Outline No. [Ⓒ]	Dynode Structure [Ⓓ]	Socket Socket Assembly	Maximum Ratings [Ⓕ]		Cathode Sensitivity [Ⓖ]	
		Range (nm)	Peak Wave-length (nm)						Anode to Cathode Voltage (Vdc)	Average Anode Current (mA)	Luminous	
				Min. (μA/lm)	Typ. (μA/lm)							
R6350	For UV to visible range, general purpose.	185 to 650	340	Sb-Cs	U	1	CC/9	E678-11U/Ⓔ	1250	0.01	20	40
R6351	Synthetic silica window type of R6350	160 to 650	340	Sb-Cs	Q	2	CC/9	E678-11U/Ⓔ	1250	0.01	20	40
R6352	High sensitivity variant of R6350	185 to 750	420	BA	U	1	CC/9	E678-11U/Ⓔ	1250	0.01	80	120
R6353	Low dark current bialkali photocathode	185 to 680	400	LBA	U	1	CC/9	E678-11U/Ⓔ	1250	0.01	30	70
R6354	For UV range	160 to 320	230	Cs-Te	Q	2	CC/9	E678-11U/Ⓔ	1250	0.01	—	—
R6355	For UV to near IR range, general purpose	185 to 850	530	MA	U	1	CC/9	E678-11U/Ⓔ	1250	0.01	80	150
R6356	High sensitivity variant of R6355	185 to 900	600	MA	U	1	CC/9	E678-11U/Ⓔ	1250	0.01	140	250
R6357 *	High sensitivity variant of R6356, Meshless type	185 to 900	450	MA	U	1	CC/9	E678-11U/Ⓔ	1250	0.01	350	500
R6358	Low dark current variant of R6356	185 to 830	530	LMA	U	1	CC/9	E678-11U/Ⓔ	1250	0.01	140	200

* Achieved the higher photocathode sensitivity by eliminating the mesh in front of the photocathode. It also features no output variation, disturbed by the mesh, when the incident light spot to the photocathode is small.

- NOTE**
- Ⓐ Photocathode materials
BA: Bialkali
LBA: Low dark current bialkali
MA: Multialkali
LMA: Low dark current multialkali
 - Ⓑ Window materials
Q: Synthetic silica
U: UV glass
 - Ⓒ Outline No. See Fig. 9
 - Ⓓ Dynode structure
CC: Circular-cage
 - Ⓔ See optional accessories
 - Ⓕ The maximum ambient temperature range is -80 to +50°C.
 - Ⓖ Averaged over any interval of 30 seconds maximum.

Figure 1: Typical Spectral Response of Cs-Te

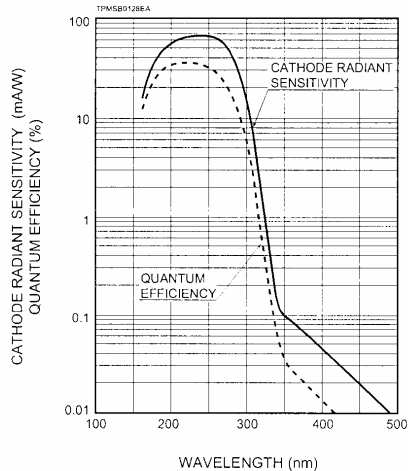
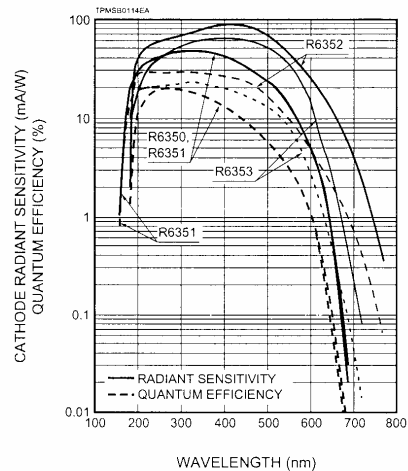

Figure 2: Typical Spectral Response of BA, LBA, Sb-Cs



Cathode Sensitivity			Anode Characteristics								Notes	Type No.	
Blue (5-58) Typ. (μA/lm-b)	Red/White Ratio Typ.	Radiant Typ. (mA/W)	Anode to Cathode Supply Voltage (Vdc)	Anode Sensitivity			Current Amplification Typ.	Anode Dark Current (After 30 min.)		Time Response			
				Min. (A/lm)	Typ. (A/lm)	Radiant Typ. (nm)		Typ. (nA)	Max. (nA)	Rise Time Typ. (ns)			Electron Transit Time Typ. (ns)
5	—	48	1000	50	300	3.6×10^5	7.5×10^6	0.5	5	1.4	15	Photon counting type: R6350P: 10cps Typ.	R6350
5	—	48	1000	50	300	3.6×10^5	7.5×10^6	0.5	5	1.4	15		R6351
10	—	90	1000	100	700	5.2×10^5	5.8×10^6	1	10	1.4	15		R6352
6.5	—	65	1000	100	400	3.7×10^5	5.7×10^6	0.1	2	1.4	15	Photon counting type: R6353P: 10cps Typ.	R6353
—	—	62 ^a	1000	—	—	1.8×10^5 ^a	3×10^6	0.5	5	1.4	15		R6354
6	0.15	45	1000	100	600	1.8×10^5	4×10^6	1	10	1.4	15		R6355
7	0.3	60	1000	400	2500	6×10^5	1×10^7	1	10	1.4	15		R6356
13	0.4	105	1000	1000	2000	4.2×10^5	4×10^6	2	10	1.4	15		R6357 *
7.5	0.15	70	1000	300	700	2.5×10^5	3.5×10^6	0.1	1	1.4	15	Photon counting type: R6358P: 20cps Typ.	R6358

^a Measured using red filter Toshiba R-68.

¹ Measured at the peak wavelength.

² Refer to Note 1.

^a at 254nm

³ Anode characteristics are measured with the supply voltage and voltage distribution ratio specified by Note 1.

⁴ Voltage distribution ratio and voltage.

Electrodes	K	Dy1	Dy2	Dy3	Dy4	Dy5	Dy6	Dy7	Dy8	Dy9	P
Distribution Ratio	1	1	1	1	1	1	1	1	1	1	1

Supply Voltage: 1000Vdc, K: Cathode, Dy: Dynode, P: Anode

Figure 3: Typical Spectral Response of MA, LMA

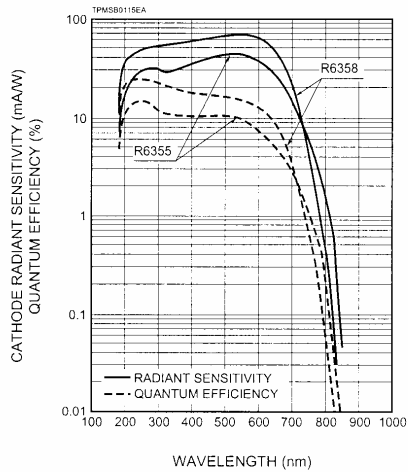

Figure 4: Typical Spectral Response of High Sensitivity MA

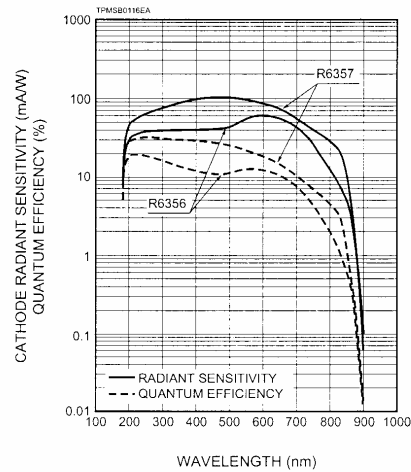

Figure 5: Typical Current Amplification

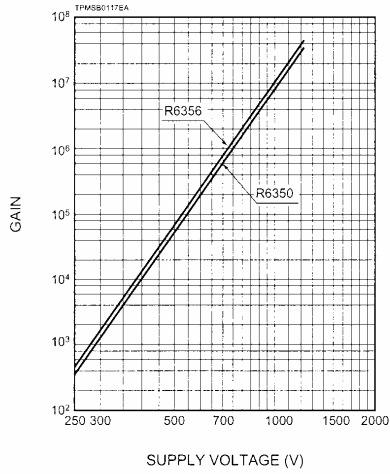

Figure 6: Typical Time Response

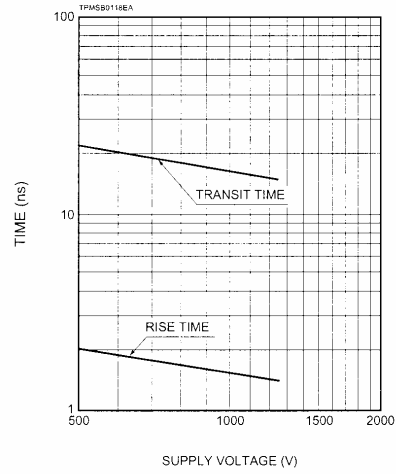

Figure 7: Typical ENI Characteristics

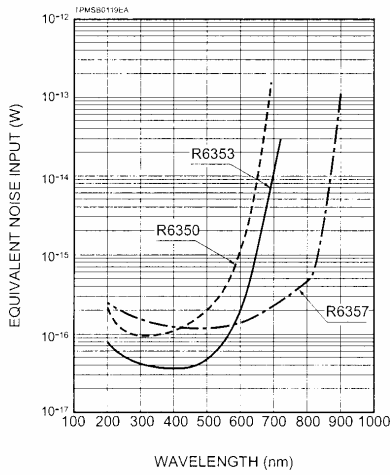
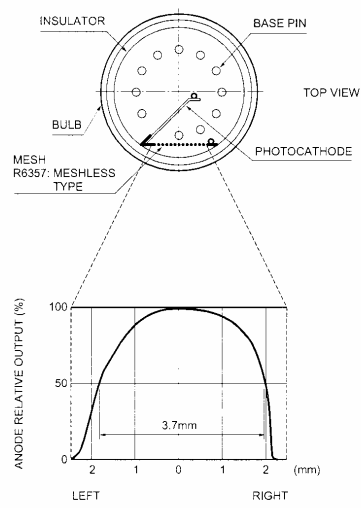
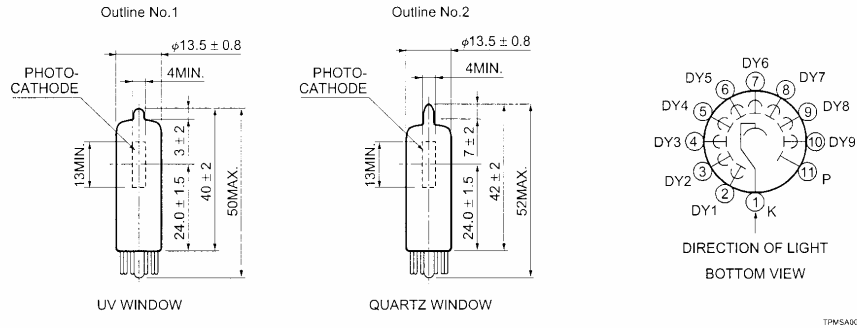

Figure 8: Typical Anode Uniformity



TPMS0036EA

Figure 9: Dimensional Outline and Basing Diagram (Unit: mm)



Socket

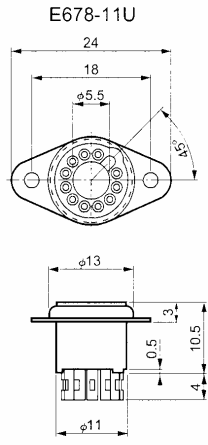

TACCA0191EA

E678-11T (Option):
For direct soldering to PC board

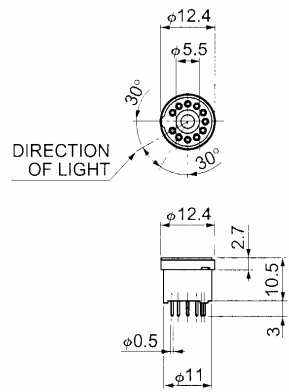

TACCA0161EA

Remaining Hamamatsu Photonics 1/2" side on PMT anode cap types and compact types will be discontinued by the year 2000. We recommend the new compact types instead of those current in use.

■ Correlation among anode cap type, current compact type and new compact type

TYPE/GRADE	ANODE CAP TYPE	CURRENT COMPACT TYPE	NEW COMPACT TYPE
Sb-Cs/UV	R300/R444	R1414/R1413	R6350
Sb-Cs/Q	R306	R1656	R6351
BA/UV HIGH	—	R5785	R6352
LBA/UV	—	R2371	R6353
MA/UV	R889	R1547/R1546	R6355
MA/UV HIGH	—	R3823	R6356
MA/UV HIGH	—	R3823-03	R6357
LMA/UV	—	R4457	R6358
Cs-Te/Q	R427	R1657	R6354

NOTE UV: UV WINDOW, Q: QUARTZ WINDOW, HIGH: HIGH SENSITIVITY

NEW COMPACT TYPE PMT SERIES

Optional Accessories

D-Type Socket Assembly

Type No.	Ground Potential Electrode	Maximum Ratings [Ⓐ]			Leakage Current in Signal Max. (A)	Total Voltage Divider Resistance (MΩ)	Maximum Linear Output in DC Mode (μA)	Signal Output
		Supply Voltage between Case and Pins (Vdc)	Supply Voltage between Power Supply Terminals (Vdc)	Voltage Divider Current (mA)				
E850-13 [Ⓔ]	Anode	1500	1250	0.38	5×10^{-10}	3.3	15 (at 1000V)	DC/Pulse

E850-22: with SHV, BNC connector

- NOTE [Ⓐ] Measured with the maximum supply voltage.
[Ⓑ] Measured with a supply voltage of 1000V.
[Ⓒ] The current at which the output linearity is kept within $\pm 5\%$.
[Ⓓ] Operating temperature range -20 to +50°C.
[Ⓔ] Supplied with a separate mounting flange. See below for assembled dimensions.

Dimensional Outline and Circuit Diagram (Unit: mm)

E850-13

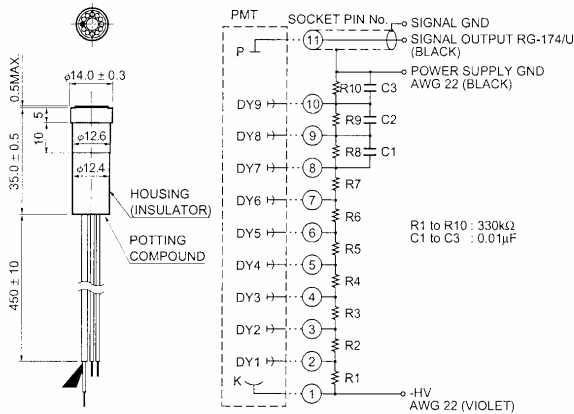

TACCA096EA

Mounting Flange for E850-13

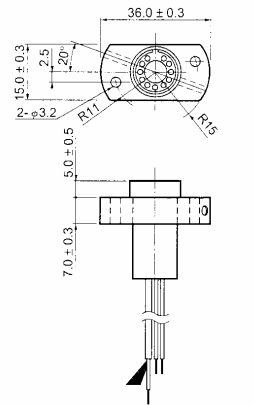

TACCA097EB

⚠ WARNING ~High Voltage~

The product is operated at high voltage potential. Further, the metal housing of the product is connected to the photocathode (potential) so that it becomes a high voltage potential when the product is operated at a negative high voltage (anode grounded). Accordingly, extreme safety care must be taken for the electrical shock hazard to the operator or the damage to the other instruments.

HAMAMATSU

HAMAMATSU PHOTONICS K.K., Electron Tube Center
 314-5, Shimokanzo, Toyooka-village, Iwata-gun, Shizuoka-ken, 438-0193, Japan, Telephone: (81)539/62-5248, Fax: (81)539/62-2205
 U.S.A.: Hamamatsu Corporation, 360 Foothill Road, P. O. Box 6910, Bridgewater, N.J. 08607-0910, U.S.A., Telephone: (1)908-231-0960, Fax: (1)908-231-1218
 Germany: Hamamatsu Photonics Deutschland GmbH, Arzbergerstr. 10, D-82211 Herrsching am Ammersee, Germany, Telephone: (49)8152-375-0, Fax: (49)8152-2658
 France: Hamamatsu Photonics France S.A.R.L., 8, Rue du Saule Trépu, Parc du Moulin de Massy, 91882 Massy Cedex, France, Telephone: (33)1 69 53 71 00, Fax: (33)1 69 53 71 10
 United Kingdom: Hamamatsu Photonics UK Limited, Lough Point, 2 Gladbeck Way, Windmill Hill, Enfield, Middlesex EN2 7JA, United Kingdom, Telephone: (44)181-367-6384
 North Europe: Hamamatsu Photonics Norden AB, Farogatan 7, S-164-40 Kista Sweden, Telephone: (46)8-703-29-50, Fax: (46)8-750-58-95
 Italy: Hamamatsu Photonics Italia S.R.L., Strada della Moia, 1/E, 20020 Arese, (Milano), Italy, Telephone: (39)02-935 81 733, Fax: (39)02-935 81 741

TPMS1032E03
 OCT. 1998 JF
 Printed in Japan (1000)

Appendix G

SSP FIRMWARE COMMAND SET

```
'=====serial mode commands
'
'      19.2K baud, no parity, inverted, always driven
'
'      n   is any real integer 0 <= n <= 9
'      x   is any character
'      LF  is a line feed character, decimal 10, hex A
'      CR  is a carriage return character, decimal 13, hex D
'      "!" is the exclamation character, decimal 33, hex 21
'
' SSMODE  if in manual mode, this command will initiate the serial loop mode and
'          after serial commands will control the instrument
'          after the serial loop mode is entered, a "!" LF CR is sent on the
'          serial port to acknowledge the mode change
'          if the instrument is already in the serial loop mode, the
'          acknowledgement code is sent again, "!" LF CR to confirm that the
'          instrument is in the serial loop mode
'
' SGAINn  sets gain of instrument of preamp stage. n can be 1, 2 or 3 only
'          1 = gain of 100, 2 = gain of 10, 3 = gain of 100
'          "!" LF CR is returned on serial port to acknowledge command
'
' SInnnn  sets integration time in units of 0.01 seconds. 0001 <= nnnn <= 9999
'          "!" LF CR is returned on serial port to acknowledge command
'
' SCOUNT  start a reading with selected gain and integration time.
'          after the count is completed, the results are displayed on the
'          instrument and sent on the serial port in the following format:
'          C=nnnnn LF CR, where 00000 <= nnnnn <= 65535, leading zeros are sent
'
' SMnnnn  initiate a fast reading cycle with selected gain and integration time.
'          nnnn is the number of readings to do, 0000 <= nnnn <= 9999, leading
'          zeros must be added for number to be correct
'          after each reading is done the value is sent on the serial in the
'          following format: nnnn LF CR where 0000 <= nnnn <= 9999
'          the fast mode sequence can be interrupted by sending a SS
'          once the fast mode is successfully stopped, a "!" LF CR is sent
'
' SFILtn  if the auto filter option is available on the instrument, the filter
'          number can be selected. n can be 1, 2, 3, 4, 5 or 6 only.
'          once the filter move is complete a "!" LF CR is sent
'
' SHOMEx  if the auto filter option is available on the instrument, this command
'          makes the filter slider find position 1 and stay there.
'          once the filter move is complete a "!" LF CR is sent
'
' SENDxx  exits the serial loop mode and returns to manual mode.
'          before leaving the serial loop mode, an "END" LF CR is sent
'
'=====serial error messages
'
' "ER=1" LF CR  low battery voltage condition is sent at any time that the
'               instrument detects a low voltage on the battery - SSP-3 only
'
' "ER=2" LF CR  high voltage has shut down because of object to bright - SSP-5 only
```